



## N-Channel Enhancement-Mode Vertical DMOS FET

### Features

- ▶ Low threshold - 2.0V max.
- ▶ High input impedance
- ▶ Low input capacitance - 100pF typical
- ▶ Fast switching speeds
- ▶ Low on-resistance
- ▶ Free from secondary breakdown
- ▶ Low input and output leakage
- ▶ Complementary N- and P-channel devices

### Applications

- ▶ Logic level interfaces - ideal for TTL and CMOS
- ▶ Solid state relays
- ▶ Battery operated systems
- ▶ Photo voltaic drives
- ▶ Analog switches
- ▶ General purpose line drivers
- ▶ Telecom switches

### General Description

This low threshold, enhancement-mode (normally-off) transistor utilizes a vertical DMOS structure and Supertex's well-proven, silicon-gate manufacturing process. This combination produces a device with the power handling capabilities of bipolar transistors and the high input impedance and positive temperature coefficient inherent in MOS devices. Characteristic of all MOS structures, this device is free from thermal runaway and thermally-induced secondary breakdown.

Supertex's vertical DMOS FETs are ideally suited to a wide range of switching and amplifying applications where very low threshold voltage, high breakdown voltage, high input impedance, low input capacitance, and fast switching speeds are desired.

### Ordering Information

Device	Package Option	BV <sub>DSS</sub> /BV <sub>DGS</sub> (V)	R <sub>DS(ON)</sub> (max) (Ω)	I <sub>D(ON)</sub> (min) (A)	V <sub>GS(th)</sub> (max) (V)
	TO-92				
TN0610	TN0610N3-G	100	1.5	3.0	2.0

-G indicates package is RoHS compliant ('Green')



### Absolute Maximum Ratings

Parameter	Value
Drain-to-source voltage	BV <sub>DSS</sub>
Drain-to-gate voltage	BV <sub>DGS</sub>
Gate-to-source voltage	±20V
Operating and storage temperature	-55°C to +150°C
Soldering temperature*	300°C

Absolute Maximum Ratings are those values beyond which damage to the device may occur. Functional operation under these conditions is not implied. Continuous operation of the device at the absolute rating level may affect device reliability. All voltages are referenced to device ground.

\* Distance of 1.6mm from case for 10 seconds.

### Pin Configurations

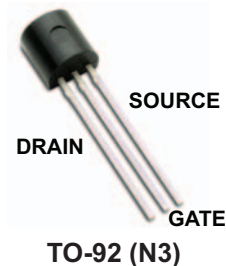

### Product Marking

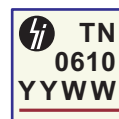

YY = Year Sealed  
 WW = Week Sealed  
 \_\_\_\_\_ = "Green" Packaging

**TO-92 (N3)**

### Thermal Characteristics

Package	I <sub>D</sub> (continuous) <sup>†</sup> (mA)	I <sub>D</sub> (pulsed) (A)	Power Dissipation @T <sub>c</sub> = 25°C (W)	θ <sub>jc</sub> (°C/W)	θ <sub>ja</sub> (°C/W)	I <sub>DR</sub> <sup>†</sup> (mA)	I <sub>DRM</sub> (A)
TO-92	500	3.2	1.0	125	170	500	3.2

**Notes:**

<sup>†</sup> I<sub>D</sub> (continuous) is limited by max rated T<sub>J</sub>.

### Electrical Characteristics (T<sub>A</sub> = 25°C unless otherwise specified)

Sym	Parameter	Min	Typ	Max	Units	Conditions
BV <sub>DSS</sub>	Drain-to-source breakdown voltage	100	-	-	V	V <sub>GS</sub> = 0V, I <sub>D</sub> = 1.0mA
V <sub>GS(th)</sub>	Gate threshold voltage	0.6	-	2.0	V	V <sub>GS</sub> = V <sub>DS</sub> , I <sub>D</sub> = 1.0mA
ΔV <sub>GS(th)</sub>	Change in V <sub>GS(th)</sub> with temperature	-	-	-4.5	mV/°C	V <sub>GS</sub> = V <sub>DS</sub> , I <sub>D</sub> = 1.0mA
I <sub>GSS</sub>	Gate body leakage	-	-	100	nA	V <sub>GS</sub> = ± 20V, V <sub>DS</sub> = 0V
I <sub>DSS</sub>	Zero gate voltage drain current	-	-	10	μA	V <sub>GS</sub> = 0V, V <sub>DS</sub> = Max Rating
		-	-	1.0	mA	V <sub>DS</sub> = 0.8 Max Rating, V <sub>GS</sub> = 0V, T <sub>A</sub> = 125°C
I <sub>D(ON)</sub>	On-state drain current	1.2	2.0	-	A	V <sub>GS</sub> = 5.0V, V <sub>DS</sub> = 25V
		3.0	6.7	-		V <sub>GS</sub> = 10V, V <sub>DS</sub> = 25V
R <sub>DS(ON)</sub>	Static drain-to-source on-state resistance	-	-	15	Ω	V <sub>GS</sub> = 3.0V, I <sub>D</sub> = 250mA
		-	1.5	2.0		V <sub>GS</sub> = 5.0V, I <sub>D</sub> = 750mA
		-	1.0	1.5		V <sub>GS</sub> = 10V, I <sub>D</sub> = 750mA
ΔR <sub>DS(ON)</sub>	Change in R <sub>DS(ON)</sub> with temperature	-	-	0.75	%/°C	V <sub>GS</sub> = 10V, I <sub>D</sub> = 750mA
G <sub>FS</sub>	Forward transductance	400	500	-	mmho	V <sub>DS</sub> = 25V, I <sub>D</sub> = 1.0A
C <sub>ISS</sub>	Input capacitance	-	100	150	pF	V <sub>GS</sub> = 0V, V <sub>DS</sub> = 25V, f = 1.0MHz
C <sub>OSS</sub>	Common source output capacitance	-	50	85		
C <sub>RSS</sub>	Reverse transfer capacitance	-	10	35		
t <sub>d(ON)</sub>	Turn-on delay time	-	-	6	ns	V <sub>DD</sub> = 25V, I <sub>D</sub> = 1.5A, R <sub>GEN</sub> = 25Ω
t <sub>r</sub>	Rise time	-	-	14		
t <sub>d(OFF)</sub>	Turn-off delay time	-	-	16		
t <sub>f</sub>	Fall time	-	-	16		
V <sub>SD</sub>	Diode forward voltage drop	-	0.8	1.8	V	V <sub>GS</sub> = 0V, I <sub>SD</sub> = 1.5A
t <sub>rr</sub>	Reverse recovery time	-	300	-	ns	V <sub>GS</sub> = 0V, I <sub>SD</sub> = 1.5A

**Notes:**

1. All D.C. parameters 100% tested at 25°C unless otherwise stated. (Pulse test: 300μs pulse, 2% duty cycle.)
2. All A.C. parameters sample tested.

### Switching Waveforms and Test Circuit

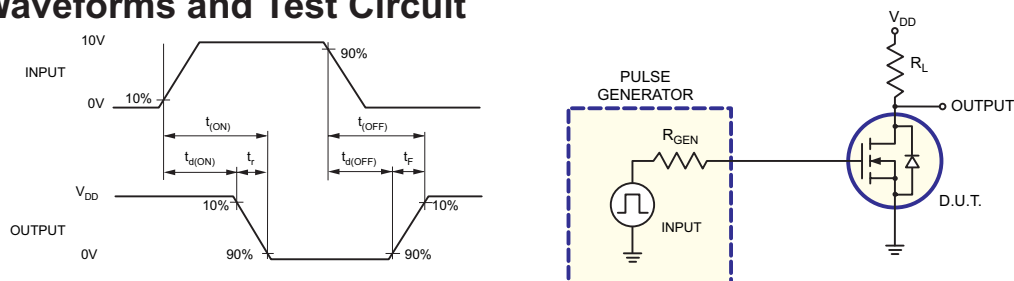

# Typical Performance Curves

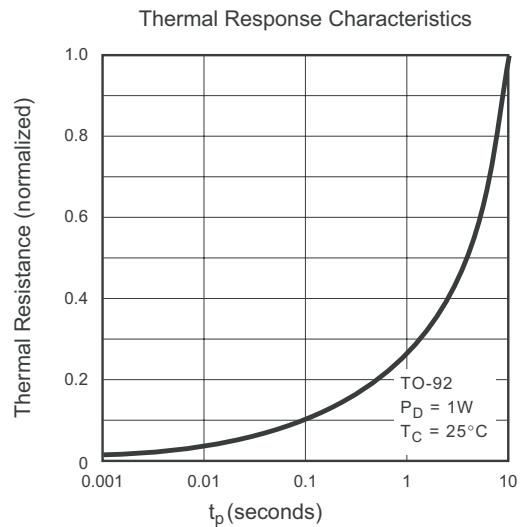
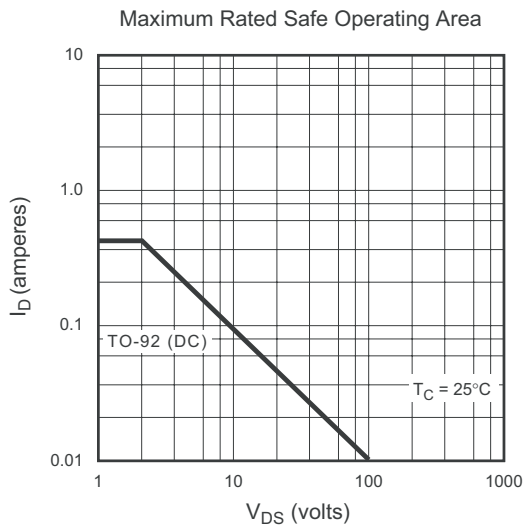
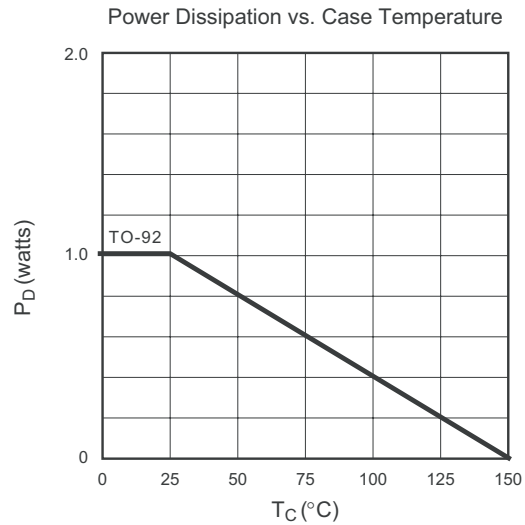
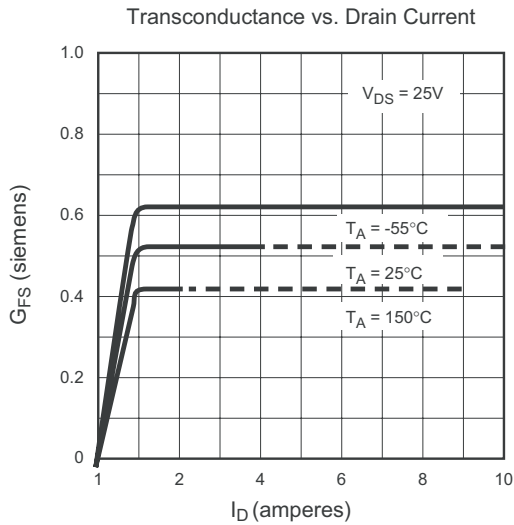
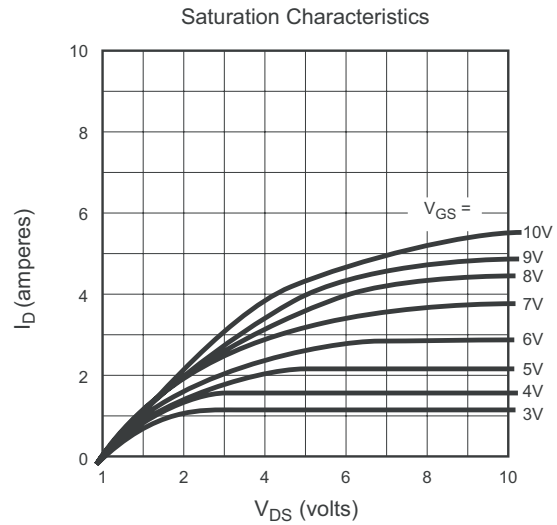
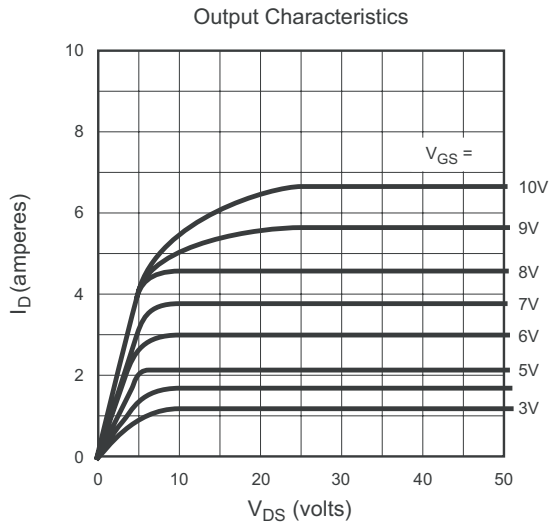

Typical Performance Curves (cont.)

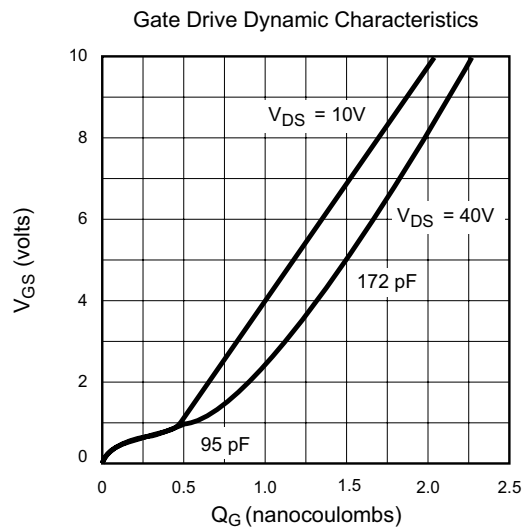
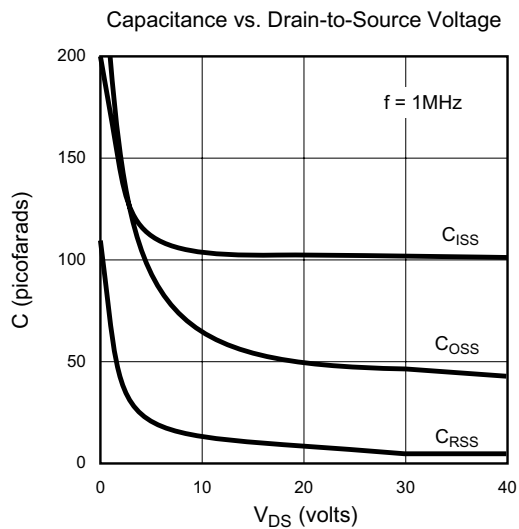
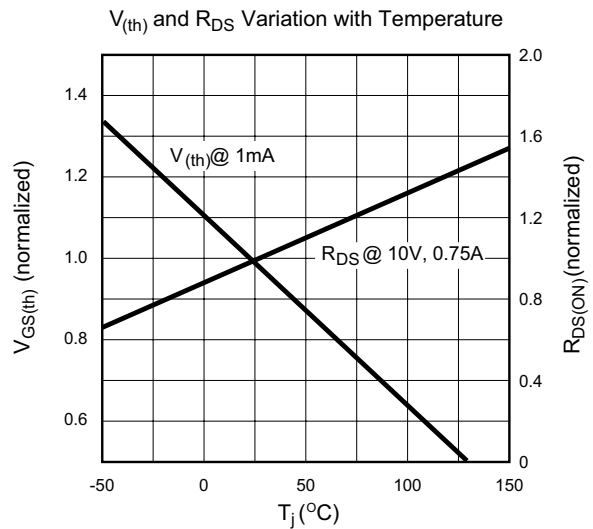
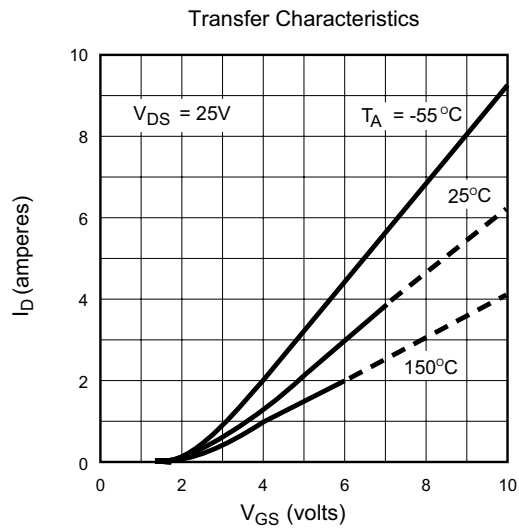
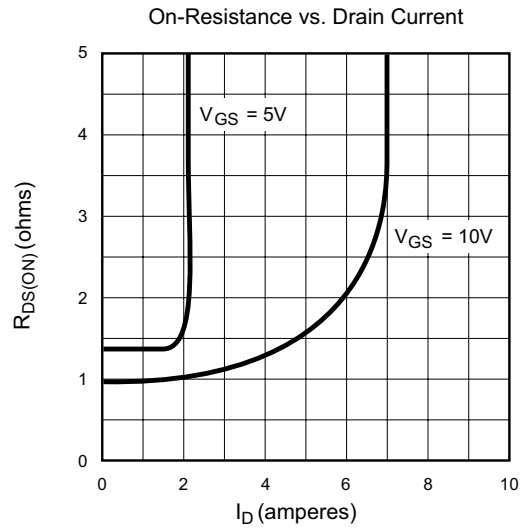
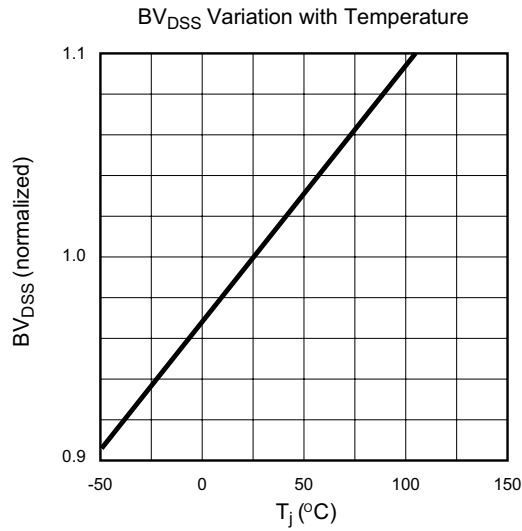

### 3-Lead TO-92 Package Outline (N3)

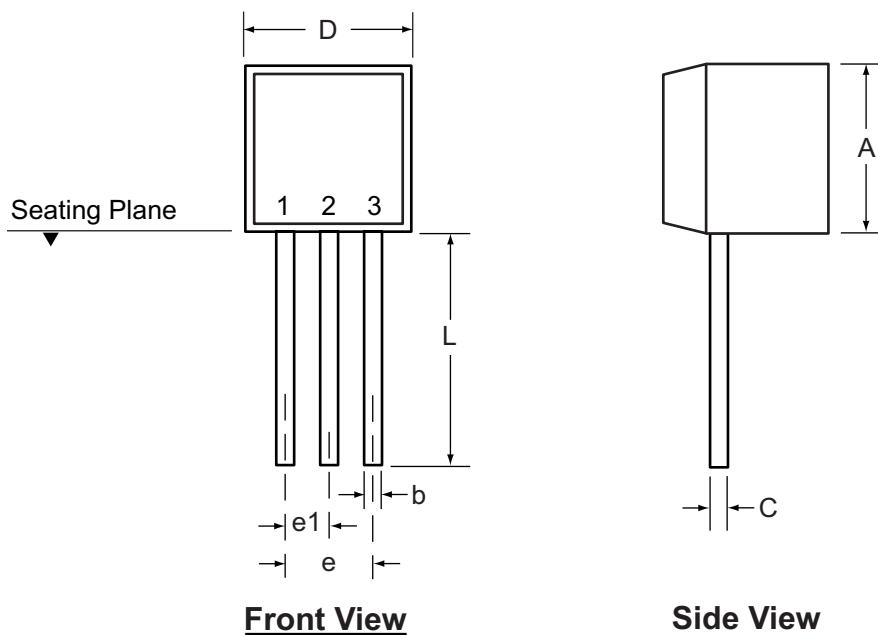

Symbol		A	b	C	D	E	E1	e	e1	L
Dimension (inches)	MIN	.170	.014	.014	.175	.125	.080	.095	.045	.500
	NOM	-	-	-	-	-	-	-	-	-
	MAX	.210	.022	.022	.205	.165	.105	.105	.055	-

Drawings not to scale.

(The package drawing(s) in this data sheet may not reflect the most current specifications. For the latest package outline information go to <http://www.supertex.com/packaging.html>.)

**Supertex inc.** does not recommend the use of its products in life support applications, and will not knowingly sell its products for use in such applications, unless it receives an adequate "product liability indemnification insurance agreement". **Supertex** does not assume responsibility for use of devices described and limits its liability to the replacement of the devices determined defective due to workmanship. No responsibility is assumed for possible omissions or inaccuracies. Circuitry and specifications are subject to change without notice. For the latest product specifications, refer to the **Supertex** website: <http://www.supertex.com>.

©2008 **Supertex inc.** All rights reserved. Unauthorized use or reproduction is prohibited.

**Supertex inc.**  
 1235 Bordeaux Drive, Sunnyvale, CA 94089  
 TEL: (408) 222-8888 / FAX: (408) 222-4895  
[www.supertex.com](http://www.supertex.com)