

SIPMOS[®] Power Transistor

- N channel
- Enhancement mode
- Avalanche-rated

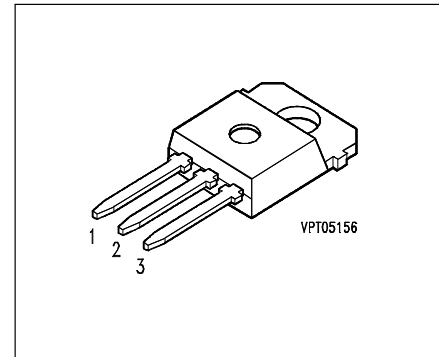

Pin 1	Pin 2	Pin 3
G	D	S

Type	V _{DS}	I _D	R _{DS(on)}	Package	Ordering Code
BUZ 355	800 V	6 A	1.5 Ω	TO-218 AA	C67078-S3107-A2

Maximum Ratings

Parameter	Symbol	Values	Unit
Continuous drain current <i>T_C</i> = 29 °C	<i>I_D</i>	6	A
Pulsed drain current <i>T_C</i> = 25 °C	<i>I_{Dpuls}</i>	24	
Avalanche current, limited by <i>T_{jmax}</i>	<i>I_{AR}</i>	5.1	
Avalanche energy, periodic limited by <i>T_{jmax}</i>	<i>E_{AR}</i>	15	mJ
Avalanche energy, single pulse <i>I_D</i> = 6 A, <i>V_{DD}</i> = 50 V, <i>R_{GS}</i> = 25 Ω <i>L</i> = 37.5 mH, <i>T_j</i> = 25 °C	<i>E_{AS}</i>	720	
Gate source voltage	<i>V_{GS}</i>	± 20	V
Power dissipation <i>T_C</i> = 25 °C	<i>P_{tot}</i>	125	W
Operating temperature	<i>T_j</i>	-55 ... + 150	°C
Storage temperature	<i>T_{stg}</i>	-55 ... + 150	
Thermal resistance, chip case	<i>R_{thJC}</i>	≤ 1	K/W
Thermal resistance, chip to ambient	<i>R_{thJA}</i>	75	
DIN humidity category, DIN 40 040		E	
IEC climatic category, DIN IEC 68-1		55 / 150 / 56	

Electrical Characteristics, at $T_j = 25^\circ\text{C}$, unless otherwise specified

Parameter	Symbol	Values			Unit
		min.	typ.	max.	
Static Characteristics					
Drain- source breakdown voltage $V_{GS} = 0\text{ V}$, $I_D = 0.25\text{ mA}$, $T_j = 25\text{ }^\circ\text{C}$	$V_{(BR)DSS}$	800	-	-	V
Gate threshold voltage $V_{GS}=V_{DS}$, $I_D = 1\text{ mA}$	$V_{GS(th)}$	2.1	3	4	
Zero gate voltage drain current $V_{DS} = 800\text{ V}$, $V_{GS} = 0\text{ V}$, $T_j = 25\text{ }^\circ\text{C}$ $V_{DS} = 800\text{ V}$, $V_{GS} = 0\text{ V}$, $T_j = 125\text{ }^\circ\text{C}$	I_{DSS}	-	-	1	μA
Gate-source leakage current $V_{GS} = 20\text{ V}$, $V_{DS} = 0\text{ V}$	I_{GSS}	-	10	100	nA
Drain-Source on-resistance $V_{GS} = 10\text{ V}$, $I_D = 3.9\text{ A}$	$R_{DS(on)}$	-	0.9	1.5	Ω

Electrical Characteristics, at $T_j = 25^\circ\text{C}$, unless otherwise specified

Parameter	Symbol	Values			Unit
		min.	typ.	max.	
Dynamic Characteristics					
Transconductance $V_{DS} \geq 2 * I_D * R_{DS(on)max}$, $I_D = 3.9 \text{ A}$	g_{fs}	2.5	6.8	-	S
Input capacitance $V_{GS} = 0 \text{ V}$, $V_{DS} = 25 \text{ V}$, $f = 1 \text{ MHz}$	C_{iss}	-	1750	2350	pF
Output capacitance $V_{GS} = 0 \text{ V}$, $V_{DS} = 25 \text{ V}$, $f = 1 \text{ MHz}$	C_{oss}	-	190	290	
Reverse transfer capacitance $V_{GS} = 0 \text{ V}$, $V_{DS} = 25 \text{ V}$, $f = 1 \text{ MHz}$	C_{rss}	-	100	150	
Turn-on delay time $V_{DD} = 30 \text{ V}$, $V_{GS} = 10 \text{ V}$, $I_D = 2.1 \text{ A}$ $R_{GS} = 50 \Omega$	$t_{d(on)}$	-	25	40	ns
Rise time $V_{DD} = 30 \text{ V}$, $V_{GS} = 10 \text{ V}$, $I_D = 2.1 \text{ A}$ $R_{GS} = 50 \Omega$	t_r	-	130	200	
Turn-off delay time $V_{DD} = 30 \text{ V}$, $V_{GS} = 10 \text{ V}$, $I_D = 2.1 \text{ A}$ $R_{GS} = 50 \Omega$	$t_{d(off)}$	-	400	530	
Fall time $V_{DD} = 30 \text{ V}$, $V_{GS} = 10 \text{ V}$, $I_D = 2.1 \text{ A}$ $R_{GS} = 50 \Omega$	t_f	-	130	175	

Electrical Characteristics, at $T_j = 25^\circ\text{C}$, unless otherwise specified

Parameter	Symbol	Values			Unit
		min.	typ.	max.	
Reverse Diode					
Inverse diode continuous forward current $T_C = 25^\circ\text{C}$	I_S	-	-	4	A
Inverse diode direct current, pulsed $T_C = 25^\circ\text{C}$	I_{SM}	-	-	16	
Inverse diode forward voltage $V_{GS} = 0\text{ V}, I_F = 12\text{ A}$	V_{SD}	-	0.95	1.4	V
Reverse recovery time $V_R = 100\text{ V}, I_F = I_S, di_F/dt = 100\text{ A}/\mu\text{s}$	t_{rr}	-	0.3	-	μs
Reverse recovery charge $V_R = 100\text{ V}, I_F = I_S, di_F/dt = 100\text{ A}/\mu\text{s}$	Q_{rr}	-	2.5	-	μC

Power dissipation

$$P_{\text{tot}} = f(T_C)$$

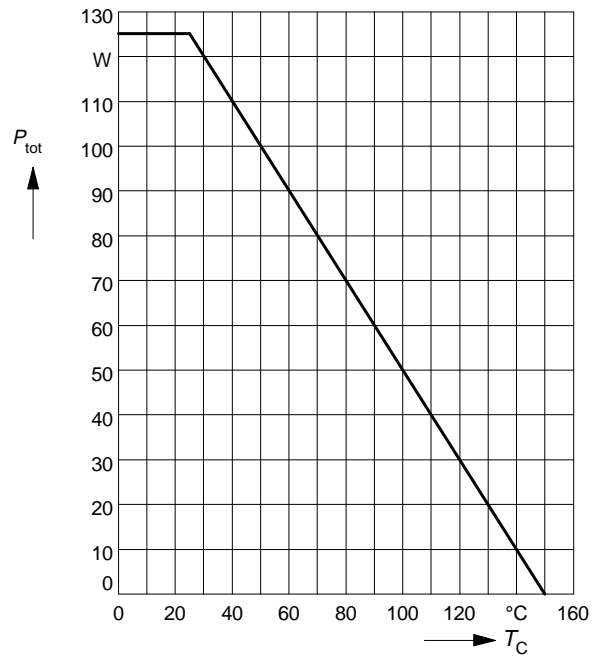

Drain current

$$I_D = f(T_C)$$

parameter: $V_{GS} \geq 10 \text{ V}$

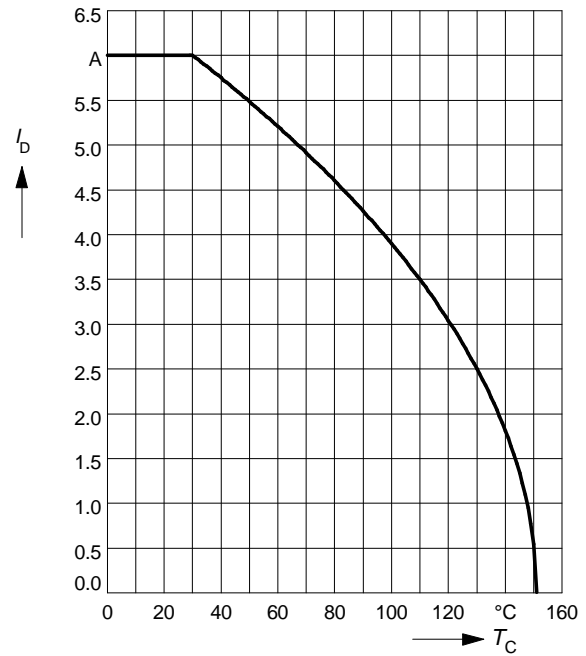

Safe operating area

$$I_D = f(V_{DS})$$

parameter: $D = 0.01$, $T_C = 25^\circ\text{C}$

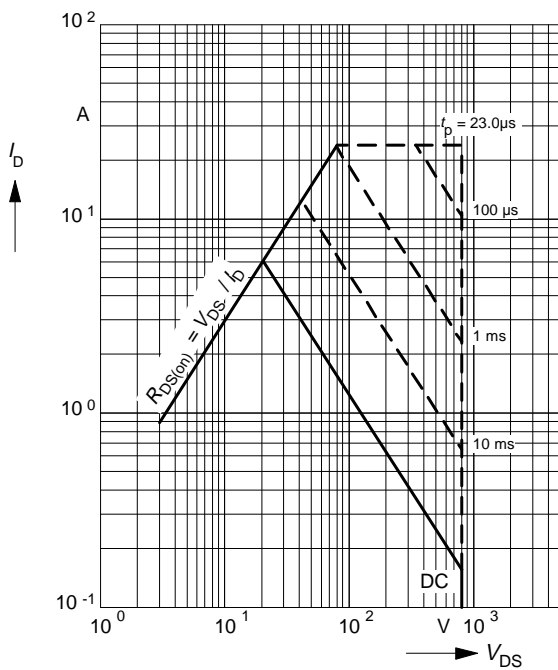

Transient thermal impedance

$$Z_{\text{thJC}} = f(t_p)$$

parameter: $D = t_p / T$

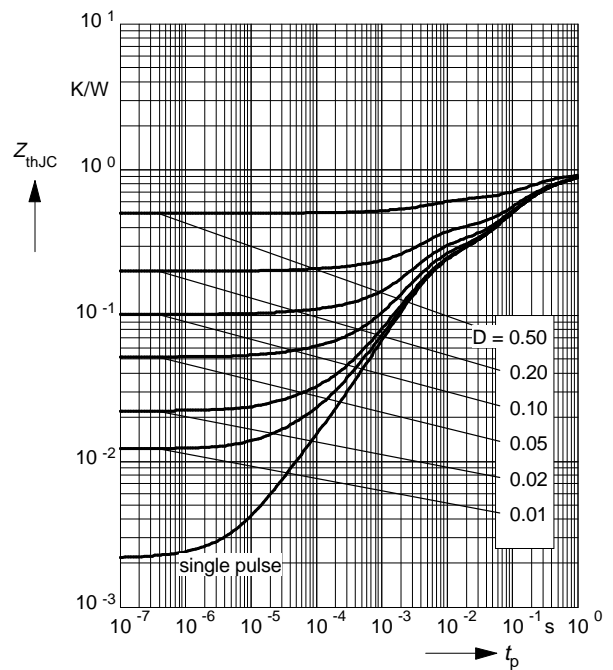

Typ. output characteristics

$I_D = f(V_{DS})$
parameter: $t_p = 80 \mu s$

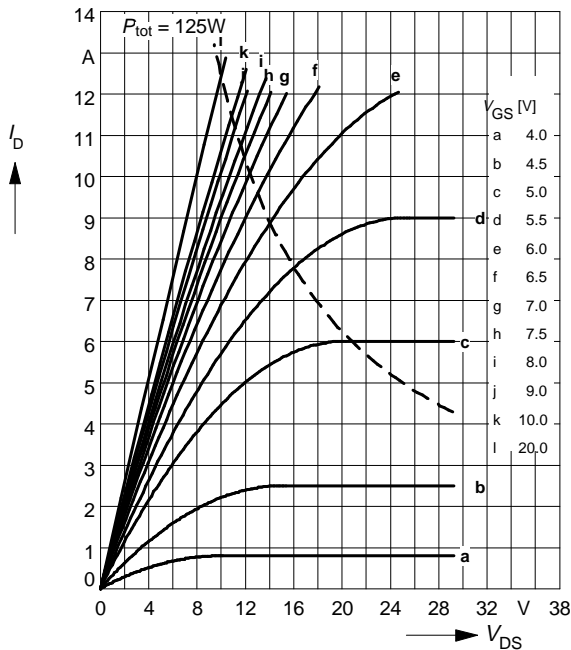

Typ. drain-source on-resistance

$R_{DS(on)} = f(I_D)$
parameter: V_{GS}

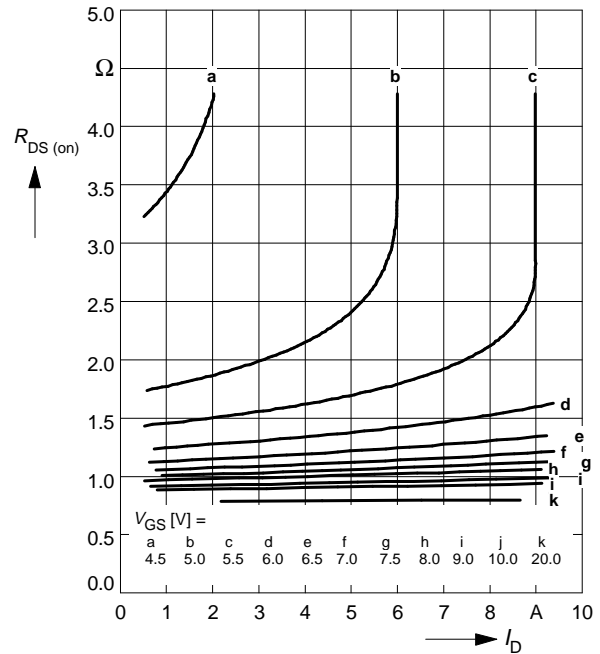

Typ. transfer characteristics $I_D = f(V_{GS})$

parameter: $t_p = 80 \mu s$
 $V_{DS} \geq 2 \times I_D \times R_{DS(on)max}$

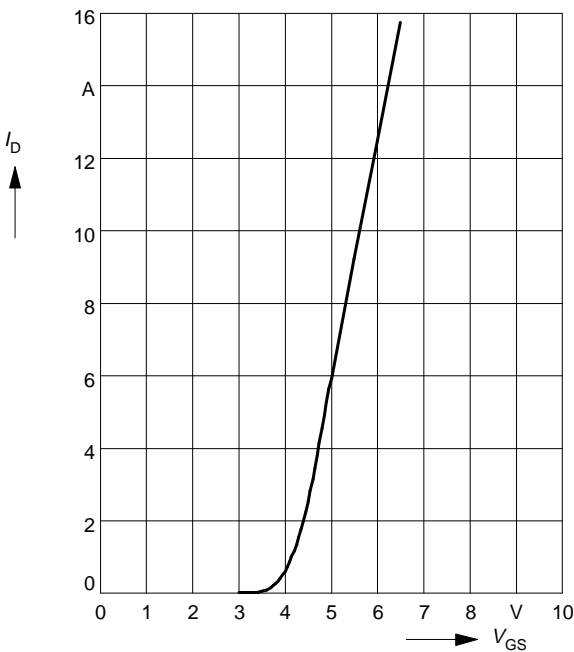

Typ. forward transconductance $g_{fs} = f(I_D)$

parameter: $t_p = 80 \mu s$,
 $V_{DS} \geq 2 \times I_D \times R_{DS(on)max}$

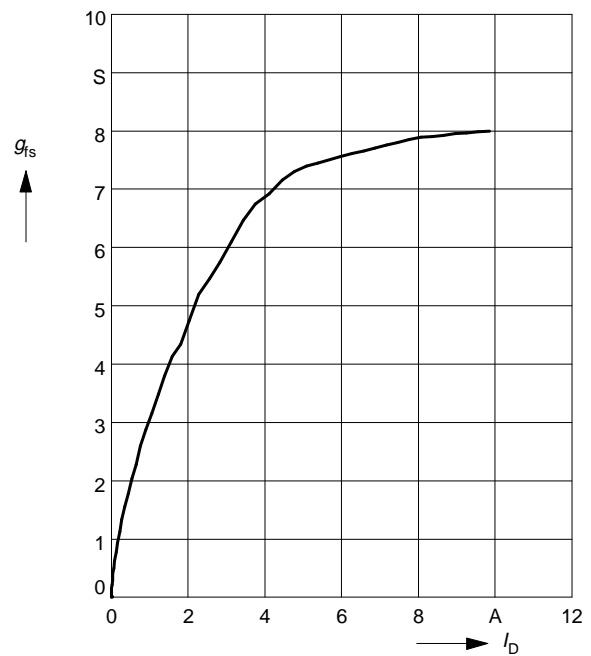

Drain-source on-resistance

$$R_{DS(on)} = f(T_j)$$

parameter: $I_D = 3.9 \text{ A}$, $V_{GS} = 10 \text{ V}$

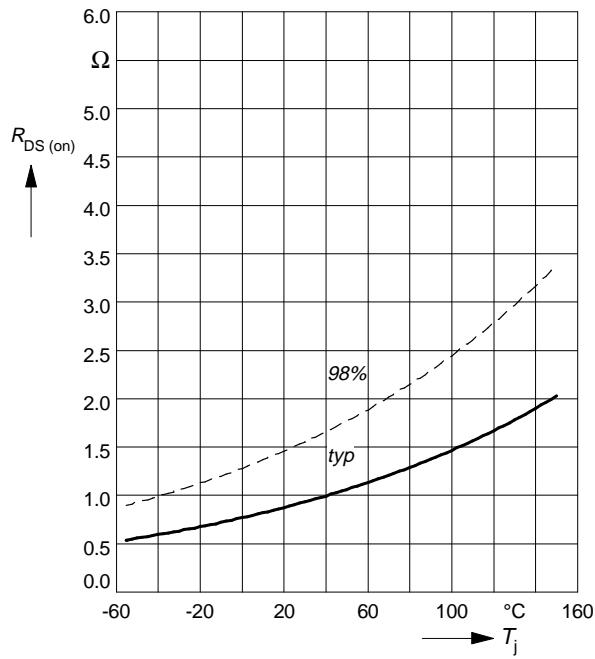

Gate threshold voltage

$$V_{GS(th)} = f(T_j)$$

parameter: $V_{GS} = V_{DS}$, $I_D = 1 \text{ mA}$

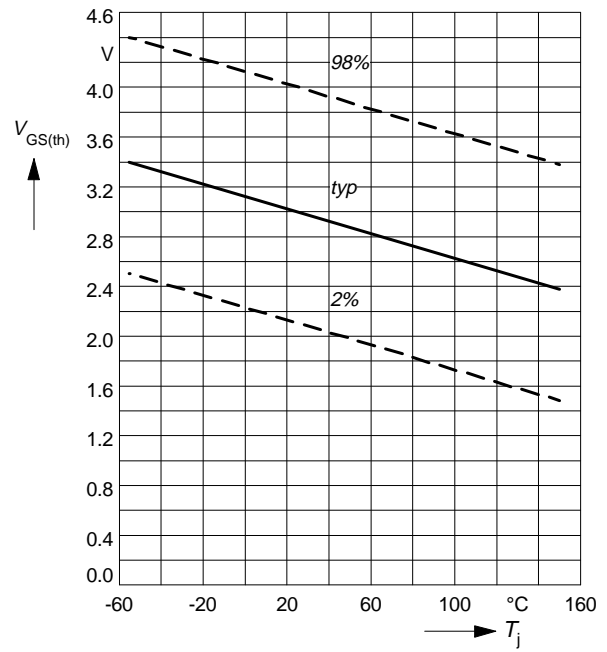

Typ. capacitances

$$C = f(V_{DS})$$

parameter: $V_{GS} = 0 \text{ V}$, $f = 1 \text{ MHz}$

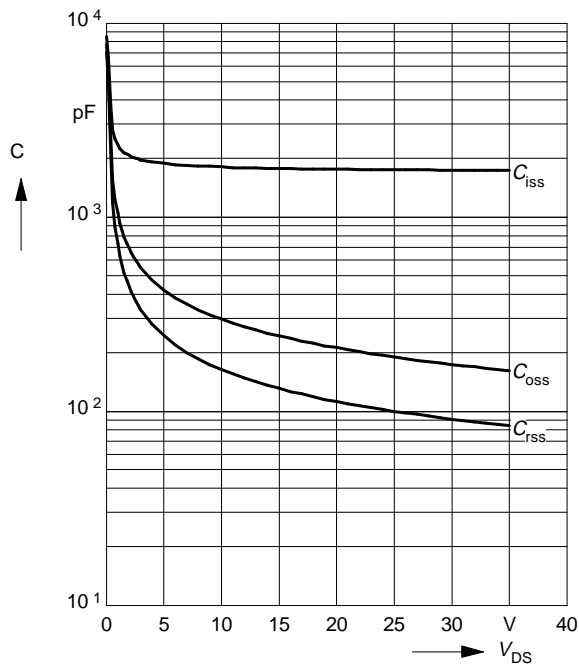

Forward characteristics of reverse diode

$$I_F = f(V_{SD})$$

parameter: T_j , $t_p = 80 \mu\text{s}$

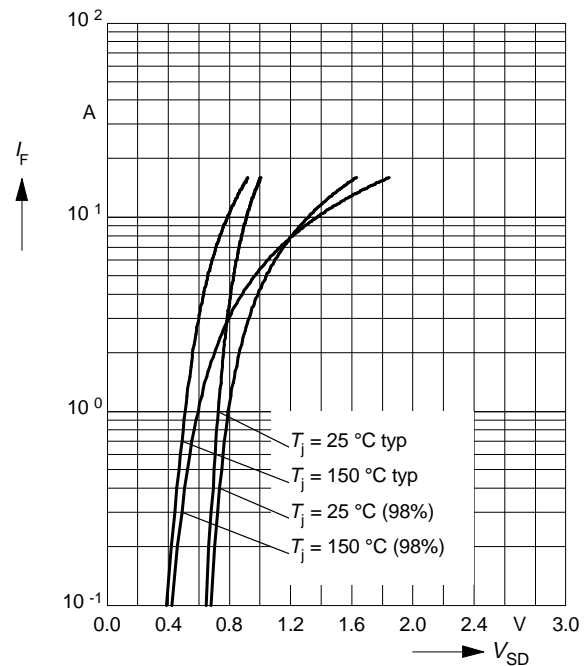

Avalanche energy $E_{AS} = f(T_j)$

parameter: $I_D = 6 \text{ A}$, $V_{DD} = 50 \text{ V}$

$R_{GS} = 25 \Omega$, $L = 37.5 \text{ mH}$

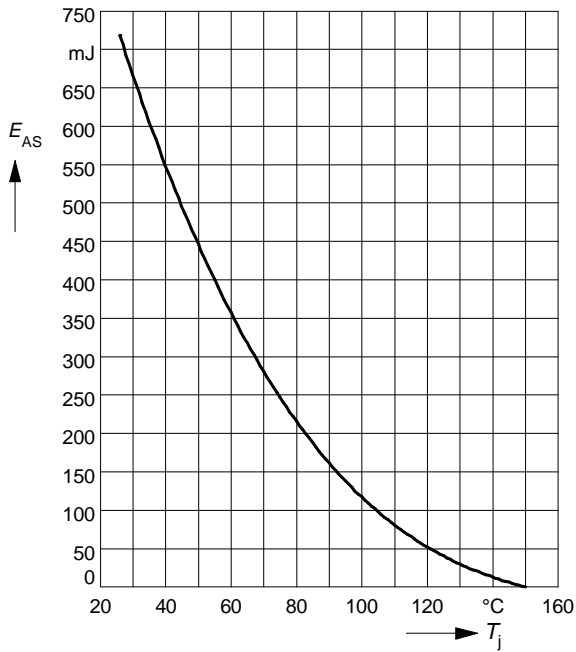

Typ. gate charge $V_{GS} = f(Q_{Gate})$

$V_{GS} = f(Q_{Gate})$

parameter: $I_{D \text{ puls}} = 9 \text{ A}$

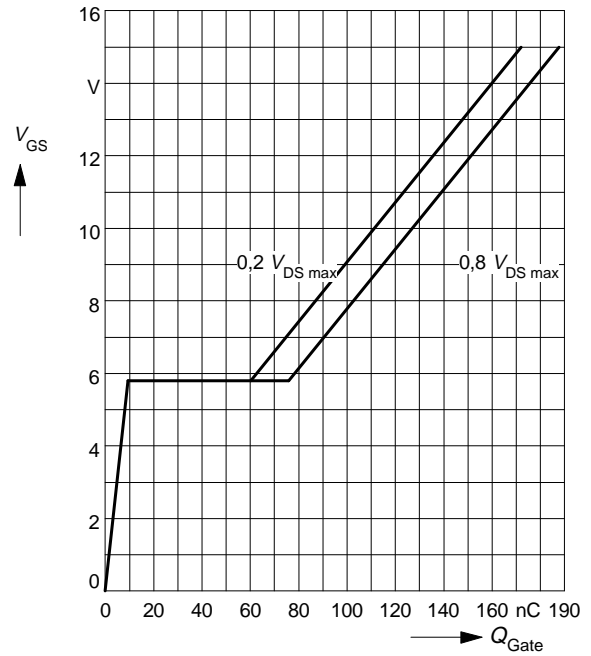

Drain-source breakdown voltage $V_{(BR)DSS} = f(T_j)$

$V_{(BR)DSS} = f(T_j)$

