

3" x 5" x 1.3"

- 130 Watts Output Power
- Single and Triple Outputs
- Universal 90-264VAC Input
- 5VDC to 48VDC Outputs
- 4242VDC Input to Output Isolation
- Active Power Factor Correction



Model Number	Output V	Output I max.	Ripple & Noise	Efficiency(min/nom)	Capacitive Load
SINGLE OUTPUT					
PMK130S-5 (U)(-A)	5 VDC	22 Amps	100mV pk-pk	75% / 80%	10,000uF
PMK130S-12 (U)(-A)	12 VDC	10.8 Amps	120mV pk-pk	80% / 82%	26,800uF
PMK130S-15 (U)(-A)	15 VDC	8.7 Amps	120mV pk-pk	80% / 85%	22,000uF
PMK130S-24 (U)(-A)	24 VDC	5.4 Amps	120mV pk-pk	82% / 85%	28,000uF
PMK130S-28 (U)(-A)	28 VDC	4.6 Amps	120mV pk-pk	82% / 85%	16,800uF
PMK130S-36 (U)(-A)	36 VDC	3.6 Amps	120mV pk-pk	82% / 85%	1,950uF
PMK130S-48 (U)(-A)	48 VDC	2.7 Amps	120mV pk-pk	82% / 85%	7,800uF
TRIPLE OUTPUT					
PMK130T-A (U)(-A)	5/12/12 VDC	15/5/1 Amps	100/120/120mV pk-pk	75% / 80%	25,000uF
PMK130T-B (U)(-A)	5/15/15 VDC	15/5/1 Amps	100/150/150mV pk-pk	75% / 80%	25,000uF
PMK130T-C (U)(-A)	5/24/12 VDC	4/4/2 Amps	100/240/120mV pk-pk	75% / 80%	25,000uF
PMK130T-D (U)(-A)	12/24/5 VDC	8/2/3 Amps	12/240/1000mV pk-pk	75% / 80%	15,000uF

Note:

- The PMK130 Series is offered in an optional U-Channel Chassis as well as with optional 3.96mm pitch 5 and 10 Pin Input and Output connectors (open frame construction and screw terminals are standard respectively). Simply add a "U" at the end of the Model Number to receive the U-Channel configuration or a "-A" to receive the pins, or both if both are desired. For example: The Model Number "PMK130T-AU-A" represents a triple output (5/12/12VDC) U-Channel supply with 3.96 pitched pins (5 Input; 10 Output) . See the Mechanical Dimensions on pages 3 through 14 in this specification
- PMK130T-A and all "U" options are not covered by UL Certification unless provided with more than 10 CFM forced air cooling applied 6-10cm above T1.
- Derating curves acceptable up to 40°C for UL certified products

All specifications are typical at nominal input, full load, and 25°C unless otherwise noted

* These are stress ratings. Exposure of the devices to any of these conditions may adversely affect long term reliability. Proper operation under conditions other than the standard operating conditions is neither warranted nor implied.

Astrodyne products are not authorized or warranted for use as critical components in life support systems, equipment used in hazardous environments, nuclear controls systems, or other mission-critical applications.

INPUT SPECIFICATIONS

Input Voltage Range	90-264VAC
Frequency Range	47 - 63 Hz
Inrush Current, typ:	60A @ 230VAC Input *
Input Current	2.3~0.8A (90-264VAC)
Power Factor (cold start)	PF > 0.96 @ 230VAC
Leakage Current	<3.5mA @ 264VAC, 50Hz

OUTPUT SPECIFICATIONS

Voltage and Current	See Selection Chart
Minimum Load (Triples)	0.1A /0.1A/ 0A (0A Singles)
Maximum Output Power	130 Watts
Preset Accuracy (Note 7)	1%
Line Regulation (Note 6)	0.5% nom / 1% max
Load Regulation (Note 5)	0.5% nom / 1% max Singles 2%/5%/5% max. Triples
Ripple/Noise (Notes 1,2,8)	See Selection Chart
Turn On	<4S, typ.
Hold Up Time	20mS, typ.
Rise Time	30mS, typ.
Short Circuit Protection	Auto recovery *
Over Voltage Protection	130% max., Auto recovery *
Over Current Protection	150% max., Auto recovery *
Transient Response	10mS
Over Shoot/Under Shoot	<10% of Nominal O/P VDC

GENERAL SPECIFICATIONS

Safety	UL/cUL60950-1, TUV: EN60950-1 CE: EN60601-1, EN60601-1:2001 CB: IEC60950-1
Classification:	Class 1, 3-Pin (L, N FG)
Isolation (Note 3)	4242VDC I/P - O/P * 2828 VDC I/P - GND * 707VDC O/P - GND *
Insulation Resistance	≥ 20MΩ (500VDC, 1S I/P-O/P)
EMI	CISPR EN55022 class B
Efficiency	See Selection Chart

ENVIRONMENTAL SPECIFICATIONS

Oper. Temperature (Note 4)	-10°C to +70°C (See Derate Curve)
Storage Temperature	-25°C to +85°C

Relative Humidity	10 to +90%, non-cond *
EMS Harmonics:	IEC61000-3-2 Class D
Fluctuations:	IEC61000-3-3
ESD:	IEC61000-4-2, 6KV Contact, 8KV Air
RS:	IEC61000-4-3 FR: 80MHz-2.5GHz Field Strength: 3V/M
EFT:	IEC61000-4-4 2KV on AC Line
Surge:	IEC61000-4-5 1KV (L-L); 2KV (L, N-PE)
CS:	IEC61000-4-6 3V (EMF)
Dips:	IEC61000-4-11 95% 250CY, 70% 25CY, 40% 5CY, 5% 0.5CY
MTBF	197,000 Hrs Singles 175,700 Triples to MIL-HDBK-217F
Vibration	4G Peak, 50~500Hz, 3 Axes, 30 min*
Drop Test	Test Height 70cm *

PHYSICAL SPECIFICATIONS

Size (Open Frame)	76.2 x 127 x 30.48mm (3" x 5" x 1.2")
(U-Channel)	115.6 x 80.5 x 28mm (4.55" x 3.17" x 1.50")
Weight Open-Frame	10.25 oz (291g)
U-Bracket	13.38 oz (380g)

NOTES:

1. All measurements should be made directly at the terminals of the power supply.
2. Ripple and Noise depend upon output voltage a specified per particular model.
3. Isolation for up to 1min duration.
4. Specified for free-air convection cooling.
5. Load regulation measured from 20% to full load.
6. Line regulation measured from 90 - 264VAC/100VAC minimum required for full load start.
7. Preset accuracy measured at nominal load, 120VAC input.
8. O/P oise measured directly at pins/terminals @ nominal load, 0uF by pass and 47uF electrolytic, pk-pk@ 20MHz bandwidth.

Special EMC Notice: The end application shall provide an earth ground connection for conducted & radiated emission performance. Astrodyne is not liable for the end application without extra earth connection to PMK130S Open Frame Power Supply.

MECHANICAL DIMENSIONS

Open-Frame (PMK130S-xx) :

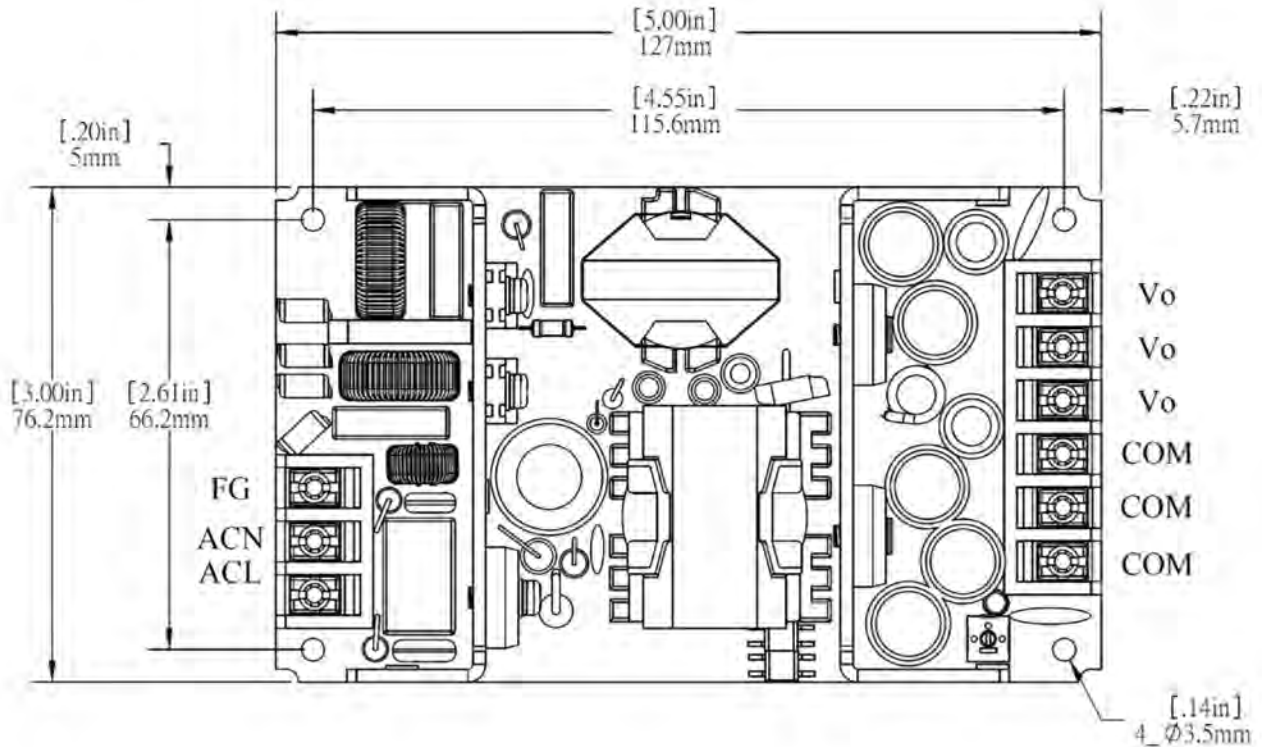

Input connector : 3P / 8.25mm pitch TERMINAL BLOCK
 Output connector : 6P / 8.25 mm pitch TERMINAL BLOCK

MECHANICAL DIMENSIONS

U-Bracket (PMK130S-xxU) :

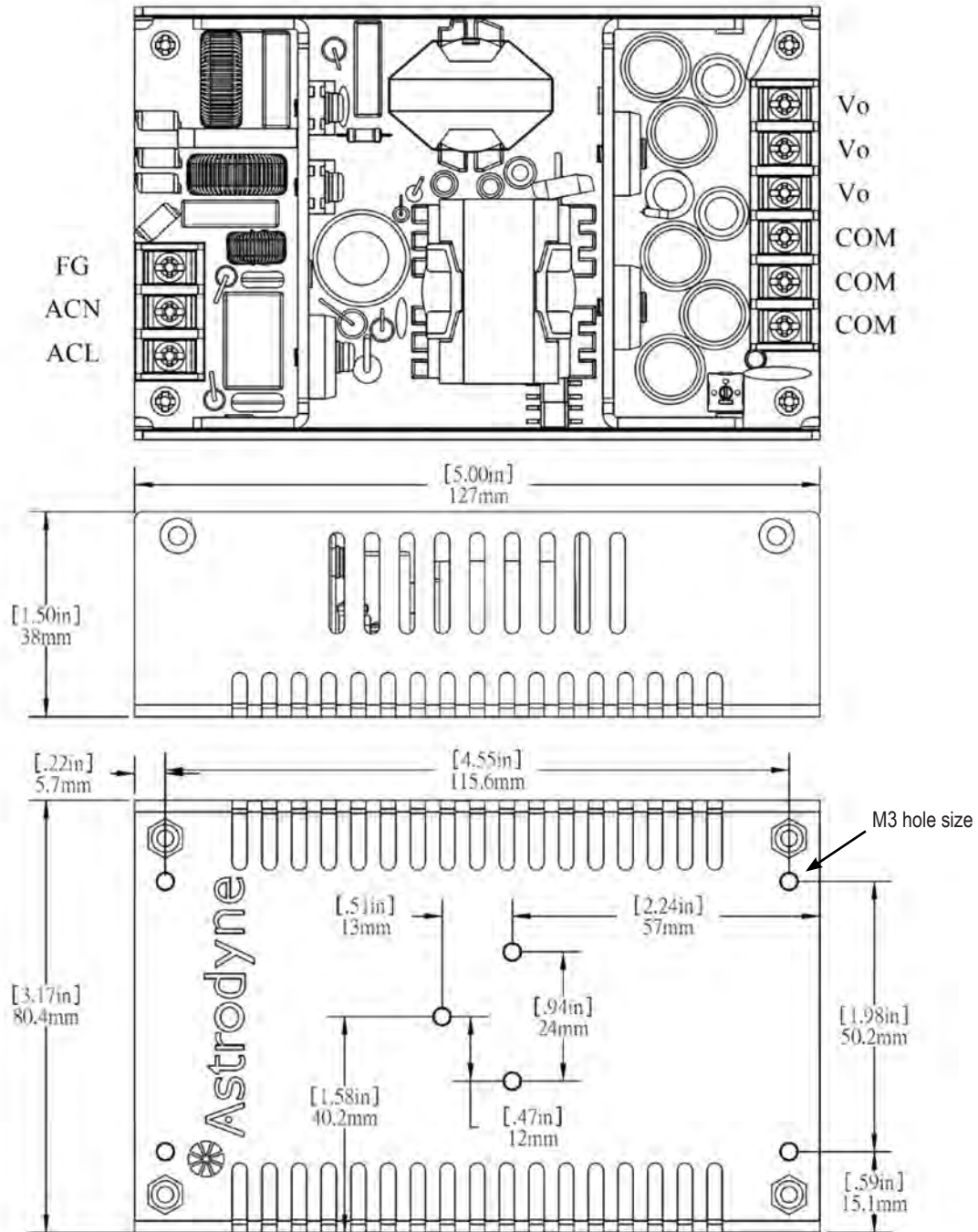

Input connector : 3P / 8.25mm pitch TERMINAL BLOCK

Output connector : 6P / 8.25 mm pitch TERMINAL BLOCK

MECHANICAL DIMENSIONS - FAN PLACEMENT RECOMMENDATION

Open-Frame (PMK130S-xx) :

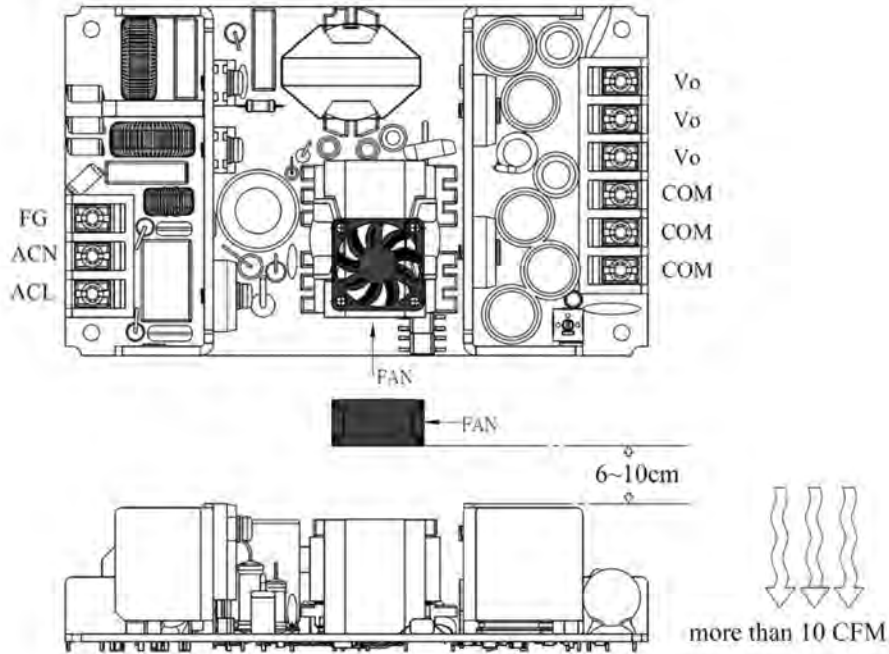

U-Bracket (PMK130S-xxU) :

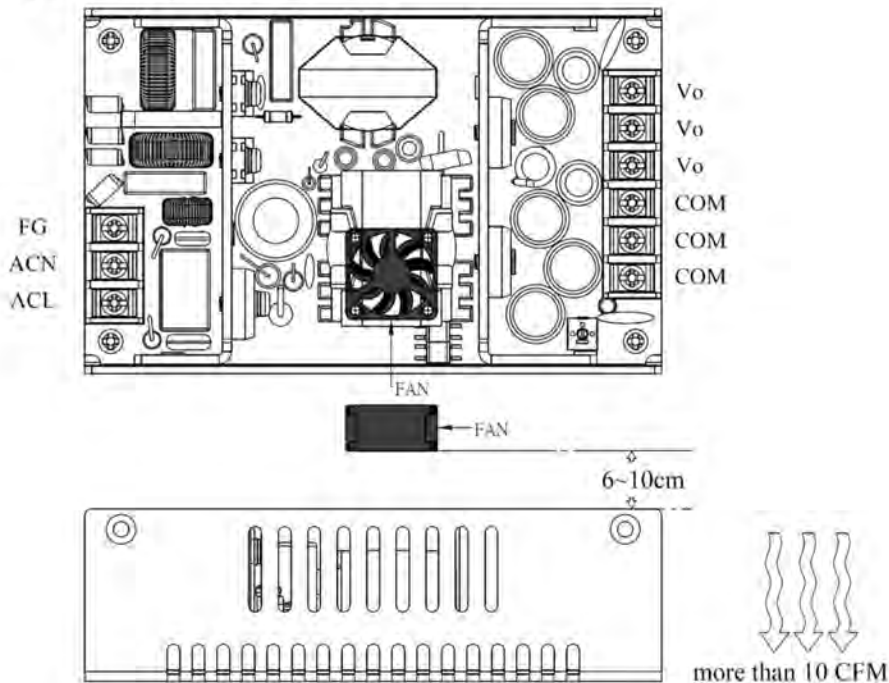

MECHANICAL DIMENSIONS

Open-Frame (PMK130S-xx-A) :

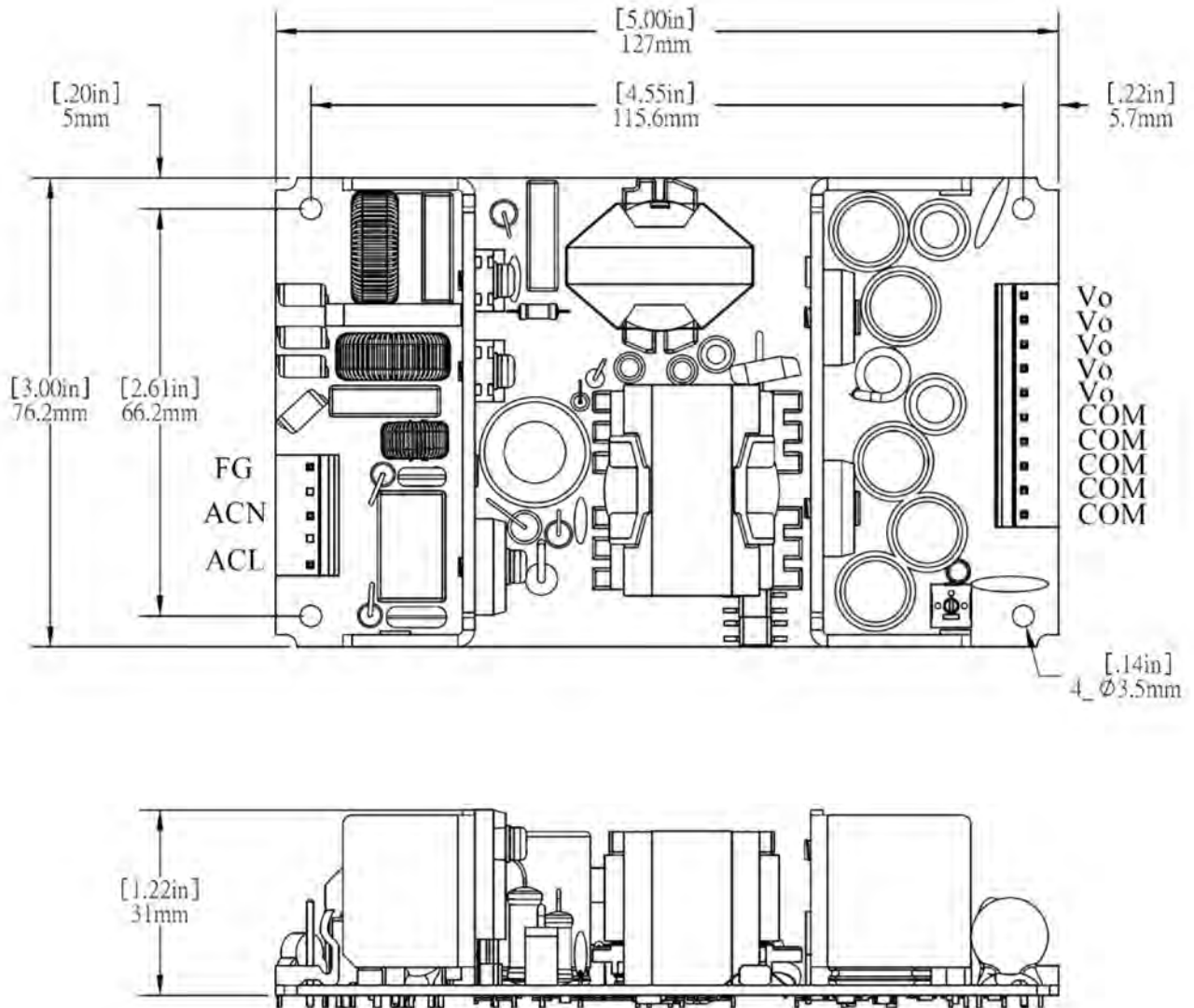

Input connector : 5P / 3.96mm pitch MOLEX 41791-0005
 Output connector : 10P / 3.96 mm pitch MOLEX 41791-0010

MECHANICAL DIMENSIONS

U-Bracket (PMK130S-xxU-A) :

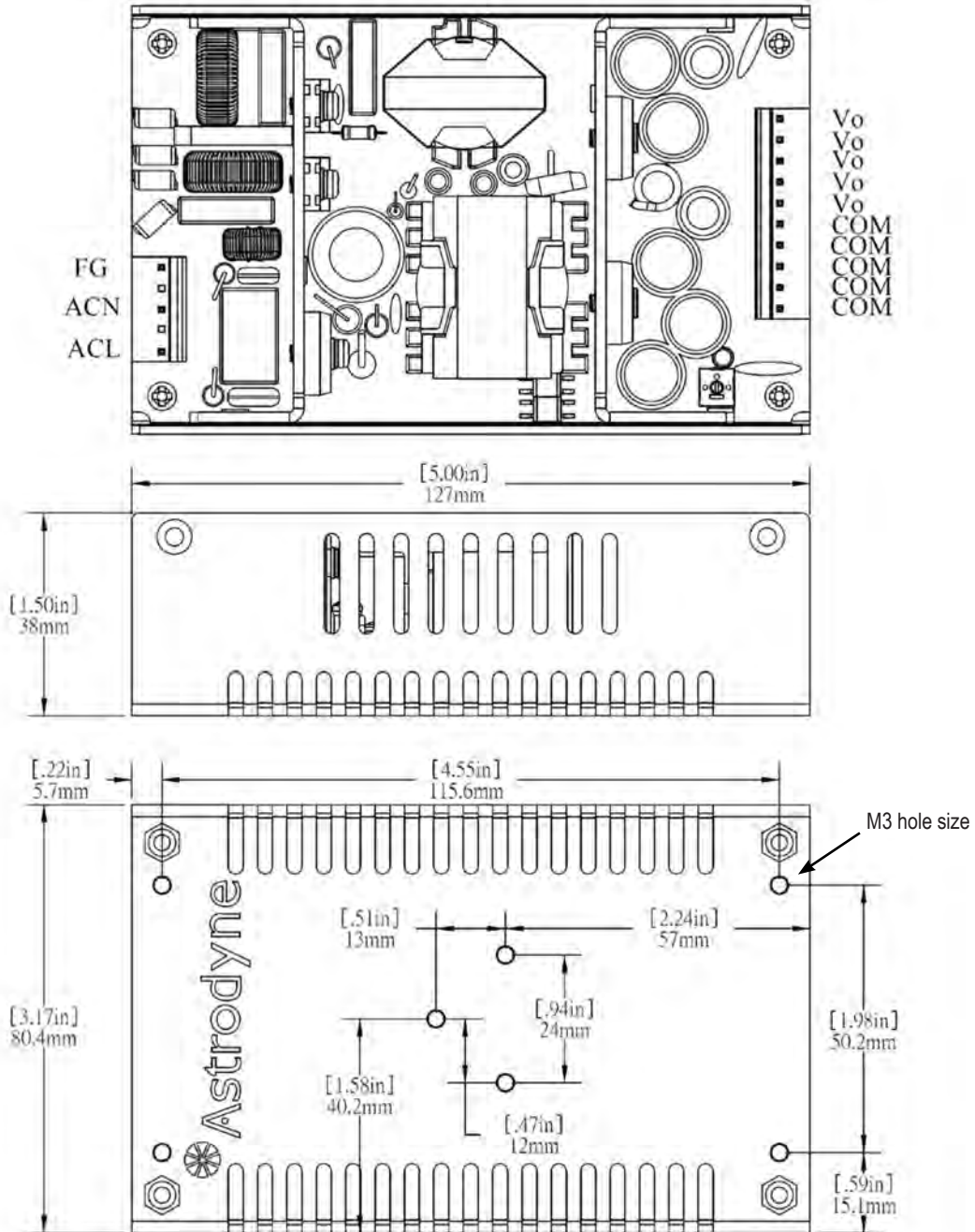

Input connector : 5P / 3.96mm pitch MOLEX 41791-0005
 Output connector : 10P / 3.96 mm pitch MOLEX 41791-0010

MECHANICAL DIMENSIONS - FAN PLACEMENT RECOMMENDATION

Open-Frame (PMK130S-xx-A) :

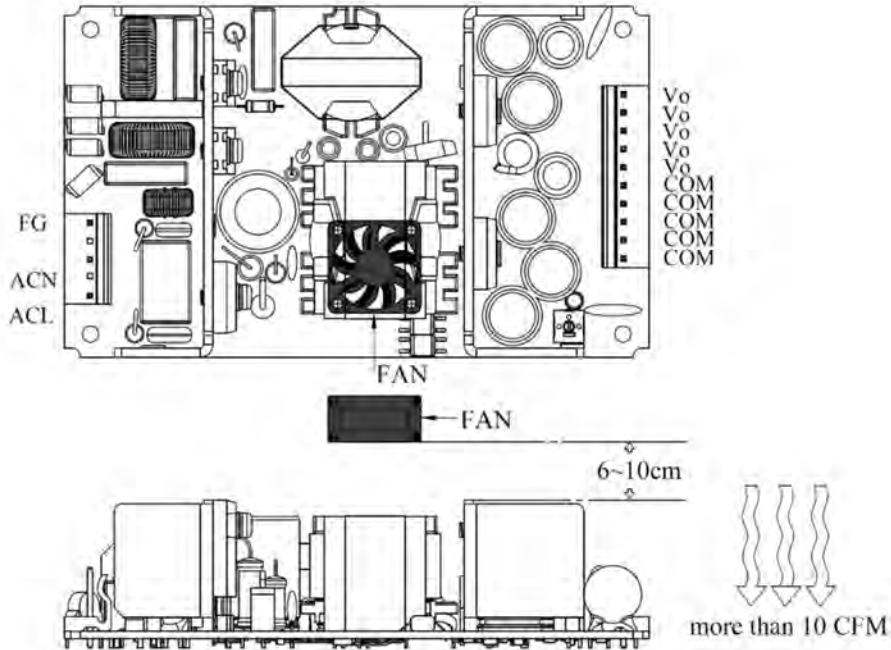

U-Bracket (PMK130S-xxU-A) :

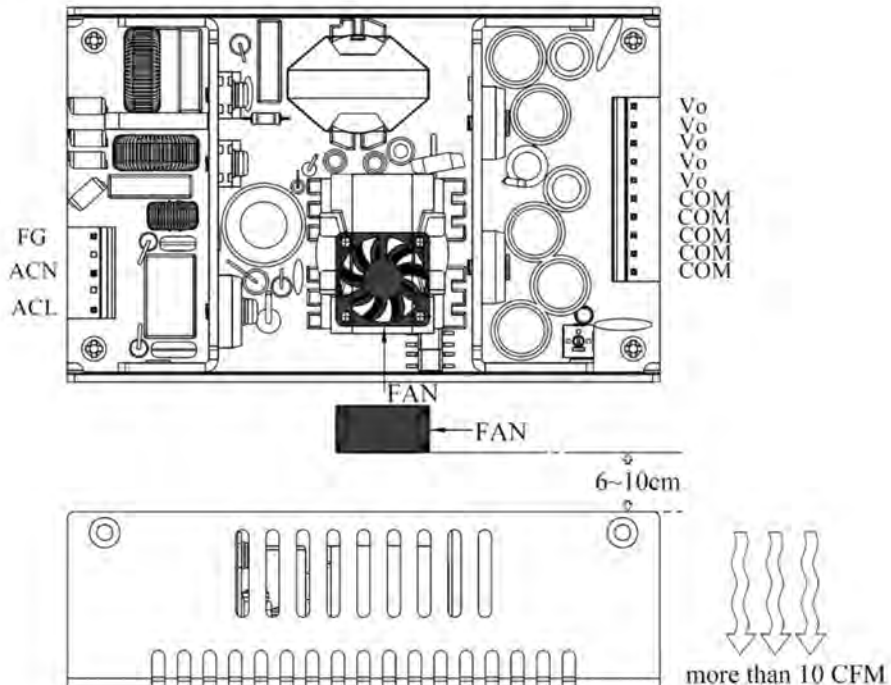

MECHANICAL DIMENSIONS

Open-Frame (PMK130T-xx) :

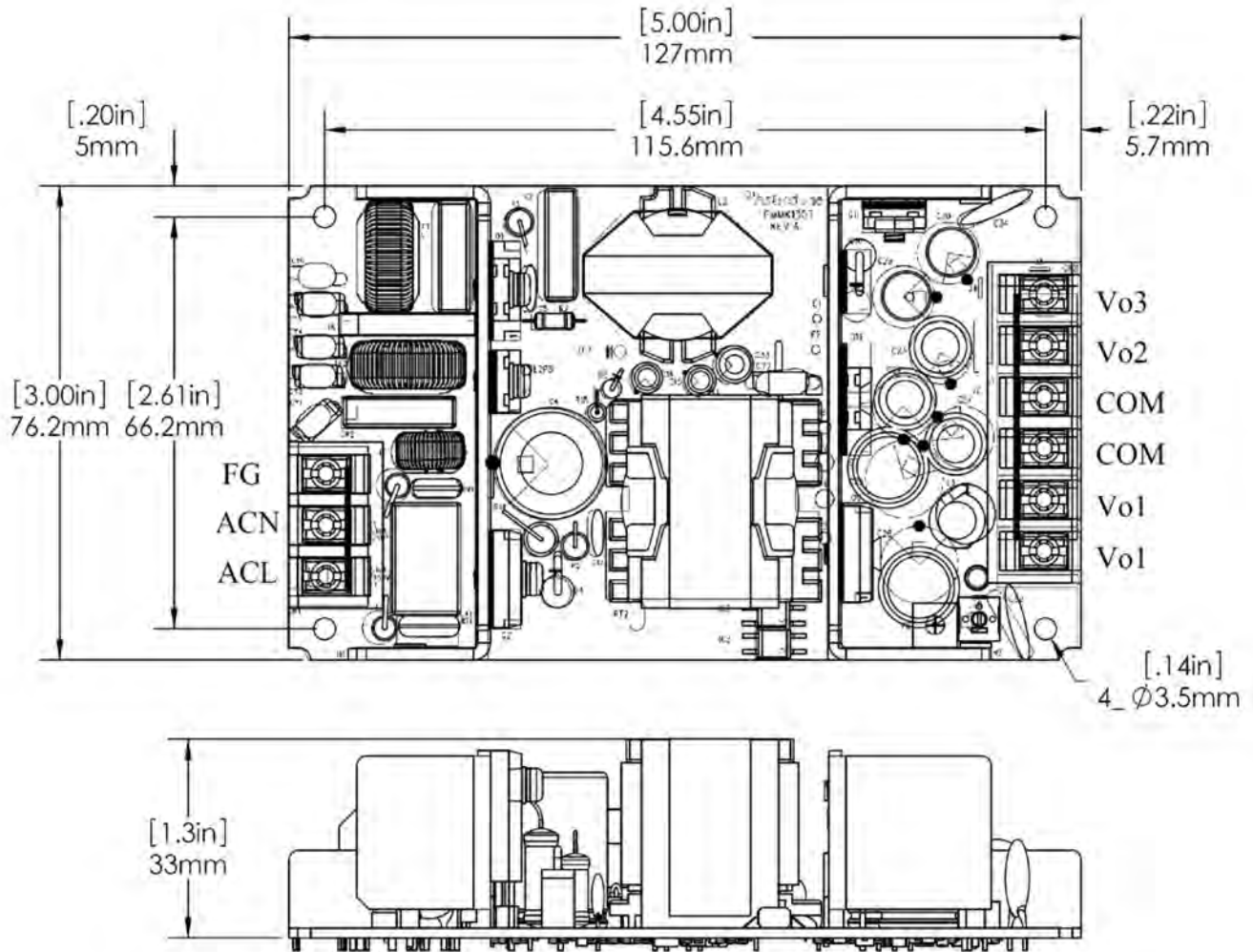

Output Model	Vo1	Vo2	Vo3
A	+5V	+12V	-12V
B	+5V	+15V	-15V
C	+5V	+24V	+12V
D	+12V	+24V	+5V

Input connector : 3P / 8.25mm pitch TERMINAL BLOCK

Output connector : 6P / 8.25mm pitch TERMINAL BLOCK

MECHANICAL DIMENSIONS

U-Bracket (PMK130T-xxU) :

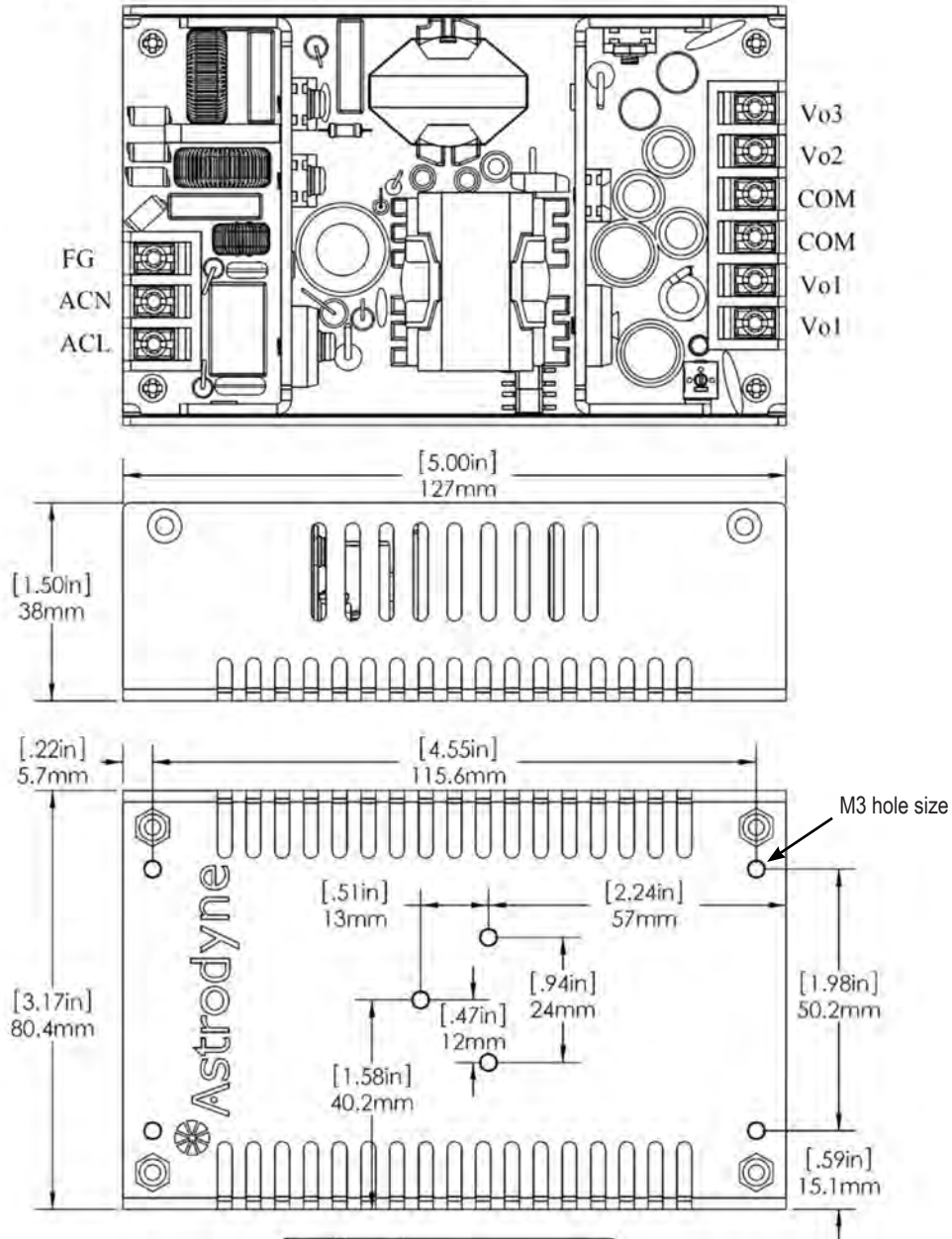

Output Model	Vo1	Vo2	Vo3
A	+5V	+12V	-12V
B	+5V	+15V	-15V
C	+5V	+24V	+12V
D	+12V	+24V	+5V

Input connector : 3P / 8.25mm pitch TERMINAL BLOCK

Output connector : 6P / 8.25mm pitch TERMINAL BLOCK

MECHANICAL DIMENSIONS - FAN PLACEMENT RECOMMENDATION

Open-Frame (PMK130T-xx) :

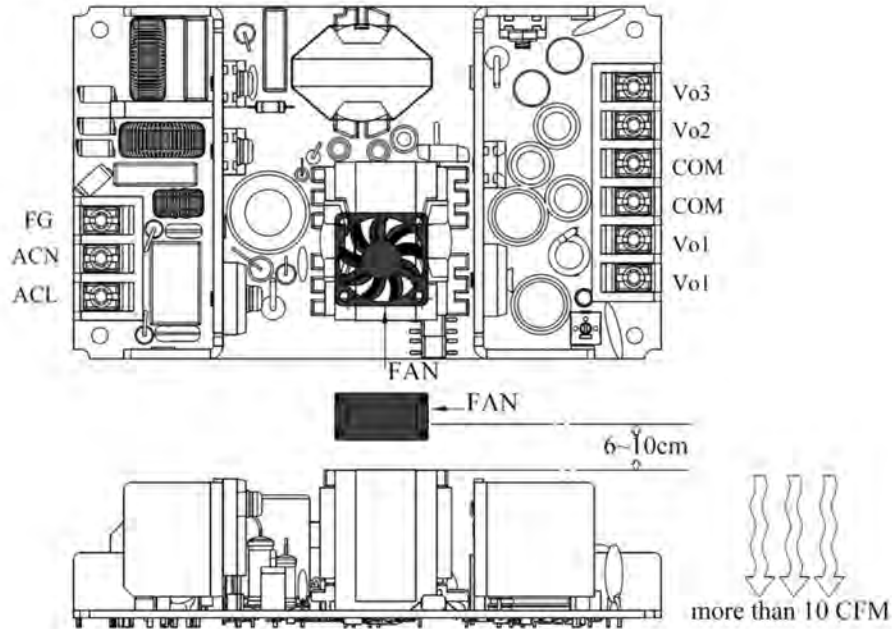

U-Bracket (PMK130T-xxU) :

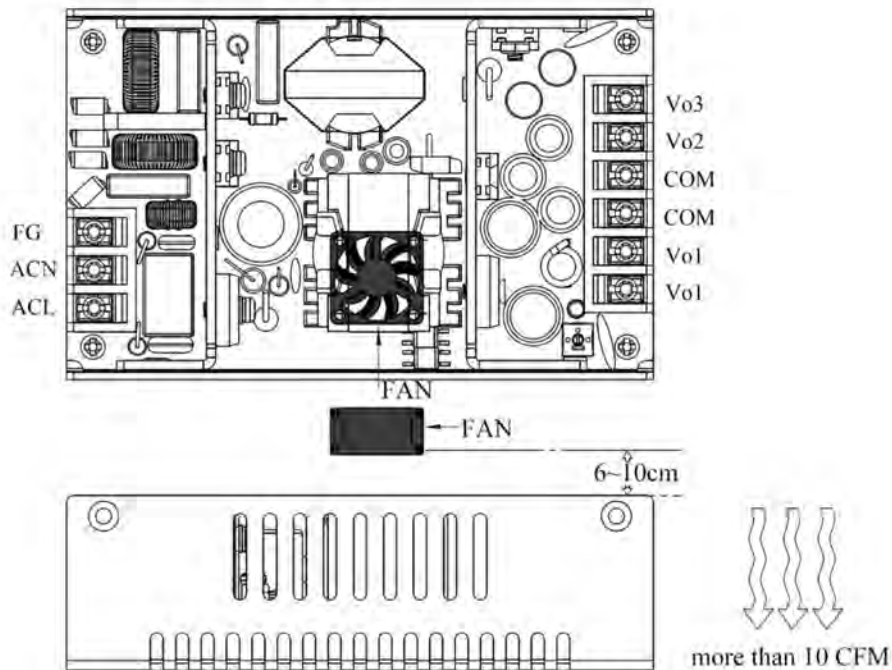

MECHANICAL DIMENSIONS

Open-Frame (PMK130T-xx-A) :

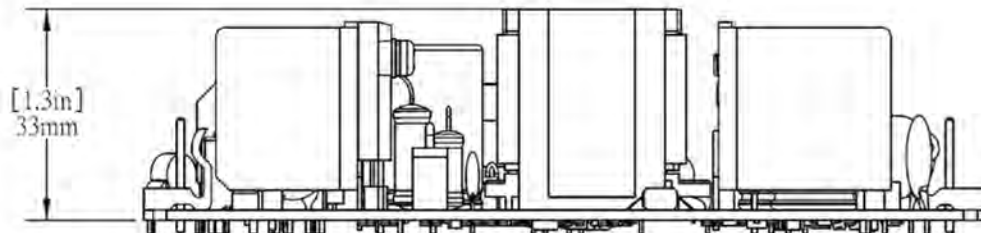
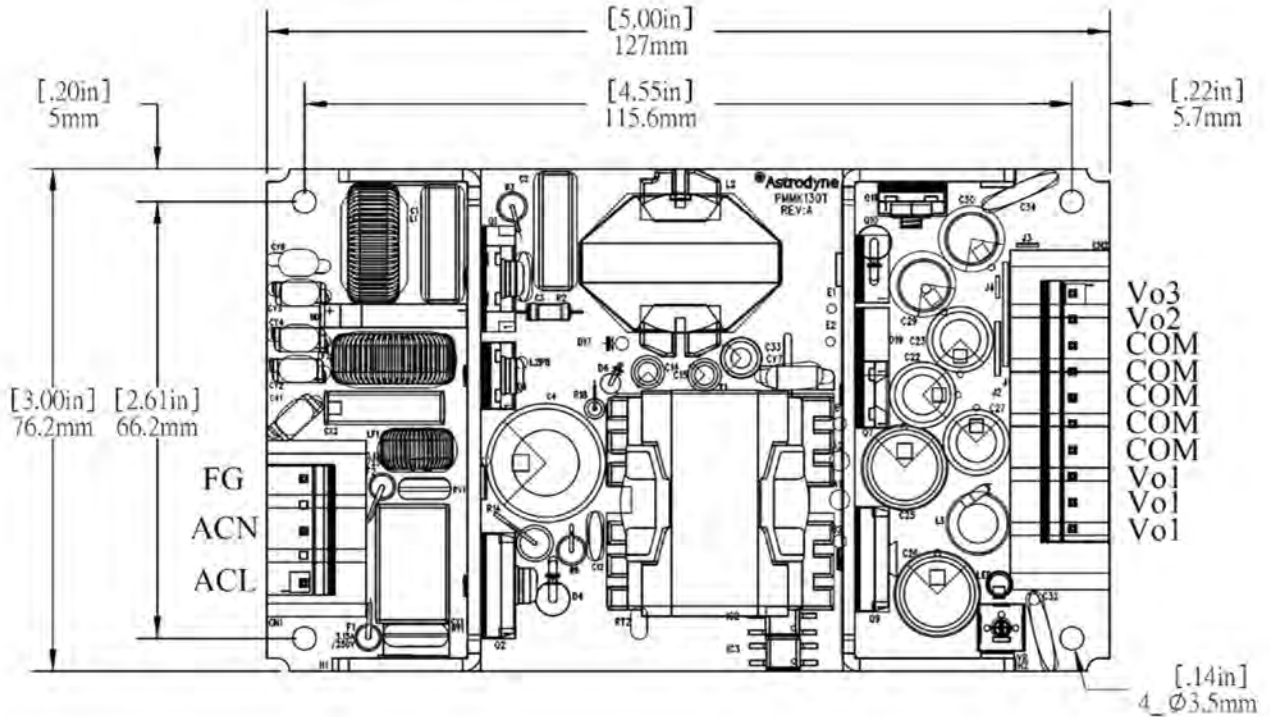

Output Model	Vo1	Vo2	Vo3
A	+5V	+12V	-12V
B	+5V	+15V	-15V
C	+5V	+24V	+12V
D	+12V	+24V	+5V

Input connector : 5P / 3.96mm pitch MOLEX 41791-0005

Output connector : 10P / 3.96 mm pitch MOLEX 41791-0010

MECHANICAL DIMENSIONS

U-Bracket (PMK130T-xxU-A) :

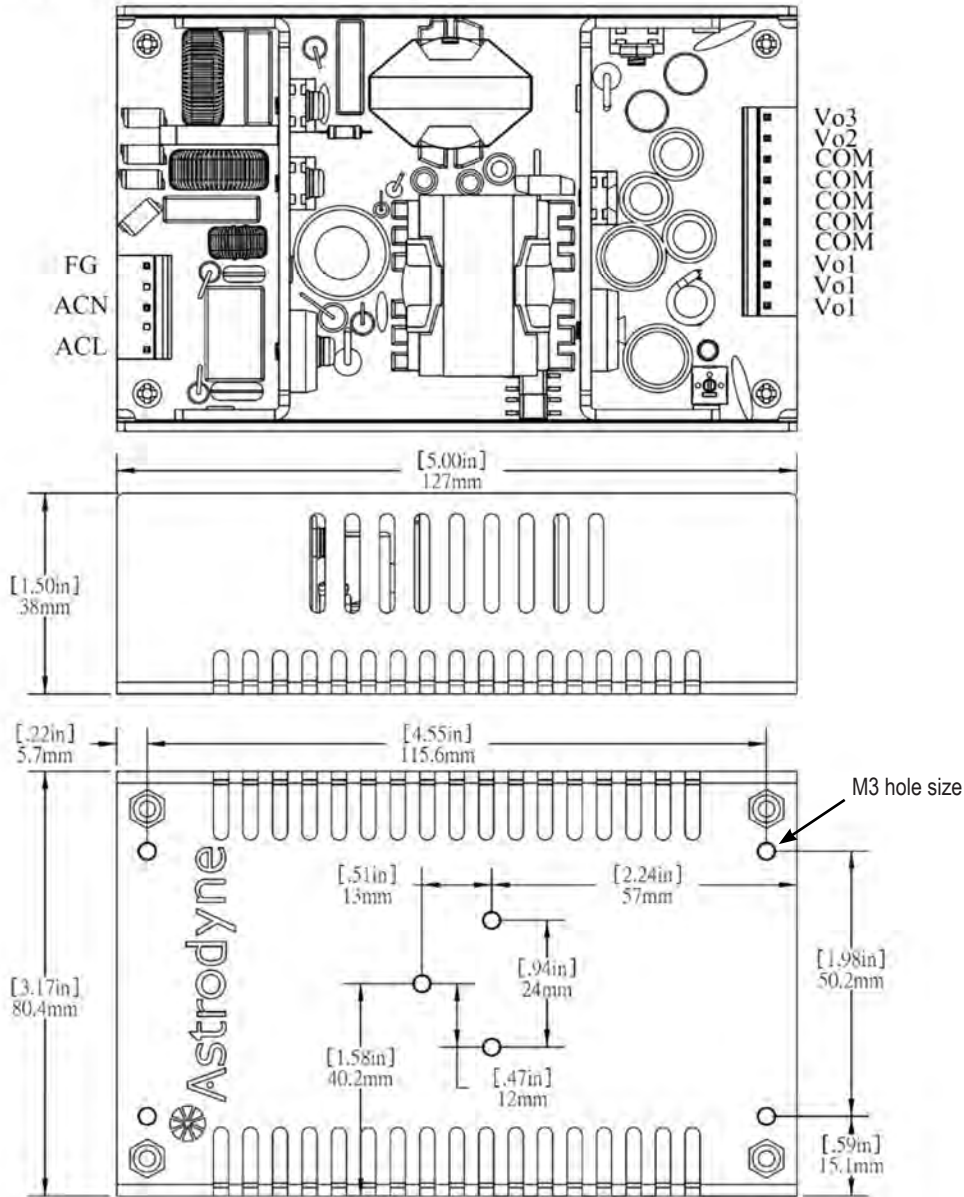

Output Model	Vo1	Vo2	Vo3
A	+5V	+12V	-12V
B	+5V	+15V	-15V
C	+5V	+24V	+12V
D	+12V	+24V	+5V

Input connector : 5P / 3.96mm pitch MOLEX 41791-0005
 Output connector : 10P / 3.96 mm pitch MOLEX 41791-0010

MECHANICAL DIMENSIONS - FAN PLACEMENT RECOMMENDATION

Open-Frame (PMK130T-xx-A) :

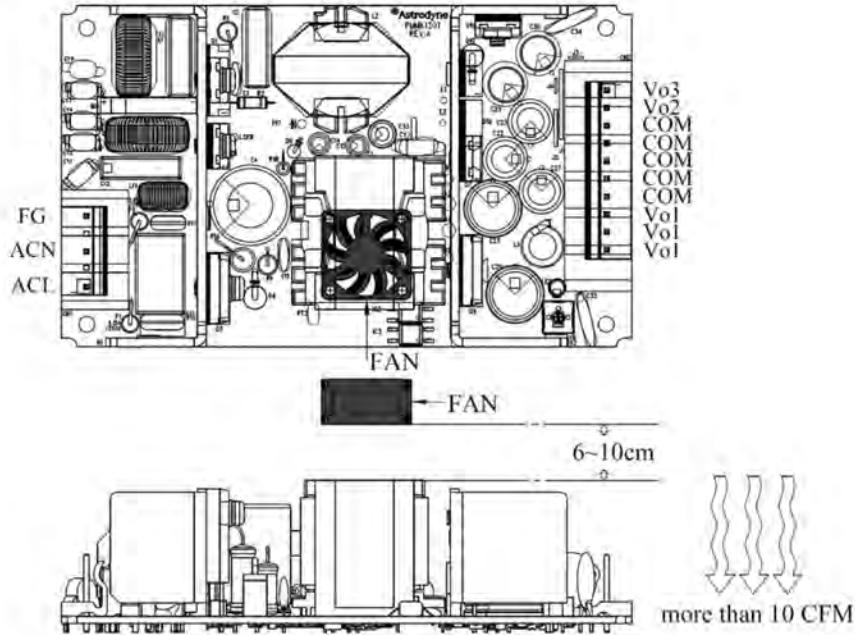

U-Bracket (PMK130T-xxU-A) :

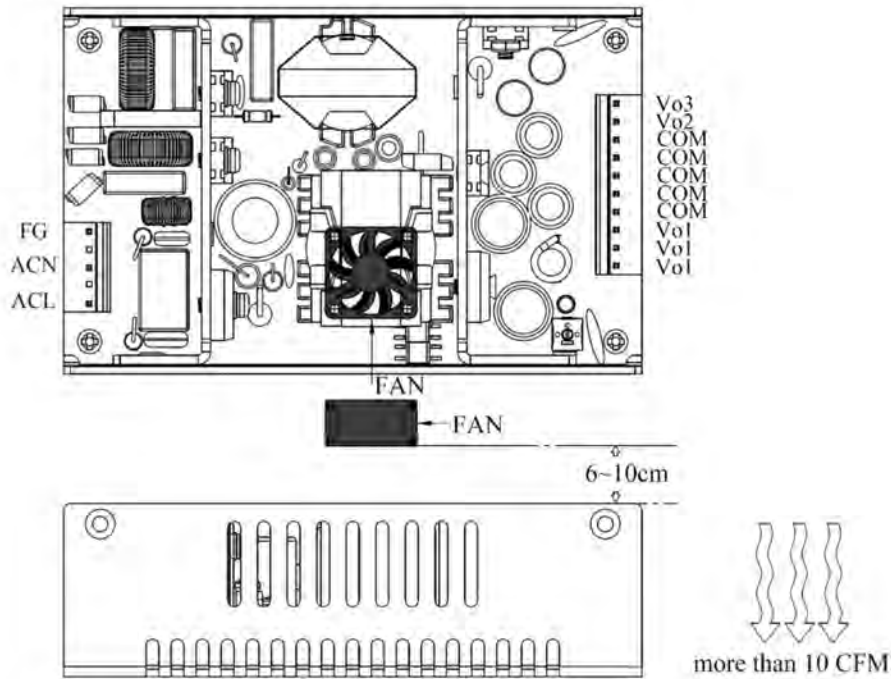

DERATE CURVES

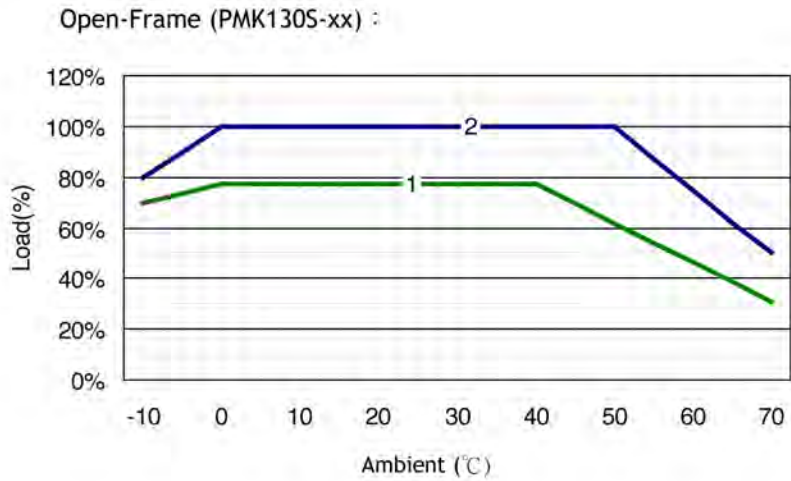

1. Convection
2. Forced air cooling 10CFM

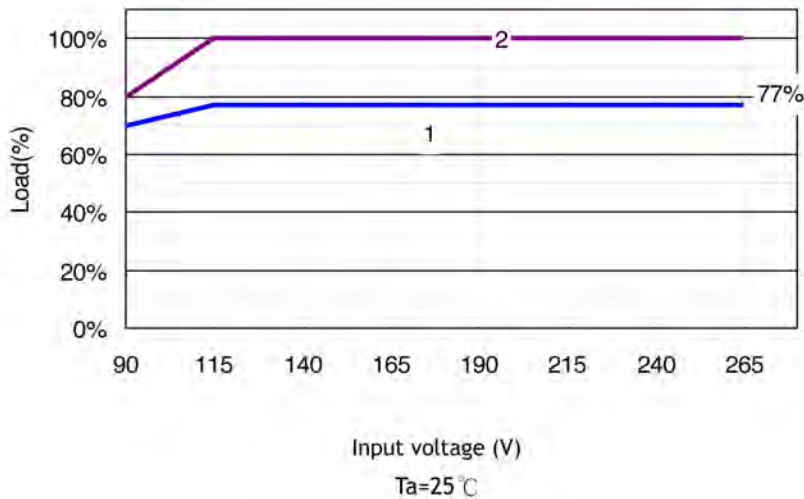

1. Convection
2. Forced air cooling 10CFM

DERATE CURVES

U-Bracket (PMK130S-xxU) :

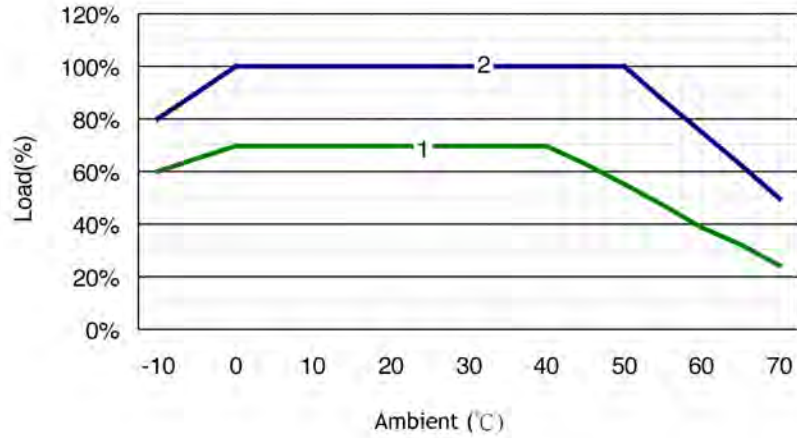

1. Convection
2. Forced air cooling 10CFM

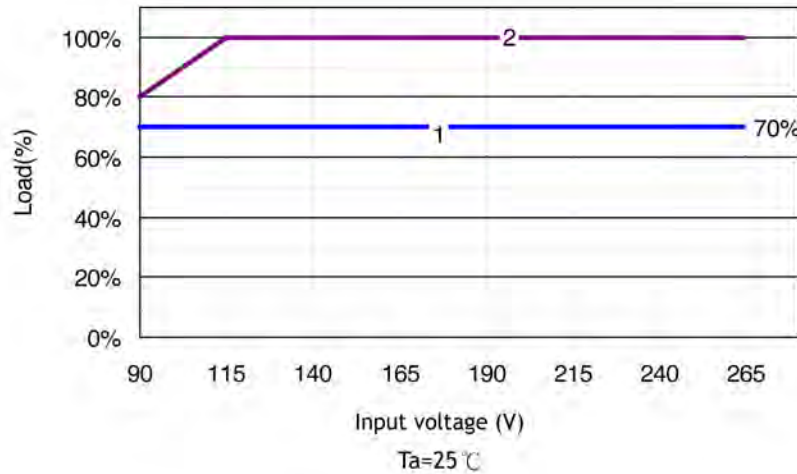

1. Convection
2. Forced air cooling 10CFM

DERATE CURVES

Open-Frame (PMK130T-xx) :

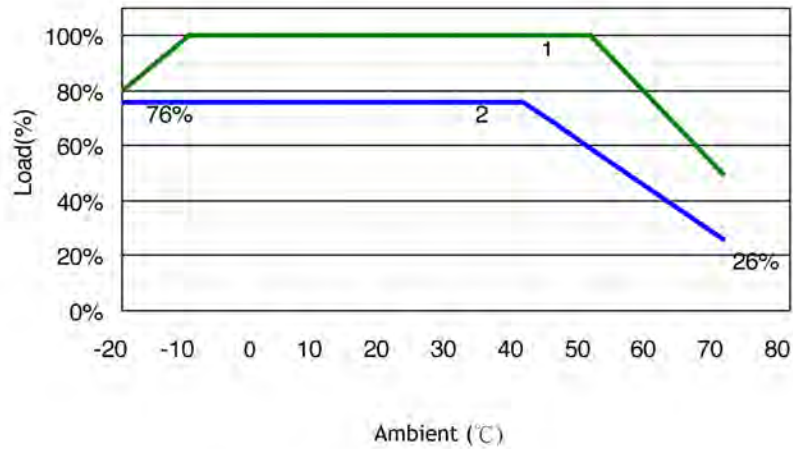

1. Forced air cooling 10CFM
2. Convection

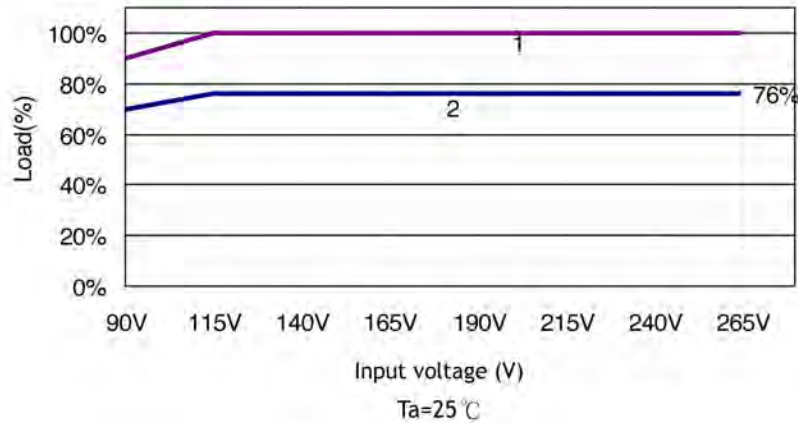

1. Forced air cooling 10CFM
2. Convection

DERATE CURVES

U-Bracket (PMK130T-xxU) :

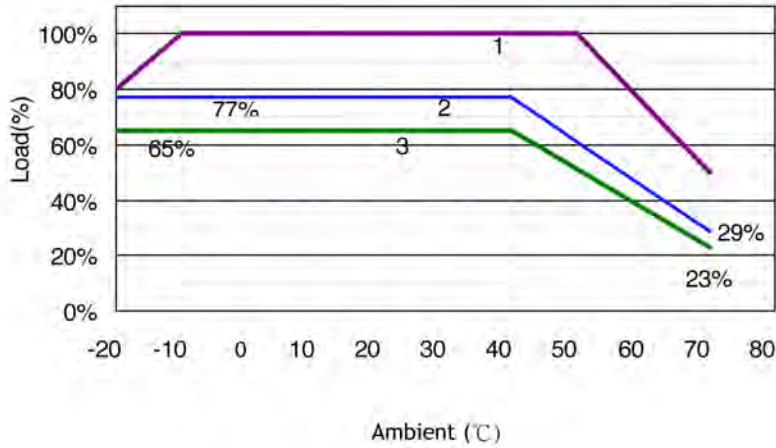

1. Forced air cooling 10CFM
2. C · D convection
3. A · B convection

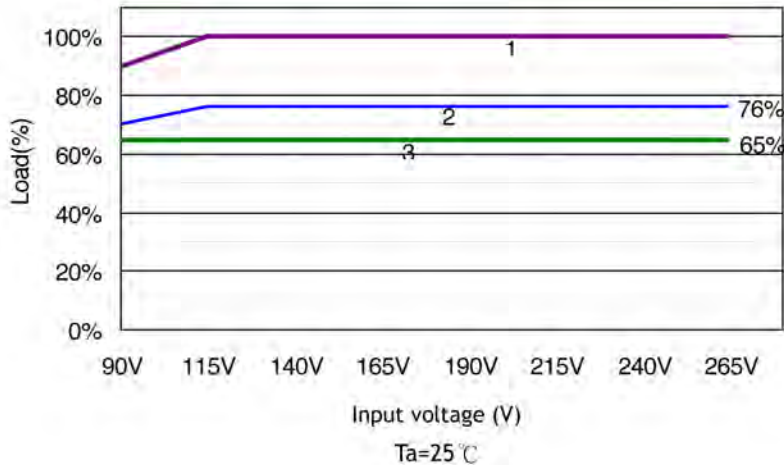

1. Forced air cooling 10CFM
2. C · D convection
3. A · B convection