

This document was generated on 03/22/2010

**PLEASE CHECK WWW.MOLEX.COM FOR LATEST PART INFORMATION**

**Part Number:** **0026481043**  
**Status:** **Active**  
**Description:** 3.96mm (.156") Pitch KK® Header, Breakaway, Vertical, Polarizing Wall, 4 Circuits, Tin (Sn) Plating

**Documents:**

[3D Model](#) [Product Specification PS-08-50 \(PDF\)](#)  
[Packaging Specification \(PDF\)](#) [RoHS Certificate of Compliance \(PDF\)](#)  
[Drawing \(PDF\)](#)

**Agency Certification**

CSA LR19980  
 UL E29179

**General**

Product Family PCB Headers  
 Series [41681](#)  
 Application Wire-to-Board  
 Product Name KK®

**Physical**

Breakaway Yes  
 Circuits (Loaded) 4  
 Circuits (maximum) 4  
 Color - Resin Black  
 Durability (mating cycles max) 25  
 Flammability 94V-0  
 Glow-Wire Compliant No  
 Lock to Mating Part None  
 Material - Metal Brass  
 Material - Plating Mating Tin  
 Material - Resin Polyester  
 Number of Rows 1  
 Orientation Vertical  
 PC Tail Length (in) 0.172 In  
 PC Tail Length (mm) 4.37 mm  
 PCB Locator No  
 PCB Retention None  
 PCB Thickness Recommended (in) 0.062 In  
 PCB Thickness Recommended (mm) 1.60 mm  
 Packaging Type Bag  
 Pitch - Mating Interface (in) 0.156 In  
 Pitch - Mating Interface (mm) 3.96 mm  
 Polarized to Mating Part No  
 Polarized to PCB No  
 Shrouded No  
 Stackable No  
 Temperature Range - Operating 0°C to +75°C  
 Termination Interface: Style Through Hole

**Electrical**

Current - Maximum per Contact 7A  
 Voltage - Maximum 250V

**Solder Process Data**

Lead-free Process Capability Wave Capable (TH only)

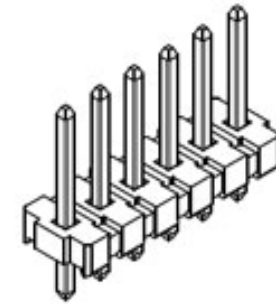

Series

image - Reference only

**EU RoHS**

**ELV and RoHS Compliant**  
**REACH SVHC**  
 Not Reviewed  
**Halogen-Free Status**

**China RoHS**



**Not Reviewed**

**Need more information on product environmental compliance?**

Email [productcompliance@molex.com](mailto:productcompliance@molex.com)  
 For a multiple part number RoHS Certificate of Compliance, [click here](#)

Please visit the [Contact Us](#) section for any non-product compliance questions.

**Search Parts in this Series**

[41681Series](#)

**Mates With**

[3069](#) , [2139](#) , [2145](#) , [6442](#) , [7674](#) , [7675](#) , [41695](#) , L ink:41815

**Material Info**

Old Part Number 41681A04A102

**Reference - Drawing Numbers**

Product Specification PS-08-50

Sales Drawing SD-41681-001

13 12 11 10 9 8 7 6 5 4 3 2 1

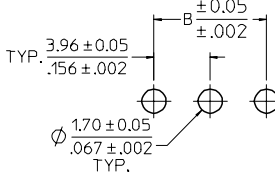
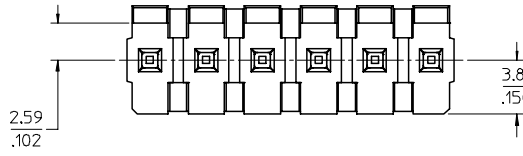
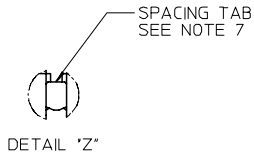

PCB LAYOUT: COMPONENT SIDE  
RECOMMENDED PCB THICKNESS:  
1.57 ± 0.18 / .062 ± .007

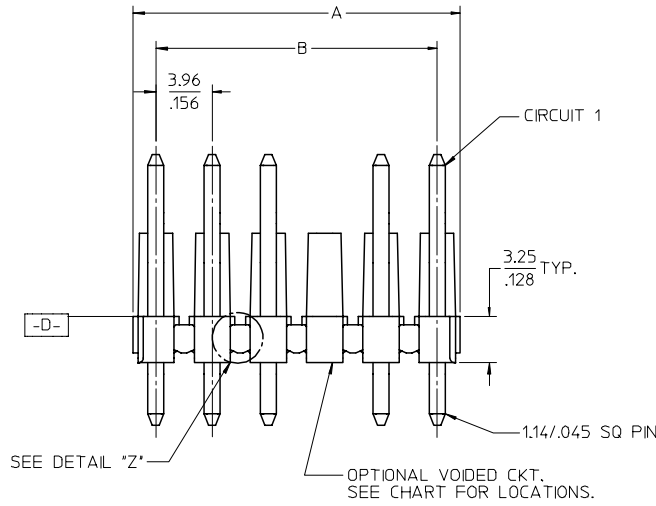
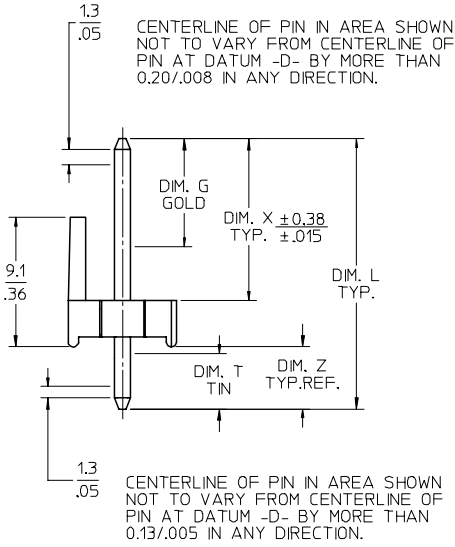

- NOTES:  
1. MATERIAL: HEADER: GLASS FILLED POLYESTER, 94V-0, MOLDED BLACK PINS- BRASS  
2. FINISH:  
(102) = OVERALL TIN: (0.00508)/.000200 MIN.  
OVERALL COPPER UNDERCOAT: (0.00254)/.000100 MIN.  
(208) = SELECT GOLD: (0.00038)/.000015 MIN. OVER  
SELECT TIN: (0.00254)/.000100 MIN. OVER  
NICKEL OVERALL: (0.000127)/.000050 MIN.  
(228) = SELECT GOLD: (0.00076)/.000030 MIN.  
SELECT TIN: (0.00254)/.000100 MIN.  
OVER NICKEL OVERALL: (0.00127)/.000050 MIN.  
(501) = OVERALL GOLD: (0.00051)/.000020 MIN.  
OVER NICKEL OVERALL: (0.00076)/.000030 MIN.  
(503) = OVERALL GOLD: (0.00076)/.000030 MIN.  
OVER NICKEL OVERALL: (0.00127)/.000050 MIN.

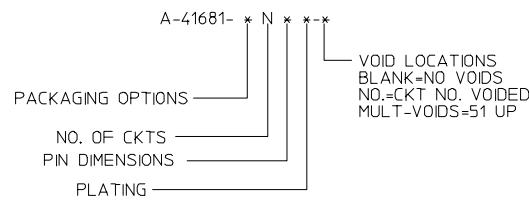

CIRCUIT	A	B
2	6.78/7.87 .267/.310	3.96 .156
3	10.74/11.84 .423/.466	7.92 .312
4	14.71/15.80 .579/.622	11.89 .468
5	18.67/19.76 .735/.778	15.85 .624
6	22.63/23.72 .891/.934	19.81 .780
7	26.59/27.69 1.047/1.090	23.77 .936
8	30.56/31.65 1.203/1.246	27.74 1.092
9	34.52/35.61 1.359/1.402	31.70 1.248
10	38.48/39.57 1.515/1.558	35.66 1.404
11	42.44/43.54 1.671/1.714	39.62 1.560
12	46.41/47.50 1.827/1.870	43.59 1.716
13	50.37/51.46 1.983/2.026	47.55 1.872
14	54.33/55.42 2.139/2.182	51.51 2.028
15	58.29/59.39 2.295/2.338	55.47 2.184
16	62.26/63.35 2.451/2.494	59.44 2.340
17	66.22/67.31 2.607/2.650	63.40 2.496
18	70.18/71.27 2.763/2.806	67.36 2.652
19	74.14/75.23 2.919/2.962	71.32 2.808
20	78.11/79.20 3.075/3.118	75.29 2.964
21	82.07/83.16 3.231/3.274	79.25 3.120
22	86.03/87.12 3.387/3.430	83.21 3.276
23	89.94/91.08 3.541/3.586	87.17 3.432
24	93.85/95.00 3.695/3.740	91.14 3.588

2-*	S2
1	S2
SHT.	REV.

- \* THE PRIMARY SHIPPING CARTON WILL BE LABELED "COMPLIANT TO RoHS DIRECTIVE 2002/95/EC AND ELV ANNEX II OF DIRECTIVE 2000/53/EC". CARTONS WITHOUT MAY CONTAIN PRODUCT WITH TIN/LEAD PLATINGS.  
3. PRODUCT SPECIFICATION: PS-08-50.  
4. PACKAGING: SEE CHART  
5. SOLDERABILITY: PER SMES-152.  
6. PIN PUSH-OUT FORCE: PRIOR TO SOLDERING, A 3 LB. MINIMUM FORCE IN EITHER DIRECTION SHALL BE REQUIRED TO PUSH THE PIN OUT OF THE HEADER.  
7. PARTS ARE STACKABLE END TO END ON 3.96/.156 CENTERS. (SPACING TABS MUST BE REMOVED ON CIRCUIT SIZES 1-23 BEFORE PARTS ARE STACKABLE.)

REVISED / REDRAWN	QUALITY SYMBOLS
EC NO: UCP2006-2983	▽=0
DRAWN/PRI/DER 2006/08/02	▽=0
CHKD:ADERR 2006/08/03	
APPR:FSM TH 2006/08/04	
DESCRIPTION	
REV	
S2	

GENERAL TOLERANCES (UNLESS SPECIFIED)	
mm	INCH
4 PLACES ± ---	± ---
3 PLACES ± ---	± .006
2 PLACES ± 0.15	± .010
1 PLACE ± 0.25	± ---
ANGULAR ±1/2°	
DRAFT WHERE APPLICABLE MUST REMAIN WITHIN DIMENSIONS	

DIMENSION STYLE	
MM/IN	
DRAWN BY	DATE
SAMIEC	08/09/85
CHECKED BY	DATE
PATEL	08/09/85
APPROVED BY	DATE
LENZ	08/09/85
MATERIAL NO.	DOCUMENT NO.
SEE CHART	SD-41681-001
THIS DRAWING CONTAINS INFORMATION THAT IS PROPRIETARY TO MOLEX INCORPORATED AND SHOULD NOT BE USED WITHOUT WRITTEN PERMISSION	

SCALE	DESIGN UNITS	THIRD ANGLE PROJECTION
4:1	INCH	⊙
KK .156 HEADER ASSEMBLY POLARIZING STRAIGHT 2-24 CKTS.		
MOLEX MOLEX INCORPORATED		
SHEET NO.		1 OF *

ENG. NO: A-41681-ANA102-*				ENG. NO: A-41681-ANA501-*				ENG. NO: A-41681-ANC102-*			
PIN NUMBER		2161-1(102)		PIN NUMBER		2161-1(501)		PIN NUMBER		2161-56(102)	
PLATING		102		PLATING		501		PLATING		102	
DIM. L		(19.05)/.750		DIM. L		(19.05)/.750		DIM. L		(17.86)/.703	
DIM. X		(11.43)/.450		DIM. X		(11.43)/.450		DIM. X		(11.43)/.450	
DIM. G (GOLD)		N/A		DIM. G (GOLD)		OVERALL		DIM. G (GOLD)		N/A	
DIM. Z		(4.37)/.172		DIM. Z		(4.37)/.172		DIM. Z		(3.18)/.125	
DIM. T (TIN)		OVERALL		DIM. T (TIN)		N/A		DIM. T (TIN)		OVERALL	
PACKAGING		PK-41681-001 (BULK)		PACKAGING		PK-41681-001 (BULK)		PACKAGING		PK-41681-001 (BULK)	
CKTS	EDP NO.	ENG. NO.	VOIDS	CKTS	EDP NO.	ENG. NO.	VOIDS	CKTS	EDP NO.	ENG. NO.	VOIDS
02	26-48-1023	A-41681-A2A102		02	26-48-2023	A-41681-A2A501		02	26-48-7025	A-41681-A2C102	
03	26-48-1033	A-41681-A3A102		03	26-48-2033	A-41681-A3A501		03	26-48-7035	A-41681-A3C102	
04	26-48-1043	A-41681-A4A102		04	26-48-2043	A-41681-A4A501		04	26-48-7045	A-41681-A4C102	
05	26-48-1053	A-41681-A5A102		05	26-48-2053	A-41681-A5A501		05	26-48-7055	A-41681-A5C102	
06	26-48-1063	A-41681-A6A102		06	26-48-2063	A-41681-A6A501		06	26-48-7065	A-41681-A6C102	
07	26-48-1073	A-41681-A7A102		07	26-48-2073	A-41681-A7A501		07	26-48-7075	A-41681-A7C102	
08	26-48-1083	A-41681-A8A102		08	26-48-2083	A-41681-A8A501		08	26-48-7085	A-41681-A8C102	
09	26-48-1093	A-41681-A9A102		09	26-48-2093	A-41681-A9A501		09	26-48-7095	A-41681-A9C102	
10	26-48-1103	A-41681-A10A102		10	26-48-2103	A-41681-A10A501		10	26-48-7105	A-41681-A10C102	
11	26-48-1113	A-41681-A11A102		11	26-48-2113	A-41681-A11A501		11	26-48-7115	A-41681-A11C102	
12	26-48-1123	A-41681-A12A102		12	26-48-2123	A-41681-A12A501		12	26-48-7125	A-41681-A12C102	
13	26-48-1133	A-41681-A13A102		13	26-48-2133	A-41681-A13A501		13	26-48-7135	A-41681-A13C102	
14	26-48-1143	A-41681-A14A102		14	26-48-2143	A-41681-A14A501		14	26-48-7145	A-41681-A14C102	
15	26-48-1153	A-41681-A15A102		15	26-48-2153	A-41681-A15A501		15	26-48-7155	A-41681-A15C102	
16	26-48-1163	A-41681-A16A102		16	26-48-2163	A-41681-A16A501		16	26-48-7165	A-41681-A16C102	
17	26-48-1173	A-41681-A17A102		17	26-48-2173	A-41681-A17A501		17	26-48-7175	A-41681-A17C102	
18	26-48-1183	A-41681-A18A102		18	26-48-2183	A-41681-A18A501		18	26-48-7185	A-41681-A18C102	
19	26-48-1193	A-41681-A19A102		19	26-48-2193	A-41681-A19A501		19	26-48-7195	A-41681-A19C102	
20	26-48-1203	A-41681-A20A102		20	26-48-2203	A-41681-A20A501		20	26-48-7205	A-41681-A20C102	
21	26-48-1213	A-41681-A21A102		21	26-48-2213	A-41681-A21A501		21	26-48-7215	A-41681-A21C102	
22	26-48-1223	A-41681-A22A102		22	26-48-2223	A-41681-A22A501		22	26-48-7225	A-41681-A22C102	
23	26-48-1233	A-41681-A23A102		23	26-48-2233	A-41681-A23A501		23	26-48-7235	A-41681-A23C102	
24	26-48-1243	A-41681-A24A102		24	26-48-2243	A-41681-A24A501		24	26-48-7245	A-41681-A24C102	
13	26-49-6137	A-41681-A13A102-12	12								
17	26-49-6177	A-41681-A17A102-2	2								
20	26-49-6207	A-41681-A20A102-17	17								

www.DataSheet4U.com

<b>S2</b>	REV:	ECR/ECN INFORMATION	TITLE:	KK .156 HEADER ASSEMBLY POLARIZING STRAIGHT 2-24 CKTS	SHEET No.		
		EC No: <b>UCP2006-2983</b>			<b>- 2 -</b>		
		DATE: <b>2006-06-13</b>					
DOCUMENT NUMBER:		CREATED / REVISED BY:		CHECKED BY:		APPROVED BY:	
<b>SD-41681-001</b>		<b>PRIDDER</b>		<b>ADERR</b>		FSMITH www.DataSheet4U.com	

ENG. NO: A-41681-ANC503*				ENG. NO: A-41681-BNA208*				ENG. NO: A-41681-BNA228*			
PIN NUMBER		2161-56(503)		PIN NUMBER		43294-0236		PIN NUMBER		43294-0237	
PLATING		503		PLATING		208		PLATING		228	
DIM. L		(17.86)/.703		DIM. L		(19.05)/.750		DIM. L		(19.05)/.750	
DIM. X		(11.43)/.450		DIM. X		(11.43)/.450		DIM. X		(11.43)/.450	
DIM. G (GOLD)		OVERALL		DIM. G (GOLD)		(6.86)/.270		DIM. G (GOLD)		(6.86)/.270	
DIM. Z		(3.18)/.125		DIM. Z		(4.37)/.172		DIM. Z		(4.37)/.172	
DIM. T (TIN)		N/A		DIM. T (TIN)		(4.06)/.160		DIM. T (TIN)		(4.06)/.160	
PACKAGING		PK-41681-001 (BULK)		PACKAGING		PK-41681-001 (BULK)		PACKAGING		PK-41681-001 (BULK)	
CKTS	EDP NO.	ENG. NO.	VOIDS	CKTS	EDP NO.	ENG. NO.	VOIDS	CKTS	EDP NO.	ENG. NO.	VOIDS
02	26-48-7028	A-41681-A2C503		02	41681-0001	A-41681-B02A208		02	41681-0024	A-41681-B02A228	
03	26-48-7038	A-41681-A3C503		03	41681-0002	A-41681-B03A208		03	41681-0025	A-41681-B03A228	
04	26-48-7048	A-41681-A4C503		04	41681-0003	A-41681-B04A208		04	41681-0026	A-41681-B04A228	
05	26-48-7058	A-41681-A5C503		05	41681-0004	A-41681-B05A208		05	41681-0027	A-41681-B05A228	
06	26-48-7068	A-41681-A6C503		06	41681-0005	A-41681-B06A208		06	41681-0028	A-41681-B06A228	
07	26-48-7078	A-41681-A7C503		07	41681-0006	A-41681-B07A208		07	41681-0029	A-41681-B07A228	
08	26-48-7088	A-41681-A8C503		08	41681-0007	A-41681-B08A208		08	41681-0030	A-41681-B08A228	
09	26-48-7098	A-41681-A9C503		09	41681-0008	A-41681-B09A208		09	41681-0031	A-41681-B09A228	
10	26-48-7108	A-41681-A10C503		10	41681-0009	A-41681-B10A208		10	41681-0032	A-41681-B10A228	
11	26-48-7118	A-41681-A11C503		11	41681-0010	A-41681-B11A208		11	41681-0033	A-41681-B11A228	
12	26-48-7128	A-41681-A12C503		12	41681-0011	A-41681-B12A208		12	41681-0034	A-41681-B12A228	
13	26-48-7138	A-41681-A13C503		13	41681-0012	A-41681-B13A208		13	41681-0035	A-41681-B13A228	
14	26-48-7148	A-41681-A14C503		14	41681-0013	A-41681-B14A208		14	41681-0036	A-41681-B14A228	
15	26-48-7158	A-41681-A15C503		15	41681-0014	A-41681-B15A208		15	41681-0037	A-41681-B15A228	
16	26-48-7168	A-41681-A16C503		16	41681-0015	A-41681-B16A208		16	41681-0038	A-41681-B16A228	
17	26-48-7178	A-41681-A17C503		17	41681-0016	A-41681-B17A208		17	41681-0039	A-41681-B17A228	
18	26-48-7188	A-41681-A18C503		18	41681-0017	A-41681-B18A208		18	41681-0040	A-41681-B18A228	
19	26-48-7198	A-41681-A19C503		19	41681-0018	A-41681-B19A208		19	41681-0041	A-41681-B19A228	
20	26-48-7208	A-41681-A20C503		20	41681-0019	A-41681-B20A208		20	41681-0042	A-41681-B20A228	
21	26-48-7218	A-41681-A21C503		21	41681-0020	A-41681-B21A208		21	41681-0043	A-41681-B21A228	
22	26-48-7228	A-41681-A22C503		22	41681-0021	A-41681-B22A208		22	41681-0044	A-41681-B22A228	
23	26-48-7238	A-41681-A23C503		23	41681-0022	A-41681-B23A208		23	41681-0045	A-41681-B23A228	
24	26-48-7248	A-41681-A24C503		24	41681-0023	A-41681-B24A208		24	41681-0046	A-41681-B24A228	

www.DataSheet4U.com

<b>S2</b>	REV:	ECR/ECN INFORMATION	TITLE:	<b>KK .156 HEADER ASSEMBLY POLARIZING STRAIGHT 2-24 CKTS</b>	SHEET No.		
		EC No: <b>UCP2006-2983</b>			<b>- 3 -</b>		
		DATE: <b>2006-06-13</b>					
DOCUMENT NUMBER:		CREATED / REVISED BY:		CHECKED BY:		APPROVED BY:	
<b>SD-41681-001</b>		<b>PRIDDER</b>		<b>ADERR</b>		<b>FSMITH</b> <a href="http://www.DataSheet4U.com">www.DataSheet4U.com</a>	

ENG. NO: A-41681-ANB102*				ENG. NO				ENG. NO			
PIN NUMBER		2161-1(102)		PIN NUMBER				PIN NUMBER			
PLATING		102		PLATING				PLATING			
DIM. L		(19.05)/.750		DIM. L				DIM. L			
DIM. X		(12.62)/.497		DIM. X				DIM. X			
DIM. G (GOLD)		N/A		DIM. G (GOLD)				DIM. G (GOLD)			
DIM. Z		(3.18)/.125		DIM. Z				DIM. Z			
DIM. T (TIN)		OVERALL		DIM. T (TIN)				DIM. T (TIN)			
PACKAGING		PK-41681-001 (BULK)		PACKAGING		PK-41681-001 (BULK)		PACKAGING		PK-41681-001 (BULK)	
CKTS	EDP NO.	ENG. NO.	VOIDS	CKTS	EDP NO.	ENG. NO.	VOIDS	CKTS	EDP NO.	ENG. NO.	VOIDS
02	41681-0047	A-41681-A2B102		02				02			
03	41681-0048	A-41681-A3B102		03				03			
04	41681-0049	A-41681-A4B102		04				04			
05	41681-0050	A-41681-A5B102		05				05			
06	41681-0051	A-41681-A6B102		06				06			
07	41681-0052	A-41681-A7B102		07				07			
08	41681-0053	A-41681-A8B102		08				08			
09	41681-0054	A-41681-A9B102		09				09			
10	41681-0055	A-41681-A10B102		10				10			
11	41681-0056	A-41681-A11B102		11				11			
12	41681-0057	A-41681-A12B102		12				12			
13	41681-0058	A-41681-A13B102		13				13			
14	41681-0059	A-41681-A14B102		14				14			
15	41681-0060	A-41681-A15B102		15				15			
16	41681-0061	A-41681-A16B102		16				16			
17	41681-0062	A-41681-A17B102		17				17			
18	41681-0063	A-41681-A18B102		18				18			
19	41681-0064	A-41681-A19B102		19				19			
20	41681-0065	A-41681-A20B102		20				20			
21	41681-0066	A-41681-A21B102		21				21			
22	41681-0067	A-41681-A22B102		22				22			
23	41681-0068	A-41681-A23B102		23				23			
24	26-48-6248	A-41681-A24B102		24				24			

www.DataSheet4U.com

REV: <b>S2</b>	<u>ECR/ECN INFORMATION</u>		<u>TITLE:</u> <b>KK .156 HEADER ASSEMBLY POLARIZING STRAIGHT 2-24 CKTS</b>	<u>SHEET No.</u> <b>- 4 -</b>
	EC No: <b>UCP2006-2983</b>			
	DATE: <b>2006-06-13</b>			
<u>DOCUMENT NUMBER:</u> <b>SD-41681-001</b>		<u>CREATED / REVISED BY:</u> <b>PRIDDER</b>	<u>CHECKED BY:</u> <b>ADERR</b>	<u>APPROVED BY:</u> <b>FSMITH</b> www.DataSheet4U.com