



LINEAR INTEGRATED CIRCUITS

SG1627/SG2627/SG3627**DUAL HIGH-CURRENT OUTPUT DRIVER****DESCRIPTION**

The SG1627 series devices are monolithic, high-speed driver integrated circuits designed to interface digital control logic with high current loads. Each device contains two independent drivers which will either source or sink up to 500mA of current. The sink transistor is designed as a saturating switch while the source transistor can be used either as a switch or as a constant current generator with external resistor programming.

Each half of this device contains both inverting and non-inverting inputs which have two volt thresholds for high noise immunity. Either input can be used alone to switch the output, or one input can be strobed with the other. These units have been designed to directly interface with the SG1524 Regulating Pulse Width Modulator Circuit.

These devices are supplied in ceramic 16-pin D.I.L. packages. The SG1627 is specified for operation over a -55°C to $+125^{\circ}\text{C}$ ambient temperature range while the SG2627 is intended for industrial applications of -25°C to 85°C and the SG3627 for 0°C to 70°C .

FEATURES

- Two independent driver circuits
- Outputs will source or sink currents to 500mA
- 300ns response time
- Full compatibility with SG1524 PWM circuit
- Constant current drive capability
- Two volt threshold for high noise immunity
- Source and sink can be separated for complementary outputs

HIGH RELIABILITY FEATURES - SG1627

- ♦ Available to MIL-STD-883
- ♦ SG level "S" processing available

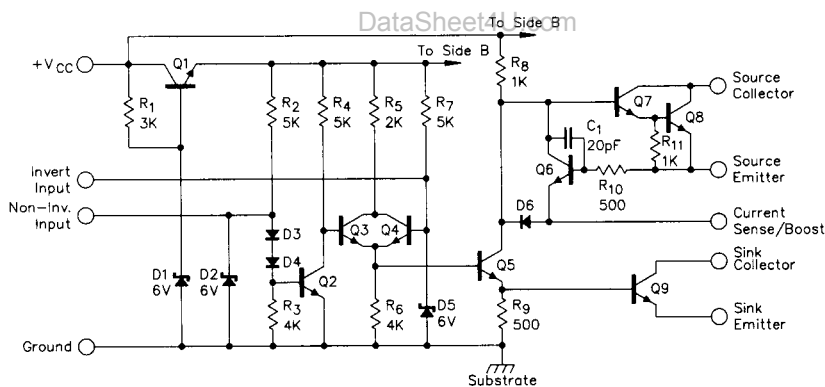
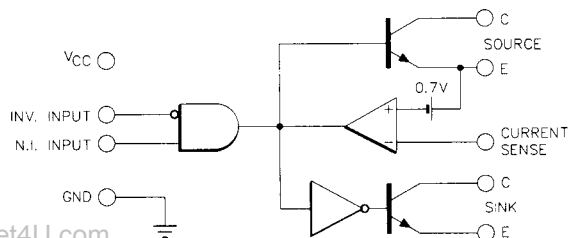
SCHEMATIC (one-half of total device shown)**BLOCK DIAGRAM** (one-half of total device shown)**FUNCTION TABLE**

NON INV.	INV.	SINK	SOURCE
LO	OPEN	ON	OFF
OPEN	LO	OFF	ON
OPEN	OPEN	ON	OFF
LO	LO	ON	OFF

ABSOLUTE MAXIMUM RATINGS (Note 1)

Supply Voltage, V_{CC}	
SG1627, 2627	30V
SG3627	20V
Output Collector Voltage	
SG1627, 2627	30V
SG3627	20V
Source or Sink Current, DC	500mA

Peak Current (< 2% duty cycle)	1A
Input Voltage Range	-0.3V to 5.5V
Input Current	10mA
Operating Junction Temperature	
Hermetic (J Package)	150°C
Storage Temperature Range	-65°C to 150°C
Lead Temperature (Soldering, 10 Seconds)	300°C

Note 1. Exceeding these ratings could cause damage to the device.

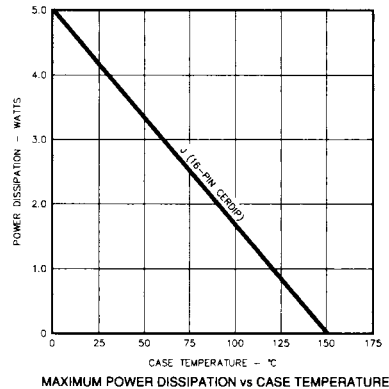
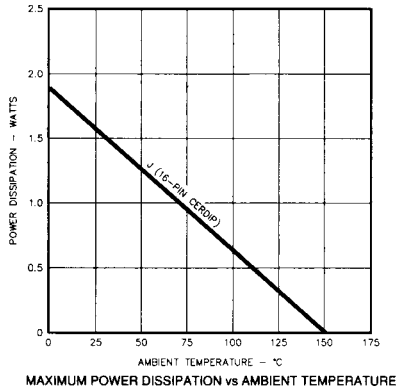
THERMAL DERATING CURVES**RECOMMENDED OPERATING CONDITIONS** (Note 2)

Supply Voltage, V_{CC}	
SG1627, 2627	5V to 30V
SG3627	5V to 20V
Output Collector Voltage	
SG1627, 2627	5V to 30V
SG3627	5V to 20V
Source or Sink Current, DC	0mA to 500mA

Peak Current (< 2% duty cycle)	0mA to 750mA
Input Voltage	0V to 5.5V
Input Current	0mA to 10mA
Operating Ambient Temperature Range	
SG1627	-55°C to 125°C
SG2627	-25°C to 85°C
SG3627	0°C to 70°C

Note 2. Range over which the device is functional.

ELECTRICAL SPECIFICATIONS

(Unless otherwise specified, these specifications apply over the operating ambient temperatures for SG1627 with $-55^{\circ}\text{C} \leq T_A \leq 125^{\circ}\text{C}$, SG2627 with $-25^{\circ}\text{C} \leq T_A \leq 85^{\circ}\text{C}$, SG3627 with $0^{\circ}\text{C} \leq T_A \leq 70^{\circ}\text{C}$, and $V_{CC} = 5\text{V}$. Low duty cycle pulse testing techniques are used which maintains junction and case temperatures equal to the ambient temperature.)

Parameter	Test Conditions	SG1627/2627/3627			Units
		Min.	Typ.	Max.	
High-Level Input Voltage		2.8		5.5	V
Low-Level Input Voltage		0		1.4	V
Input Threshold			2.0		V _{CC}
Low-Level Input Current	$V_{IN} = 0\text{V}$		-1.0	-2.0	mA
Source Off, Leakage Current	Collector $V = V_{MAX}$		0.3	1.0	mA
Source On, Collector Saturation	$I_{SOURCE} = 50\text{mA}$		1.1	1.7	V
(Source Emitter Grounded, $R_{SC} = 0$)	$I_{SOURCE} = 300\text{mA}$		1.2	1.9	V
	$I_{SOURCE} = 500\text{mA}$			1.3	V
	$I_{SOURCE} = -50\text{mA}$	$V_{CC} = 3\text{V}$			V
Source On, Emitter Voltage	Collector $V = V_{MAX}$		1.0	100	μA
Sink Off, Leakage Current	$I_{SINK} = 50\text{mA}$		0.2	0.4	V
Sink On, Collector Saturation	$I_{SINK} = 300\text{mA}, V_{CC} = 20\text{V}$		0.5	0.7	V
	$I_{SINK} = 500\text{mA}, I_{BOOST} = 25\text{mA}$		0.5		V
	$R_{SC} = 10\Omega, T_A = 25^{\circ}\text{C}$	600	700	900	mV
Current Limit Sense Voltage	$R_{SC} = 10\Omega$		1.8		mV/°C

ELECTRICAL SPECIFICATIONS (continued)

Parameter	Test Conditions	SG1627/2627/3627			Units
		Min.	Typ.	Max.	
Supply Current (both sink transistors on)	$V_{CC} = 5V$ $V_{CC} = 20V$ $V_{CC} = 30V$ (1627/2627 only)		15	22	mA
Response Time (TRHL)	Fig. 12, $R_L = 24\Omega$, $T_A = 25^\circ C$		80	73	ns
Response Time (TRLH)	Fig. 12, $R_L = 24\Omega$, $T_A = 25^\circ C$		100	115	ns
			300		ns

CHARACTERISTIC CURVES

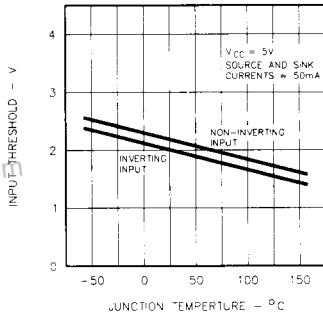

FIGURE 1.
INPUT THRESHOLD VS. TEMPERATURE

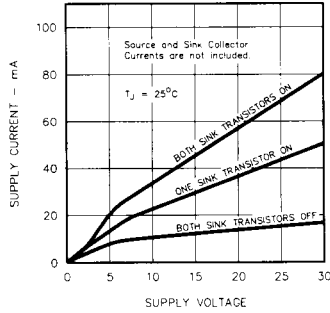

FIGURE 2.
 V_{CC} SUPPLY CURRENT VS. VOLTAGE

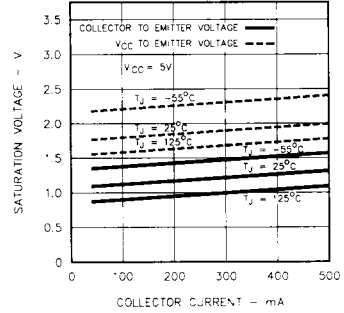

FIGURE 3.
SOURCE TRANSISTOR SATURATION

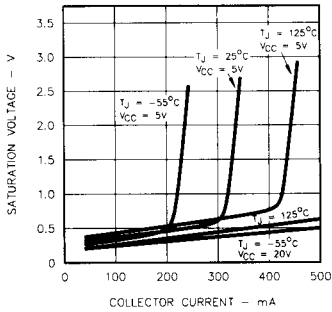

FIGURE 4.
SINK TRANSISTOR SATURATION

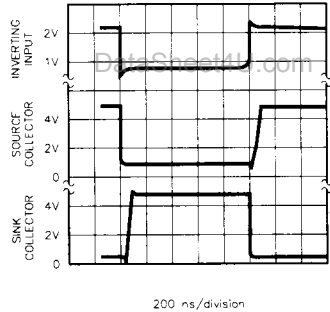

FIGURE 5.
DYNAMIC RESPONSE
(See Fig. 12 for Test Circuit, $R_L = 24\Omega$)

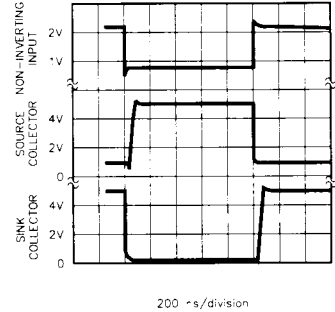

FIGURE 6.
DYNAMIC RESPONSE
(See Fig. 12 for Test Circuit, $R_L = 24\Omega$)

APPLICATION INFORMATION

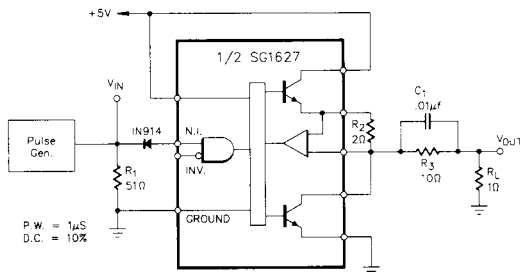

FIGURE 7 - TOTEM POLE OUTPUT SWITCH CIRCUIT

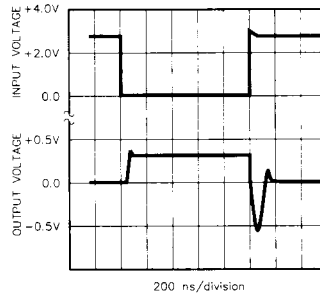

FIGURE 8 - OUTPUT WAVEFORM

APPLICATION CIRCUITS

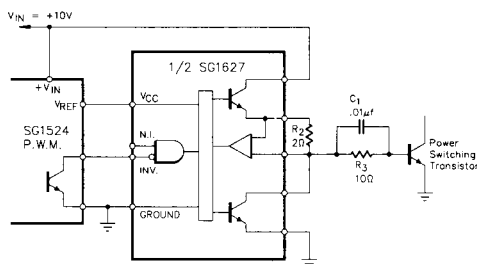

FIGURE 9

Basic 300mA switched drive circuit. If the external output transistor is to be on when the driving transistor is on, use the inverting input with the non-inverting input left open. For opposite phasing, use the non-inverting input with the inverting input grounded.

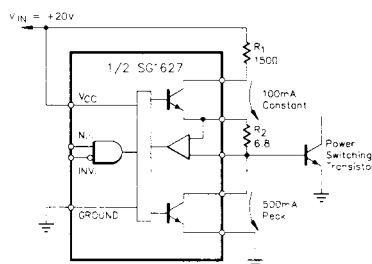

FIGURE 10

Use of higher input voltage provides greater drive for higher sink-transistor peak current while R2 provides constant source current. R1 helps minimize power in the SG1627. Although the sink emitter may be connected to a different ground point from pin 5, any voltage differences between them will directly affect the input threshold level.

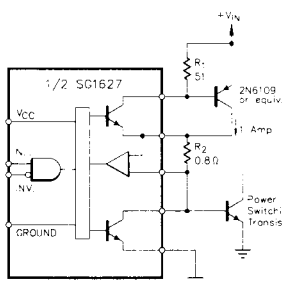

FIGURE 11

Additional source current or power handling capability may be added with the use of an external PNP transistor. For optimum performance, a low storage-time unit should be selected. If current limiting is not required, an NPN emitter follower could also be used for source boost.

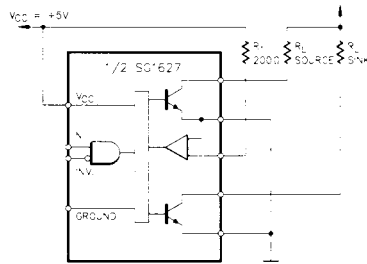

FIGURE 12

Source and sink transistors can be used separately for complementary outputs. At low supply voltages the sink current is limited to approximately 100mA, but if current limiting is not required a sink drive boost may be added with R1. The current in R1 should be .05 times the sink load current to insure saturation.

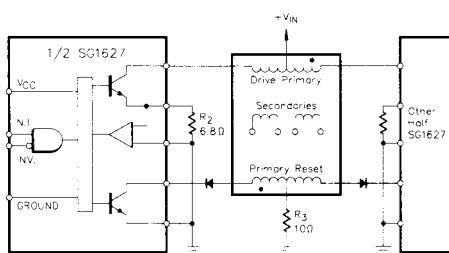

FIGURE 13

Source and sink transistors can be used separately for an efficient transformer driver. Here the source provides constant current drive with magnetic reset accomplished by a flux clamp utilizing the sink transistor. With the source current sense terminal connected to ground, there will be a residual collector current of approximately 300μA. If this is objectionable, insert a diode between current sense and ground.

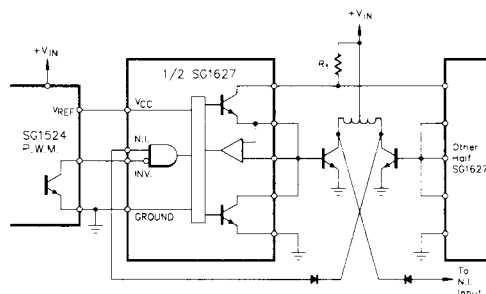

FIGURE 14

Simultaneous conduction of the output switching transistors can be positively prevented by using diodes to cross-couple a gating signal into the non-inverting inputs. For maximum power handling capability, the source transistor is driven into saturation with the current limiting provided by R1.

CONNECTION DIAGRAMS & ORDERING INFORMATION (See Notes Below)

Package	Part No.	Ambient Temperature Range	Connection Diagram
16-PIN CERAMIC DIP J - PACKAGE	SG1627J/883B	-55°C to 125°C	SINK C (A) ... 1 ... 16 ... CURRENT SENSE (A) SINK E (A) ... 2 ... 15 ... SOURCE E (A) INV. (A) ... 3 ... 14 ... SOURCE C (A) N.I. (A) ... 4 ... 13 ... V _{cc} GROUND ... 5 ... 12 ... INV. (B) N.I. (B) ... 6 ... 11 ... SOURCE C (B) SINK E (B) ... 7 ... 10 ... SOURCE E (B) SINK C (B) ... 8 ... 9 ... CURRENT SENSE (B)
	SG1627J	-55°C to 125°C	
	SG2627J	-25°C to 85°C	
	SG3627J	0°C to 70°C	

DataSheet4U.com

6

Note 1. Contact factory for JAN and DESC product availability.
 2. All packages are viewed from the top.