

3.5 AMP POWER OP AMP

DESCRIPTION

The SG1173 is a power monolithic operational amplifier capable of operating with loads to 3.5A with a power supply range to $\pm 24V$. Thermal shutdown and current limit have been provided to insure reliable operation during heavy loading. In addition, the SG1173's high common mode rejection, low input offsets, and high open loop gain rival those of much lower power op amps. Another important feature not provided by competitive power amps is the low quiescent current enabling significant power savings under no load conditions.

The SG1173 is ideal for use with voice coils in Winchester disk drives and other linear servo applications required by the automotive and military industries.

FEATURES

- Low quiescent current
- 3.5A output current
- Supply voltage range from $\pm 5V$ to $\pm 24V$
- Internally compensated
- Thermal shutdown protection
- Current limit protection
- Functional replacements for ULN3751, L165, and LM675
- Available in TO-220, TO-66 packages

**HIGH RELIABILITY FEATURES
- SG1173**

- ◆ Available to MIL-STD-883
- ◆ SG level "S" processing available

EQUIVALENT CIRCUIT SCHEMATIC

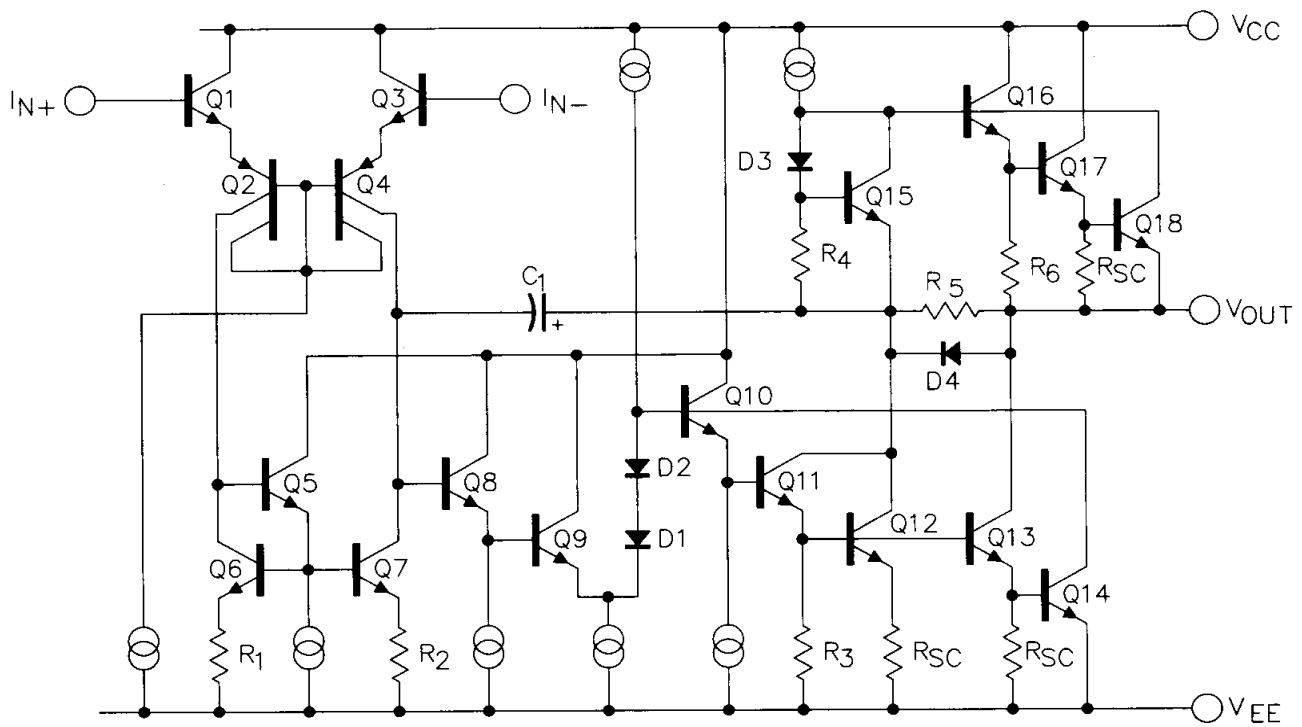

ABSOLUTE MAXIMUM RATINGS (Note 1)

Positive Supply Voltage (V_{CC}) 25V
 Negative Supply Voltage (V_{EE}) -25V
 Differential Input Voltage (Note 2) $\pm 50V$
 Common Mode Voltage (Note 2) $\pm 25V$
 Output Current $\pm 4A$

Operating Junction Temperature
 Hermetic (R-Package) 150°C
 Plastic (P-Package) 150°C
 Storage Temperature Range -65°C to 150°C
 Lead Temperature (Soldering, 10 Seconds) 300°C

Note 1. Exceeding these ratings could cause damage to the device. All voltages are with respect to ground. All currents are positive into the specified terminal.

Note 2. Either or both input voltages must not exceed the magnitude of V_{CC} or V_{EE} .

THERMAL DERATING CURVES

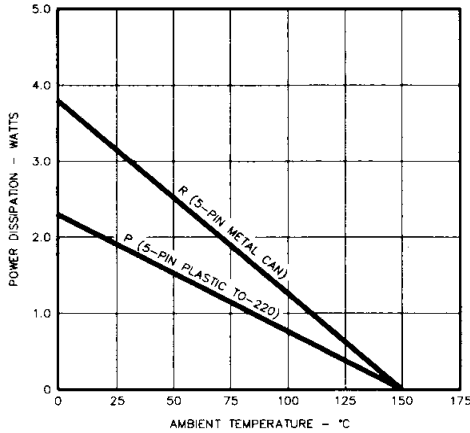

MAXIMUM POWER DISSIPATION vs AMBIENT TEMPERATURE

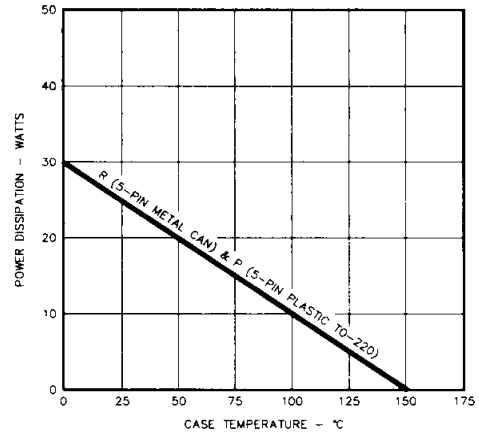

MAXIMUM POWER DISSIPATION vs CASE TEMPERATURE

RECOMMENDED OPERATING CONDITIONS (Note 3)

Supply Voltage Range (V_{CC}) +5V to +24V
 Supply Voltage Range (V_{EE}) -5V to -24V
 Output Current (Continuous) $\pm 3.5A$

Operating Ambient Temperature Range
 SG1173 -55°C to 125°C
 SG2173 -45°C to 85°C
 SG3173 0°C to 70°C

Note 3. Range over which the device is functional.

ELECTRICAL SPECIFICATIONS

(Unless otherwise specified, these specifications apply over full operating ambient temperatures for SG1173 with $-55^\circ C \leq T_A \leq 125^\circ C$, SG2173 with $-25^\circ C \leq T_A \leq 85^\circ C$, SG 3173 with $0^\circ C \leq T_A \leq 70^\circ C$, $V_{CC} = +15V$, and $V_{EE} = -15V$. Low duty cycle pulse testing techniques are used which maintains junction and case temperatures equal to the ambient temperature.)

| Parameter | Test Conditions | SG1173/2173 | | | SG3173 | | | Units |
|------------------------------|---|-------------|------|----------|---------|------|----------|------------|
| | | Min. | Typ. | Max. | Min. | Typ. | Max. | |
| Supply Voltage Range | | ± 5 | | ± 24 | ± 5 | | ± 24 | V |
| Quiescent Drain Current | $I_{OUT} = 0$ | | 10 | 20 | | 10 | 20 | mA |
| Input Offset Voltage | $V_{OUT} = 0V, I_{OUT} = 0$ $T_A = 25^\circ C$ | | 2 | 8 | | 2 | 8 | mV |
| Input Bias Current | $V_{OUT} = 0V, I_{OUT} = 0$ $T_A = 25^\circ C$ | | | 1000 | | | 1000 | nA |
| Input Offset Current | $V_{OUT} = 0V, I_{OUT} = 0$ $T_A = 25^\circ C$ | | | 250 | | | 250 | nA |
| Output Voltage Swing | $I_{OUT} = -2A$ $T_A = 25^\circ C$ | | | 2.8 | | | 2.8 | V |
| | $I_{OUT} = +2A$ $T_A = 25^\circ C$ | | | 3.5 | | | 3.5 | V |
| | $I_{OUT} = 0$ $T_A = 25^\circ C$ | | | 5.5 | | | 5.5 | V |
| Current Limit | $V_{OUT} = 0V$ | | 5 | 6.5 | | 5 | 6.5 | A |
| Common Mode Rejection Ratio | $\Delta V_{CM} = \pm 10V$ | 70 | | | 70 | | | dB |
| Power Supply Rejection Ratio | $\Delta V_{CC}, \Delta V_{EE} = \pm 5V$ | 74 | | | 74 | | | dB |
| Open Loop Voltage Gain | $I_{OUT} = 0A$ $T_A = 25^\circ C$ | 75 | | | 75 | | | dB |
| Slew Rate | | 80 | | | 80 | | | dB |
| Gain Bandwidth Product | | | 0.5 | | | 0.5 | | V/ μs |
| Thermal Shutdown | | | 600 | | | 600 | | KHz |
| | | | 175 | | | 175 | | $^\circ C$ |

CHARACTERISTIC CURVES

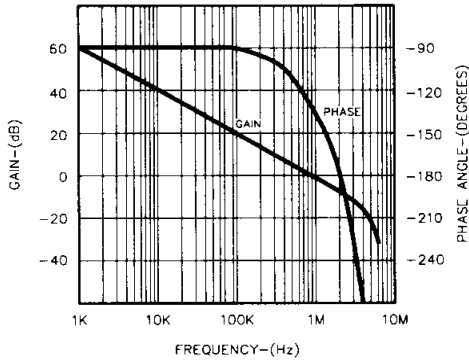

FIGURE 1. FREQUENCY RESPONSE

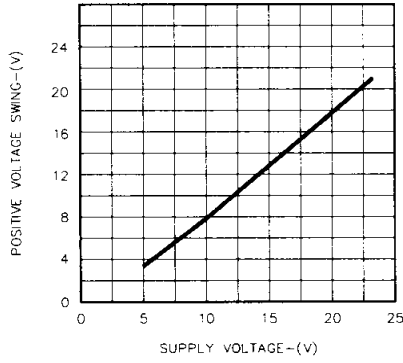

FIGURE 2. POSITIVE VOLTAGE SWING VS. SUPPLY VOLTAGE

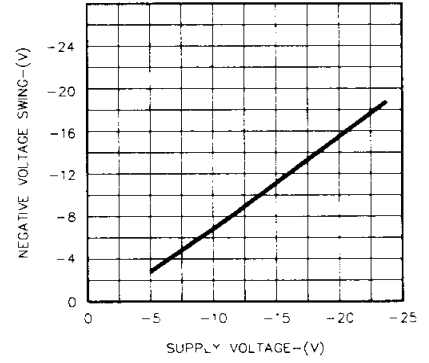

FIGURE 3. NEGATIVE VOLTAGE SWING VS. SUPPLY VOLTAGE

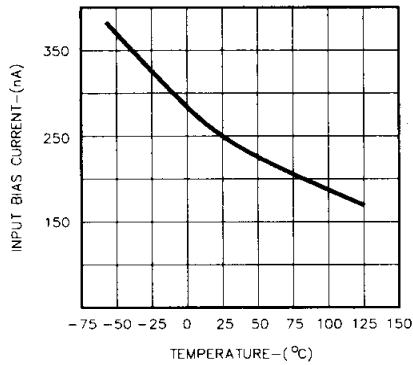

FIGURE 4. INPUT BIAS CURRENT VS. TEMPERATURE

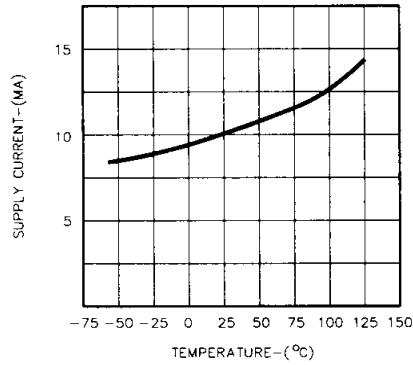

FIGURE 5. SUPPLY CURRENT VS. TEMPERATURE

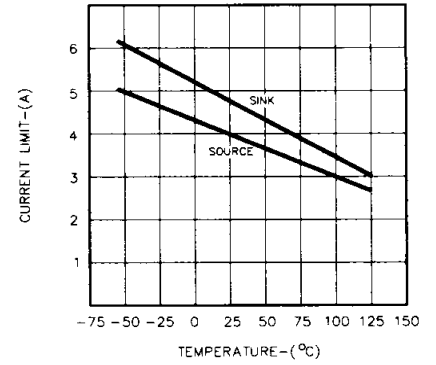

FIGURE 6. CURRENT LIMIT VS. TEMPERATURE

APPLICATION INFORMATION

General usage of the SG1173 requires the same design and layout considerations used with other op amps. Power supplies should be adequately bypassed and clamped with Zener diodes if transients are a problem. Leads to high impedance nodes should be kept as short as possible to minimize undesirable input-output coupling or RF pick-up. In addition to these, the high current capability of the SG1173 presents some new challenges that a designer must be aware of. Special care should be taken to avoid spurious feedback due to ground loops or voltage drops in high current paths. Kelvin connections should be used when applicable. When driving inductive loads, protection diode must

be used to clamp the output voltage to the power supplies (Figure 7). This protects the amplifier from high voltage transients caused by the stored energy in the inductor. Some loads may require external load compensation. Examples of this are shown in Figures 8 and 9. Safe operating area (SOA) is another area where extreme care must be used. Simultaneous conditions of high current and high voltage on the part may cause the junction temperature to exceed the maximum rating. In any application, the worst case power dissipations should be calculated and adequate heat sinking must be provided.

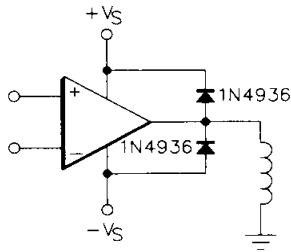

FIGURE 7 - PROTECTION DIODES USED WITH INDUCTIVE LOAD

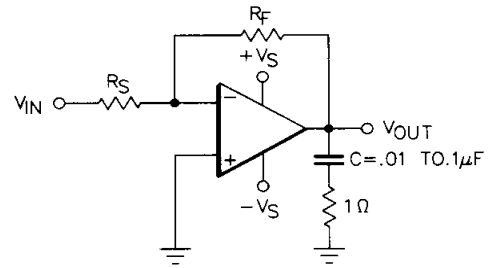

FIGURE 8 - INVERTING AMPLIFIER WITH RC LOAD COMPENSATION

APPLICATION INFORMATION (continued)

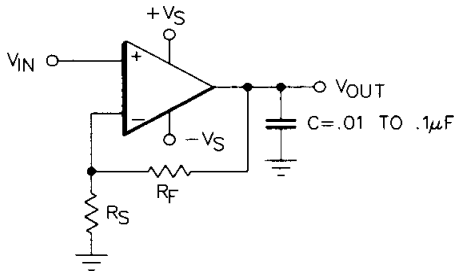

FIGURE 9 - NON-INVERTING AMPLIFIER WITH CAPACITIVE LOAD COMPENSATION

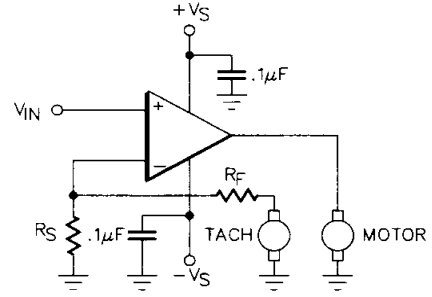

FIGURE 10 - MOTOR SPEED CONTROL WITH TACHOMETER FEEDBACK

A simple motor control loop is shown in Figure 10. This loop regulates the speed of the motor by using a tachometer to generate a voltage proportional to motor speed that is fed back to the amplifier. If the speed of the motor is S rpm and the proportionality constant of the tachometer is K volts/rpm then

$$S = V_{IN} \frac{(1 + R_F/R_S)}{K}$$

The speed of the motor is set by the input voltage V_{IN} regardless of the load on the motor. This is because the action of the feedback loop forces the voltage on the motor to whatever value is required to maintain the desired speed. If it is shaft position rather than speed that needs to be regulated then the tachometer may be replaced by some type of shaft encoder that generates a voltage proportional to the position of the motor shaft. In this case the input voltage will set the shaft angle according to the relation

$$\omega = V_{IN} \frac{(1 + R_F/R_S)}{H}$$

where ω is shaft angle in degrees and H is the proportionality constant of the shaft encoder in volts/degree.

The new op amp has the capability to drive a loudspeaker directly allowing it to be used as an amplifier. Standard op amp configurations can be used to design amplifiers with particular values of closed loop gain or bandwidth. An example of such a circuit is shown in Figure 11. This circuit utilizes the op amp in a non-inverting gain configuration. The midband closed loop gain is set by R_F and R_S . The product of R_S and C_S set the lower 3dB frequency. The upper 3dB frequency is a function of the op amp's bandwidth and closed loop gain. A capacitor in parallel with R_S can be used to set the upper 3dB frequency to lower values if desired.

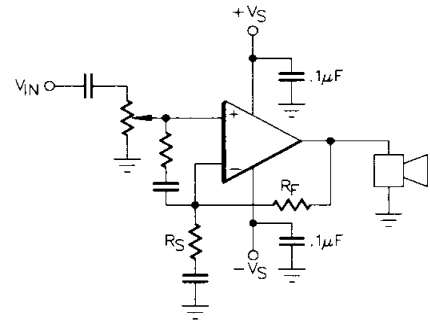

FIGURE 11 - AUDIO AMPLIFIER

CONNECTION DIAGRAMS & ORDERING INFORMATION (See Notes Below)

| Package | Part No. | Ambient Temperature Range | Connection Diagram |
|-----------------------------------|---|--|--------------------|
| 5-PIN TO-220 PLASTIC P - PACKAGE | SG2173P SG3173P | -45°C to 85°C 0°C to 70°C | |
| 5-PIN TO-66 METAL CAN R - PACKAGE | SG1173R/883B SG1173R SG2173R SG3173R | -55°C to 125°C -55°C to 125°C -45°C to 85°C 0°C to 70°C | |

Note 1. Contact factory for JAN and DESC product availability.

Note 2. All packages are viewed from the top.