

TFT COLOR LCD MODULE

NL128102AC23-02A

**39 cm (15.4 inches), 1280 × 1024 pixels, Full-color,
Multi-scan Function
Incorporated backlight with inverter**

DESCRIPTION

NL128102AC23-02A is a TFT (thin film transistor) active matrix color liquid crystal display (LCD) comprising amorphous silicon TFT attached to each signal electrode, a driving circuit and backlight. NL128102AC23-02A has a built-in backlight with an inverter.

The 39 cm (15.4 inches) diagonal display area contains 1280 × 1024 pixels and can display full-color (more than 16 million colors simultaneously). Also, it has multi-scan function.

NL128102AC23-02A is a model which mounted the CRT interface board on NL128102AC23-02.

FEATURES

- Wide viewing angle (with retardation film)
- CRT interface board
- Auto recognition of input signal (Analog RGB signals, Synchronous signals (Hsync, Vsync, Composite))
- Digital control: e.g., Brightness, Display position, contrast, CLK delay
- Free supply voltage sequence
- Corresponding to DDC™1 and DDC2B
- Corresponding to VESA™, DPMS™
- On Screen Display

Regarding the use of OSD, please note that there is possibility of conflicts with a patent in Europe and the U.S. Thus, if such conflict might happen when you use OSD, we shall not be responsible for any trouble.

- High luminance (200 cd/m², TYP.)
- Low reflection
- Multi-scan function: e.g., SXGA, XGA, SVGA, VGA, VGA-TEXT, MAC
- Incorporated edge type backlight with an inverter (Four lamps into two lamp holders)
- Lamp holder replaceable

VESA : Video Electronics Standards Association

DDC1 : Display Data Channel 1

DPMS: Display Power Management Signaling

DDC2B: Display Data Channel 2B

All trademarks used within this document are the property of their respective owners. VESA, DDC, DPMS and EDID are trademarks of the Video Electronics Standard Association.

APPLICATIONS

- Desk-top type of PC
- Engineering work station



The information in this document is subject to change without notice.

STRUCTURE AND FUNCTIONS

A color TFT (thin film transistor) LCD module is comprised of a TFT liquid crystal panel structure, LSIs for driving the TFT array, and a backlight assembly. The TFT panel structure is created by sandwiching liquid crystal material in the narrow gap between a TFT array glass substrate and a color filter glass substrate. After the driver LSIs are connected to the panel, the backlight assembly is attached to the backside of the panel.

RGB (red, green, blue) data signals from a source system is modulated into a form suitable for active matrix addressing by the onboard signal processor and sent to the driver LSIs which in turn addresses the individual TFT cells.

Acting as an electro-optical switch, each TFT cell regulates light transmission from the backlight assembly when activated by the data source. By regulating the amount of light passing through the array of red, green, and blue dots, color images are created with clarity.

BLOCK DIAGRAM

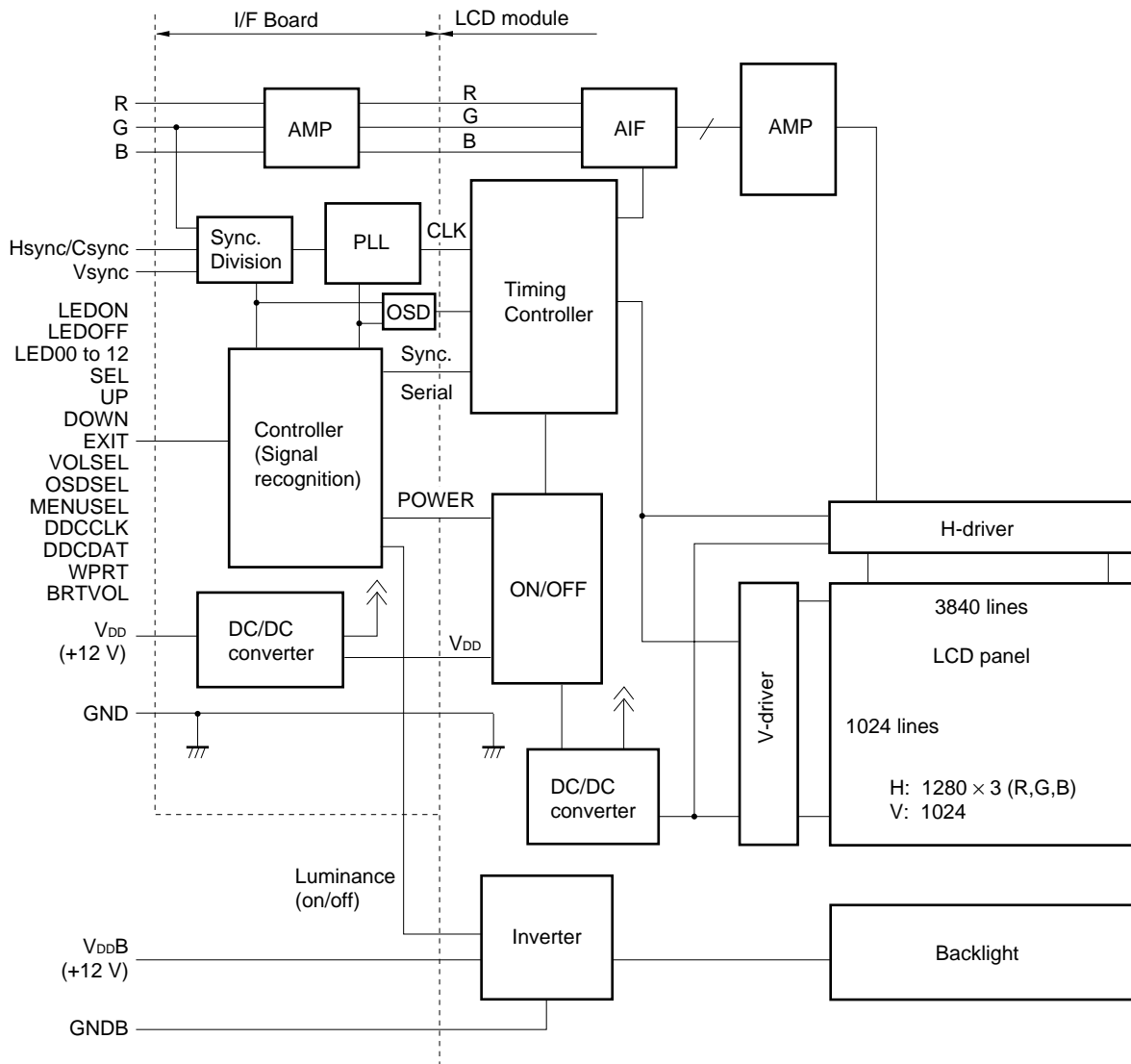

Note Neither GND nor GNDB is connected to Frame.

OUTLINE OF CHARACTERISTICS (at room temperature)

Display area	305.28 (H) × 244.224 (V) mm
Drive system	a-Si TFT active matrix
Display colors	Full-color
Number of pixels	1280 × 1024 pixels
Pixel arrangement	RGB vertical stripe
Pixel pitch	0.2385 (H) × 0.2385 (V) mm
Module size	350.0 (H) × 284.8 (V) × 26.0 (max.) (D) mm
Weight	1700 g (TYP.)
Contrast ratio	200 : 1 (TYP.)
Viewing angle (more than the contrast ratio of 10 : 1)	Horizontal : 60° (TYP., left side, right side) Vertical : 50° (TYP., up side), 45° (TYP., down side)
Color gamut	59% (TYP., at center, to NTSC)
Response time	7 ms (TYP.), white to black
Luminance	200 cd/m ² (TYP.)
Signal system	Analog RGB signals, Synchronous signals (Hsync and Vsync or Composite), CLK
Supply voltages	12 V (Logic/LCD driving), 12 V (Backlight)
Backlight	Edge light type: Four cold cathode fluorescent lamps with an inverter [Replaceable parts] <ul style="list-style-type: none">• Lamp holder: type No. 154LHS02• Inverter: type No. 154PW021
Power consumption	28.8 W (TYP.)

GENERAL SPECIFICATIONS

Item	Specification	Unit
Module size	350.0 ± 0.6 (H) × 284.8 ± 0.6 (V) × 26.0 (MAX.) (D)	mm
Display area	305.28 (H) × 244.224 (V)	mm
Number of dots	1280 × 3 (H) × 1024 (V)	dot
Number of pixels	1280 (H) × 1024 (V)	pixel
Dot pitch	0.0795 (H) × 0.2385 (V)	mm
Pixel pitch	0.2385 (H) × 0.2385 (V)	mm
Pixel arrangement	RGB (Red, Green, Blue) vertical stripe	–
Display colors	full color	color
Weight	1760 (MAX.)	g

ABSOLUTE MAXIMUM RATINGS

Parameter	Symbol	Rating	Unit	Remarks
Supply voltage	V _{DD}	–0.3 to +14	V	T _a = 25°C
	V _{DDB}	–0.3 to +14	V	
Logic input voltage	V _{IN1}	–0.3 to +5.5	V	T _a = 25°C V _{DD} = 12 V
R,G,B input voltage	V _{IN2}	–6.0 to +6.0	V	
CLK input voltage	V _{IN3}	–7.0 to +7.0	V	
Storage temp.	T _{ST}	–20 to +60	°C	–
Operating temp.	T _{OP}	0 to +50	°C	Module surface Note
Humidity	≤ 95% relative humidity		T _a ≤ 40°C	No condensation
	≤ 85% relative humidity		40 < T _a ≤ 50°C	
	Absolute humidity shall not exceed T _a = 50°C, 85% relative humidity level.		T _a > 50°C	

Note Measured at the LCD panel

ELECTRICAL CHARACTERISTICS

(1) Logic, LCD driving, Backlight

T_a = 25°C

Parameter	Symbol	MIN.	TYP.	MAX.	Unit	Remarks
Supply voltage	V _{DD} B	11.4	12.0	12.6	V	for backlight
	V _{DD}	11.4	12.0	12.6	V	for logic and LCD driving
Logic input Low voltage	V _{IL}	0	–	0.8	V	Hsync/Csync, Vsync, SEL, UP, DOWN, EXIT, VOLSEL, DDCDAT, DDCCLK, OSDSEL, WPRT, MENUSEL
Logic input High voltage	V _{IH}	2.0	–	5.25	V	
Logic output Low voltage	V _{OL}	–	–	0.4	V	DDCDAT
Logic output High voltage	V _{OH}	2.4	–	–	V	
Logic input Low current 1	I _{IL1}	–1	–	–	μA	Hsync/Csync, Vsync
Logic input High current 1	I _{IH1}	–	–	1	μA	
Logic input Low current 2	I _{IL2}	–	–	1	μA	DDCDAT
Logic input High current 2	I _{IH2}	–1	–	–	μA	
Supply current	I _{DD}	–	1000	1500	mA	for LCD driving V _{DD} = 12.0 V Note
		–	50	65	mA	Power saving mode, V _{DD} = 12.0 V Note
	I _{DD} B	–	1400	1600	mA	for back light V _{DD} B = 12.0 V
		–	1	10	mA	Power saving mode, V _{DD} B = 12.0 V

Note Pixel checkered pattern

(2) Video signal (R,G,B) input

T_a = 25°C

Item	MIN.	TYP.	MAX.	Unit	Remarks
Maximum amplitude (white - black)	0 (black)	0.7 (white)	*A	Vp-p	Need to adjust contrast if input more 0.7 Vp-p
DC input level (black)	–0.5	–	+2.5	V	–
Sync. level	0.2	0.3	*B	Vp-p	G terminal (Sync. On Green)
*A + *B	–	–	1.1	Vp-p	–

POWER SUPPLY DESIGN

- (1) Please note that the supply voltage must not be applied while the control signals (SEL, UP, DOWN, EXIT, BRT+ and BRT-) are connected to GND. Otherwise the module may cause malfunction.
- (2) If the power supply voltage is applied while UP and DOWN are connected to GND, the input control signals become ineffective. In this case, please turn off the power once and turn on the power while UP and DOWN are connected to GND again.
- (3) Inverter current wave
Inverter current wave is as follows.

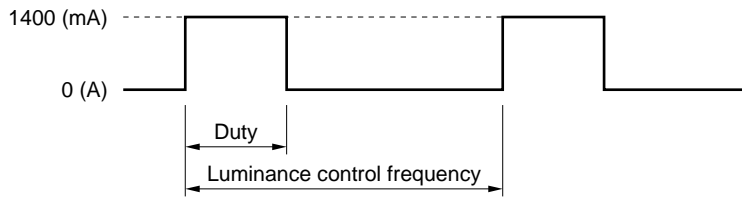

Maximum luminance control: 100%
 Minimum luminance control: 20%
 Luminance control frequency \approx Input Vsync frequency \times K
 Input Vsync frequency \leq 75 Hz: K = 4.6
 Input Vsync frequency $>$ 75 Hz: K = 3.6

(4) Ripple of supply voltage

	V _{DD} (for logic and LCD driver)	V _{DD} B (for backlight)
Acceptable range	\leq 100 mVp-p	\leq 200 mVp-p

Remark The acceptable range of ripple voltage includes spike noise.

Example of the power supply connection

a) Separate the power supply

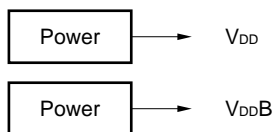

b) Put the filter

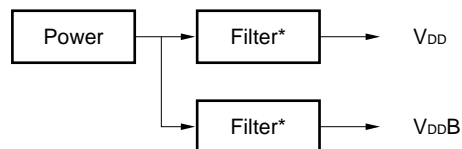

INTERFACE PIN CONNECTION

(1) Interface signals, power supply

CN101

Part No. : MRF03-6R-SMT

Adaptable socket : MRF03-6P-1.27 (For cable type) or MRF03-6PR-SMT (For board to board type)

Supplier : HIROSE ELECTRIC CO., LTD.

Pin No.	Symbol	Pin No.	Symbol
1	B	4	Vsync
2	G	5	Hsync/Csync
3	R	6 ▼	N.C. Note

Figure from socket view

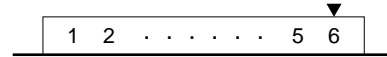

Note N.C. (No connection) should be open.

CN102

Part No. : IL-Z-4PL-SMTY

Adaptable socket : IL-Z-4S-S125C3

Supplier : Japan Aviation Electronics Industry Limited (JAE)

Pin No.	Symbol	Pin No.	Symbol
1	DDCCLK	3	MENUSEL
2	DDCDAT	4	GND

Figure from socket view

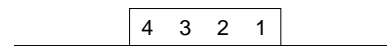

CN103

Part No. : DF14A-25P-1.25H

Adaptable socket : DF14-25S-1.25C

Supplier : HIROSE ELECTRIC CO., LTD. (coaxial type)

Pin No.	Symbol	Pin No.	Symbol
1	LEDON	14	EXIT
2	LEDOFF	15	GND
3	GND	16	BRTVOL
4	LED00	17	GND
5	LED01	18	VOLSEL
6	LED02	19	OSDSEL
7	LED10	20	WPRT
8	LED11	21	TEST1
9	LED12	22	TEST2
10	GND	23	GND
11	SEL	24	TEST3
12	UP	25	TEST4
13	DOWN		

Figure from socket view

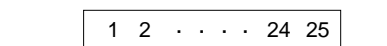

Note TEST1 to 4 should be open.

CN104

Part No. : IL-Z-8PL-SMTY

Adaptable socket : IL-Z-8S-S125C3

Supplier : Japan Aviation Electronics Industry Limited (JAE)

Pin No.	Symbol	Pin No.	Symbol
1	V _{DD}	5	GND
2	V _{DD}	6	GND
3	V _{DD}	7	GND
4	V _{DD}	8	GND

Figure from socket view

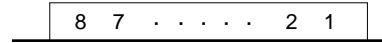

CN201

Part No. : IL-Z-11PL1-SMTY

Adaptable socket : IL-Z-11S-S125C3

Supplier : Japan Aviation Electronics Industry Limited (JAE)

Pin No.	Symbol	Pin No.	Symbol
1	V _{DD} B	7	N.C.
2	V _{DD} B	8	N.C.
3	V _{DD} B	9	N.C.
4	GNDB	10	N.C.
5	GNDB	11	N.C.
6	GNDB		

Figure from socket view



Note N.C. (No connection) should be open.

<Connector location>

Rear view

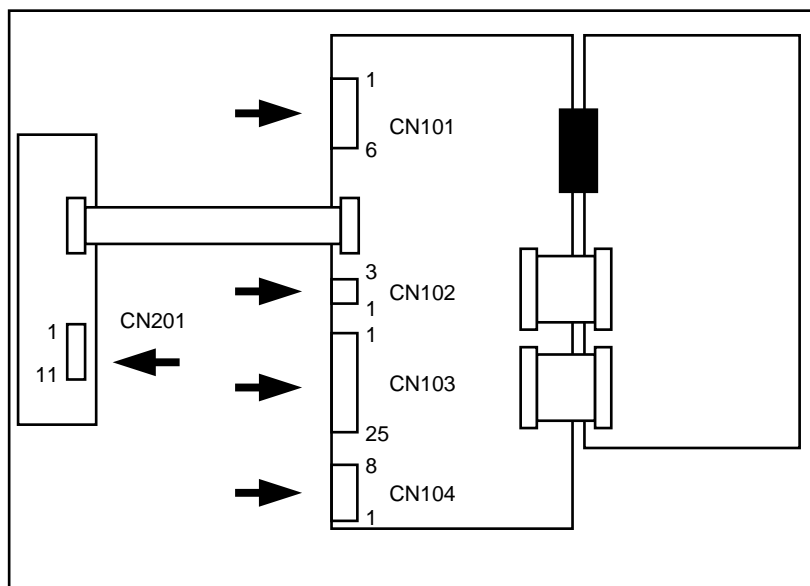

(2) Pin function

Symbol	I/O	Logic	Description
Hsync/ Csync	Input	Negative	Horizontal synchronous signal input or composite synchronous signal input (TTL level) , Positive/Negative auto recognition
Vsync	Input	Negative	Vertical synchronous signal input (TTL level) Positive/Negative auto recognition, Clock input for DDC1
R	Input	–	Red video signal input (0.7 Vp-p, 75 Ω)
G	Input	–	Green video signal input (0.7 Vp-p, 75 Ω)
B	Input	–	Blue video signal input (0.7 Vp-p, 75 Ω)
SEL	Input	Negative	Control function select signal (TTL level) SEL is pulled up in the module. Detail of the functions are mentioned in CONTROL FUNCTIONS . High or open: SEL off, Low: SEL on
UP	Input	Negative	Control signal (TTL level) The signal increases the value of the functions selected. UP is pulled up in the module. High or open: UP off, Low: UP on
DOWN	Input	Negative	Control signal (TTL level) The signal decreases the value of the functions selected. DOWN is pulled up in the module. High or open: DOWN off, Low : Down on
EXIT	Input	Negative	Control signal (TTL level) The signal initializes the selected function. EXIT is pulled up in the module. High or open: EXIT off, Low: EXIT on
OSDSEL	Input	–	Display select signal OSDSEL is pulled up in the module. “H or open”: OSD display off (light on LED) “L”: OSD display on (light off LED) Details of the functions are mentioned in CONTROL FUNCTIONS
MENUSEL	Input	–	OSD design select signal MENUSEL is pulled up in the module. “H or open”: OSD display No.2 “L”: OSD display No.1(Transparent background) Detail of the functions are mentioned in OSD DESIGN SELECT
BRTVOL	Input	–	Volume luminance control Detail of the functions are mentioned in LUMINANCE CONTROL SELECTION
VOLSEL	Input	–	Luminance control select signal VOLSEL is pulled up in the module. Details of the functions are mentioned in LUMINANCE CONTROL SELECTION
DDCCLK	Input	Positive	CLK for DDC2B
DDCDAT	Input/ Output	Positive	Data for DDC1/2B read/write
LEDON	Output	Positive	Indicator for LED power on “H”: LED select, “L”: Other status
LEDOFF	Output	Positive	Indicator for power save mode “H”: power save mode select, “L”: Other status

Symbol	I/O	Logic	Description
LED00	Output	Positive	See detail of EQUIVALENT CIRCUIT FOR LEDS and CONTROL FUNCTIONS
LED01	Output	Positive	
LED02	Output	Positive	
LED10	Output	Negative	
LED11	Output	Negative	
LED12	Output	Negative	
WPRT	Input	Positive	Select signal for DDC "open": Reading mode, "L": Writing mode
TEST1 to 4	Output	Positive	Reserve. TEST 1 to 4 should be open.
V _{DD}	-	-	Power supply for Logic and LCD driving +12 V (±5 %)
V _{DD} B	-	-	Power supply for backlight. +12 V (±5 %)
GND	-	-	Ground for system. Signal ground for logic/LCD driving
GNDB	-	-	Ground for backlight. GNDB is not connected to the module GND (FG).

Remark Frame ground, system ground and backlight ground are not connected into the module.

(3) LUMINANCE CONTROL SELECTION

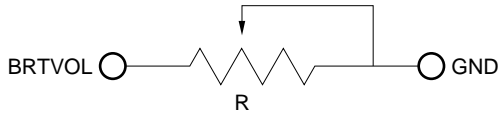
VOLSEL=	"L"	"Open"
Form	Digital adjust	Volume adjust
How to adjust	See CONTROL FUNCTIONS	<p>The variable resistor for luminance control should be 10 kΩ type, and zero point of the resistor corresponds to the minimum of luminance.</p>  <p>Maximum luminance (100%): R = 10 KΩ Minimum luminance (30%): R = 0 Ω Mating variable resistor: 10 KΩ ±5%, B curve, 1/10 W</p>

Note The status of VOLSEL is valid when the power is switched on.

(4) FUNCTION DISPLAY SELECT

OSDSEL=	"L"	"Open"
Form	OSD Display	LED Display
How to adjust	See CONTROL FUNCTIONS	See Example of LED circuit. (Next page)

Note The status of OSDSEL is valid when the power is switched on.

OSD

Regarding the use of OSD, please note that there is possibility of conflicts with a patent in Europe and the U.S. Thus, if such conflict might happen when you use OSD, we shall not be responsible for any trouble.

(5) OSD DESIGN SELECT

MENUSEL=	"L"	"Open"
Form	OSD display No. 1	OSD display No. 2
How to adjust	See CONTROL FUNCTIONS (OSD background is transparent)	See CONTROL FUNCTIONS

Note The status of MENUSEL is valid when the power is switched on.

(6) Equivalent circuit

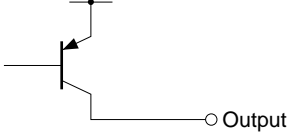
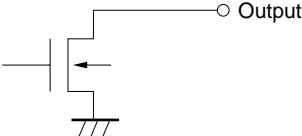
Symbol	I/O	Equivalent circuit
LEDON LEDOFF LED00 LED01 LED02	Output	RN2306 (Toshiba) or equivalent 
LED10 LED11 LED12	Output	N-ch Open Drain Output 

<Recommendation circuit diagram>

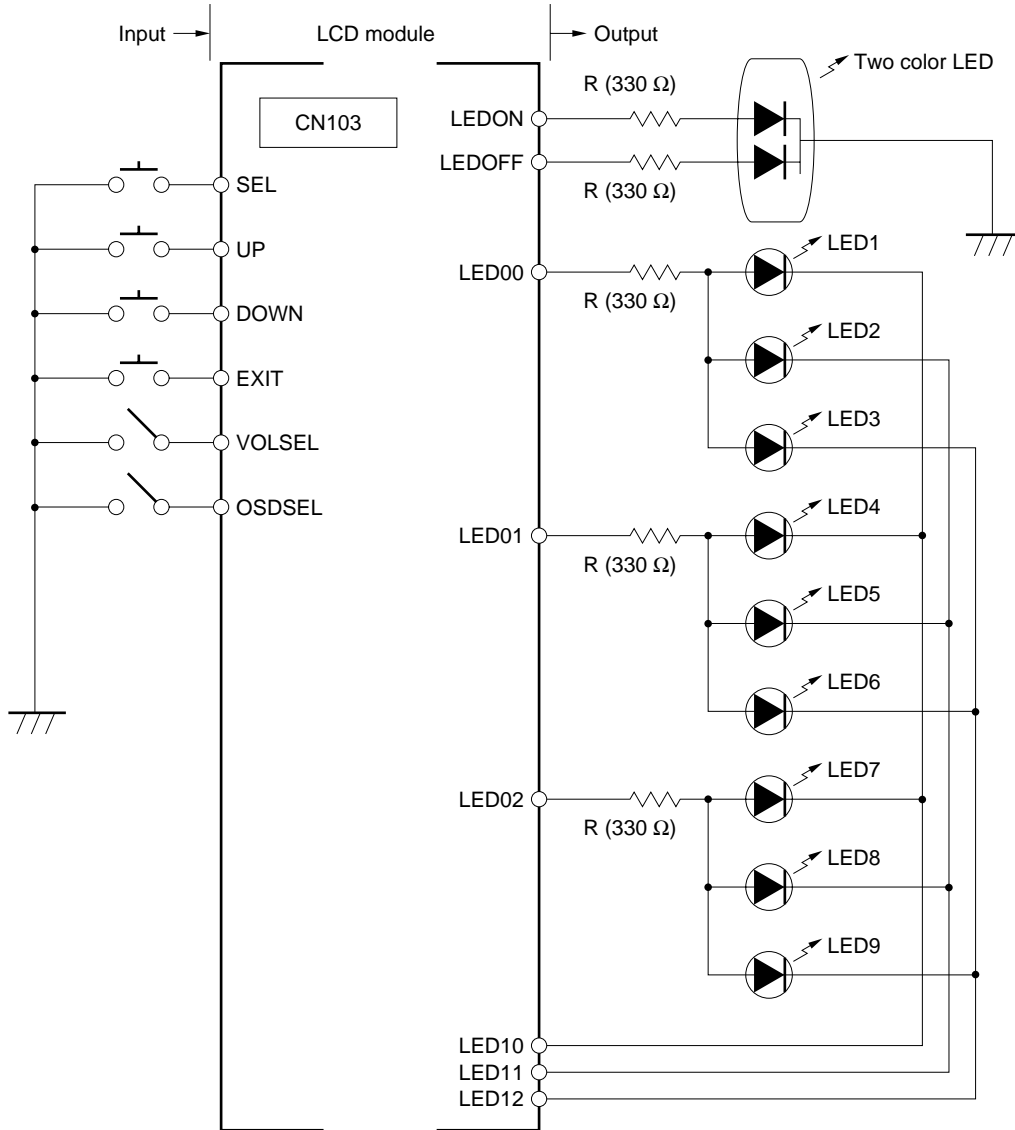

<LED status>

- LED1: Brightness
- LED2: Contrast
- LED3: Horizontal display period
- LED4: CLK delay
- LED5: Vertical position
- LED6: Horizontal position
- LED7: Reserve
- LED8: All reset
- LED9: Reserve

INPUT SYNCHRONOUS SIGNAL

This module can recognize the synchronous signals automatically as follows.

Auto recognition mode	Synchronous signal		
	HS/CS	Vsync	Sync. On Green
Separate synchronous signal mode (Hsync, Vsync)	Input	Input	Input or no input
Composite synchronous signal mode (CS)	Input (CS)	No input	Input or no input
Sync. On Green mode Note	No input	No input	Input
Power save mode	No input	No input	No input
	No input	Input	Input or no input
	Input (HS)	No input	Input or no input

CONTROL FUNCTIONS

FUNCTION ITEMS

(1) The function for OSD or LED

- 1. Brightness : Control luminance of backlight
- 2. Contrast : Control white-level of video signal
- 3. Horizontal display period : Adjust horizontal display period
- 4. CLK delay : Adjust CLK-phase
- 5. Vertical position : Adjust vertical position
- 6. Horizontal position : Adjust horizontal position
- 7. ALL RESET : Reset to factory-default value

(2) The function for OSD

- 1. Sub Brightness : Brightness with each video signal Control
- 2. Sub Contrast : white-level with each video signal Control
- 3. Video signal information : Display multi-scan function, Hsync and Vsync frequency

Each selected value is memorized into LCD memory after SEL signal input or time out. The memorized value is not affected even if the power is turned off. But the selected value is not memorized in case that a selected mode is changed another one before time out or power is turned off before time out.

Regarding the luminance, the luminance value can not be memorized while the variable volume resistor is selected.

This function does not work while the power save mode.

INDICATOR OF THE FUNCTIONS

The selected functions can be indicated either LED or OSD (On Screen Display) by setting OSDSEL signal.

OSDSEL = "H or "OPEN": LED
 OSDSEL = "L" : OSD

LED state show below table. Please see the recommendation circuit diagram.

Selection function	LED00	LED01	LED02	LED10	LED11	LED12
Default (no-select condition)	L	L	L	H	H	H
Brightness	H	L	L	L	H	H
Contrast	H	L	L	H	L	H
Horizontal display period	H	L	L	H	H	L
CLK delay	L	H	L	L	H	H
Vertical position	L	H	L	H	L	H
Horizontal position	L	H	L	H	H	L
Reserve (No use)	L	L	H	L	H	H
All reset	L	L	H	H	L	H
Reserve (no-use)	L	L	H	H	H	L

SELECTION BY OSD

The following pictures appear on the screen by pushing the SEL key. Adjust the each value in best position by pushing UP and DOWN key.

1) Menu



2) Brightness and Sub Brightness

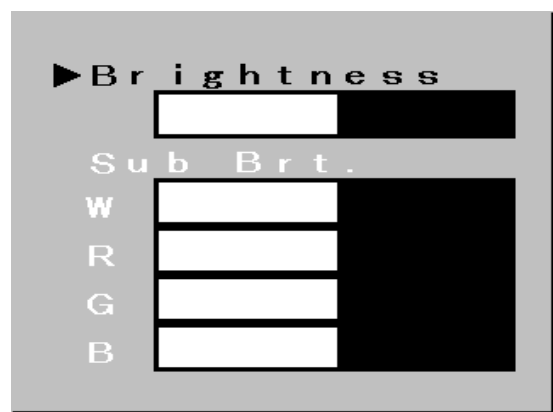

3) Contrast and Sub Contract

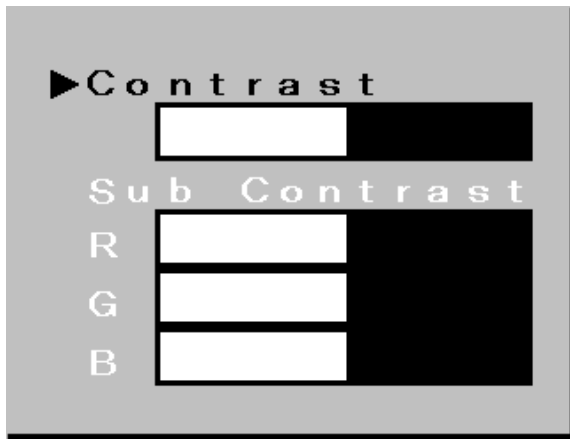

4) Horizontal display period, Clock delay, Vertical display position and Horizontal display position

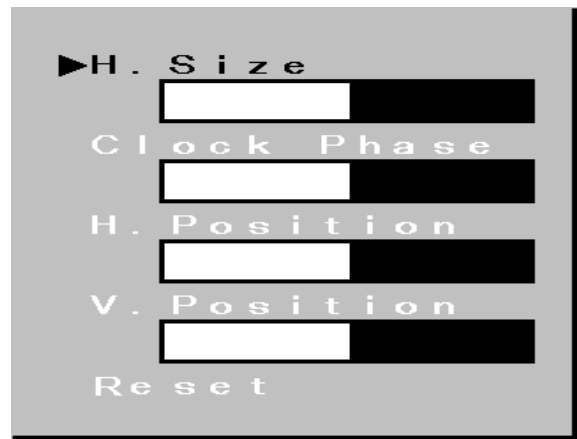

5) Information

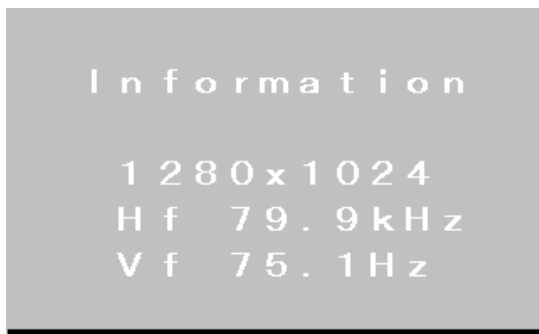

6) All Reset



FLOW CHART OF CONTROL FUNCTIONS FOR SEL, UP, DOWN AND EXIT

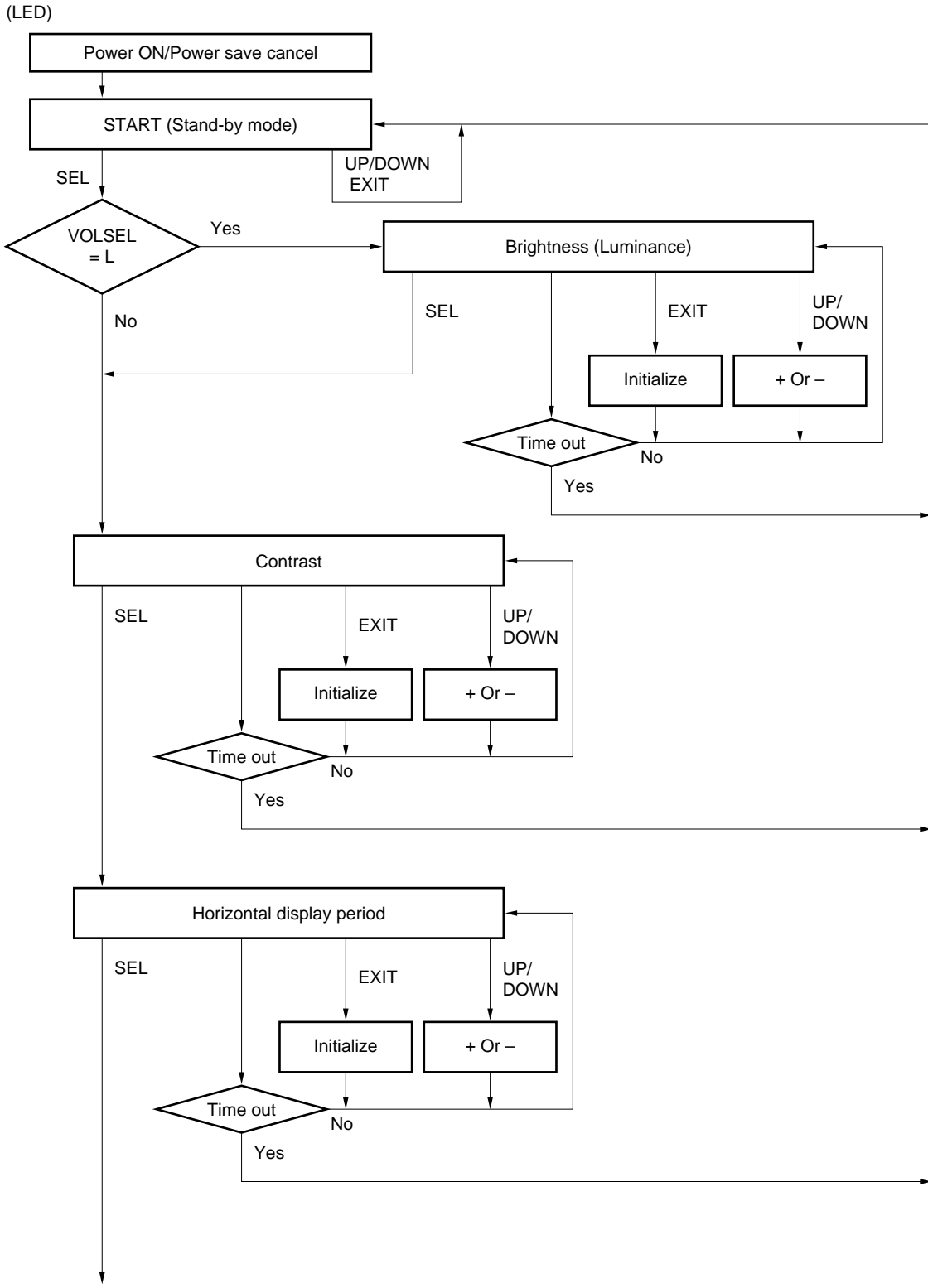

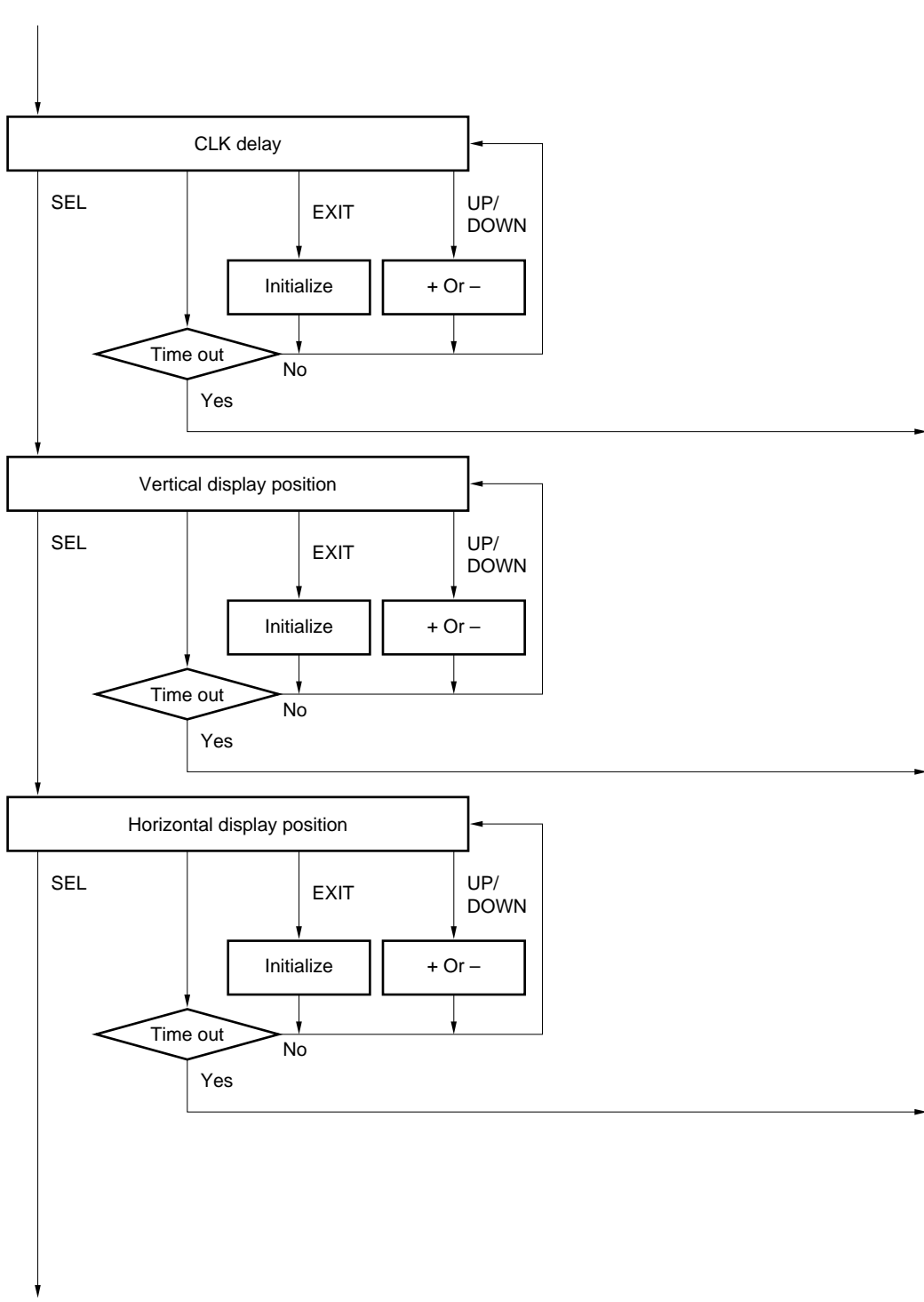

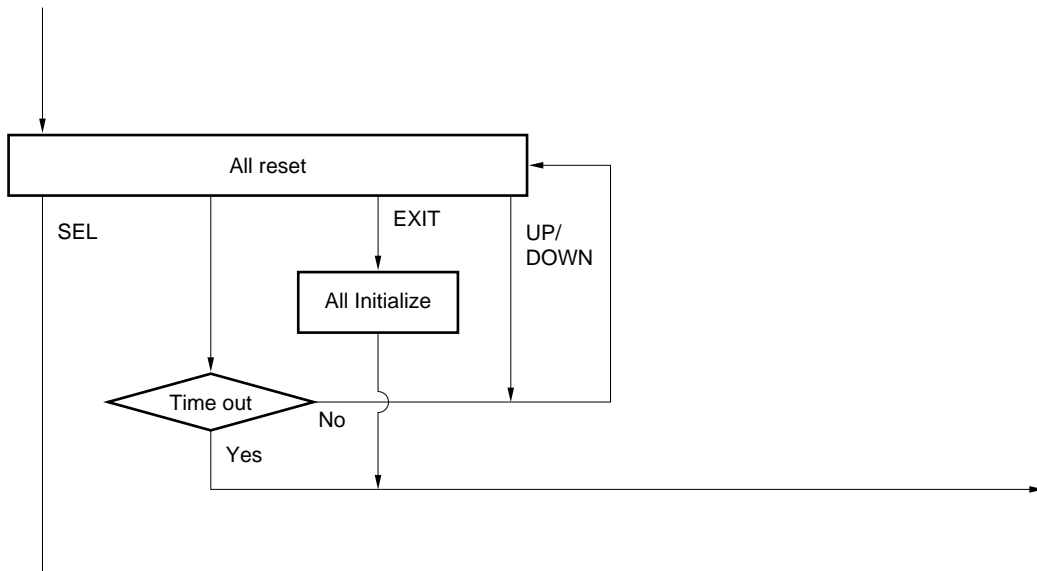

- Note**
1. The value of the selected signals by UP and DOWN key is continuously incremented if the input signal is held more than approx. one second. If it's less than one second, the value is incremented by one.
 2. EXIT signal initializes the value selected by SEL key. All reset function initializes all the values adjusted already.
 3. No key input for more than ten seconds shall be regarded "Time out".

<OSD display>

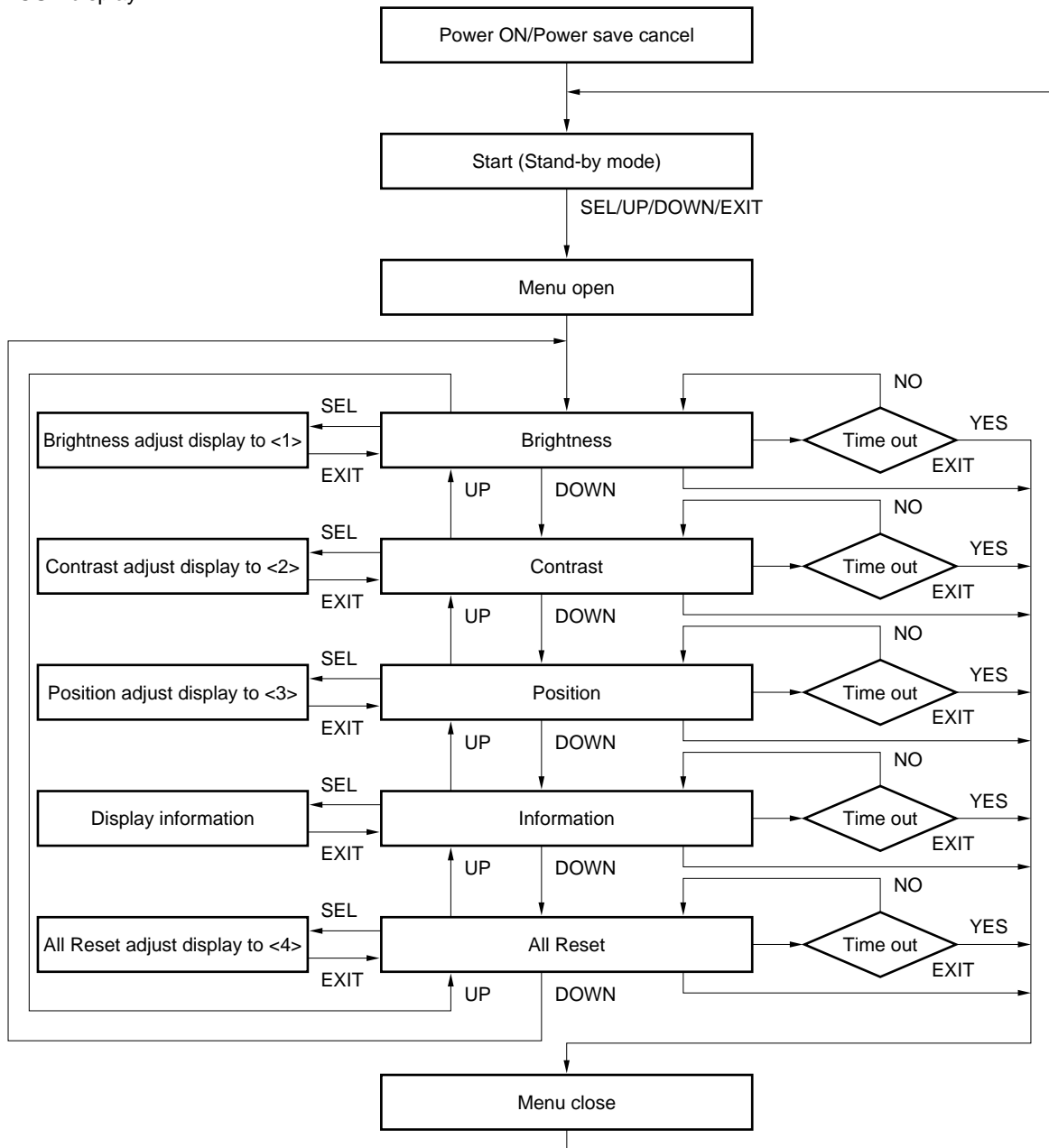

<Brightness adjustment>

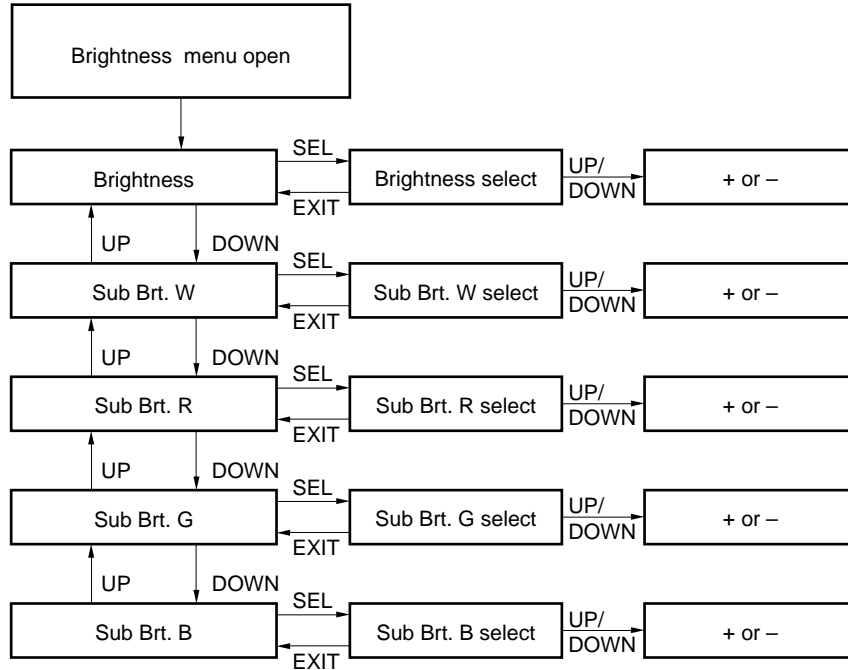

<Contrast adjustment>

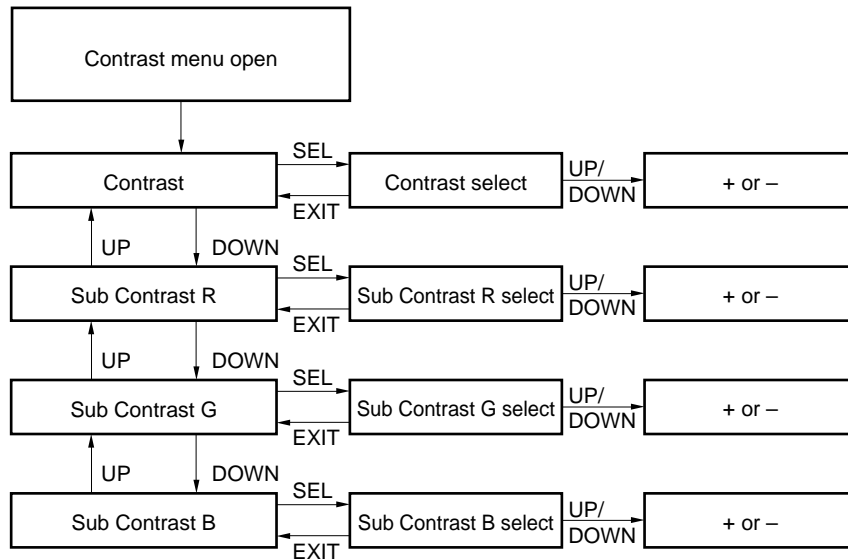

<Position adjustment>

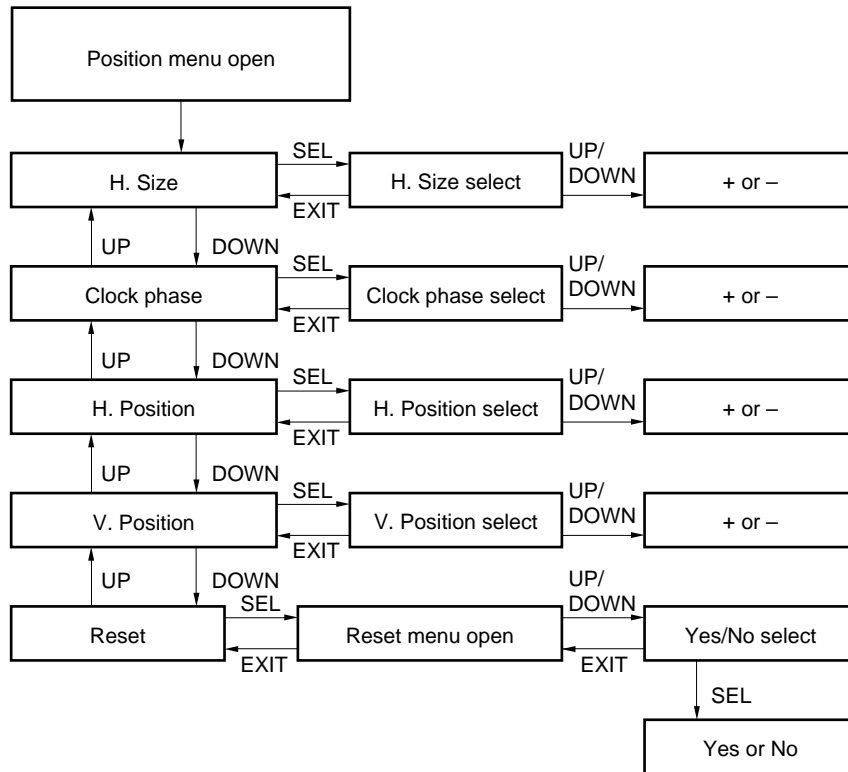

<All Reset>

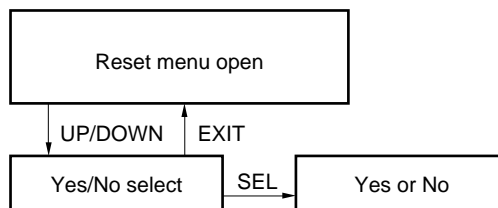

- Notes**
1. The value of the selected signals by UP and DOWN key is continuously incremented if the input signal is held more than approx. one second. If it's less than one second, the value is incremented by one.
 2. EXIT signal initializes the value selected by SEL key. All reset function initializes all the values adjusted already.
 3. No key input for more than ten seconds shall be regarded "Time out".

PRESET TIMINGNS

The 19 kinds of timings below are already programmed in this module. The input synchronous signals are automatically recognized.

No.	Display size	Vsync (Hz)	Hsync (kHz)	Dot CLK (MHz)	V Pulse (H)	V B. Porch (V)	H Pulse (DOTCLK)	H B. Porch (DOTCLK)	Sync Logic V, H	Remark
1	640 × 480	59.992	31.469	25.175	2	33	96	48	-, -	VGA
2	720 × 400	70.087	31.469	28.322	2	35	108	45	+, -	VGA TXT
3	800 × 600	60.317	37.879	40.000	4	23	128	88	+, +	VESA
4	640 × 480	66.667	35.000	30.240	3	39	64	96	SonG type A	Macintosh
5	640 × 480	75.000	37.500	31.500	3	16	64	120	-, -	VESA
6	720 × 400	85.039	37.927	35.500	3	42	36	144	+, -	VESA Note 1
7	640 × 480	85.008	43.269	36.000	3	25	48	112	-, -	VESA Note 1
8	1024 × 768	60.004	48.363	65.000	6	29	136	160	-, -	VESA
9	800 × 600	75.000	46.875	49.500	3	21	80	160	+, +	VESA
10	832 × 624	74.565	49.735	57.283	3	39	64	224	SonG type A	Macintosh
11	800 × 600	85.061	53.674	56.250	3	27	64	152	+, +	VESA Note 1
12	1024 × 768	70.069	56.476	75.000	6	29	136	144	-, -	VESA
13	1024 × 768	75.029	60.023	78.750	3	28	96	176	-, -	VESA
14	1280 × 1024	60.020	63.981	108.000	3	38	112	248	+, +	VESA
15	1152 × 900	60.003	61.846	94.500	4	31	128	208	CS(-)	SUN Note 1
16	1024 × 768	77.068	62.040	84.375	4	31	128	176	CS(-)	SUN Note 1
17	1280 × 1024	67.189	71.691	117.000	8	33	112	224	CS(-)	SUN
18	1152 × 900	76.149	71.809	108.000	8	33	128	192	CS(-)	SUN Note 1
19	1280 × 1024	75.025	79.976	135.000	3	38	144	248	+, +	VESA

Note 1. Out of specification. These modes are less display quality than other guaranteed modes.

Even if the preset timing is entered, a little adjustment of the functions such as Horizontal period, CLK-delay and display position, are required. The adjusted values are memorized in every preset No.

This module recognizes the synchronous signals with near preset timing of the frequency of Hsync, Vsync, even in the case that the signals other than the preset timing that were entered. For instance, it is displayed with presetting number 5 in the case of 640 × 480 dot, Hsync: 37.861 kHz, Vsync: 72.809 Hz an example).

Adopt the evaluation, because adjustment may not fit, in the case that the magnifying ratio differs, in the case that you use it with except for the display timing that was preset.

Note 2. Sync on Green signal type

(1) SonG type A

There are no Hsync pulses in Vsync Period.

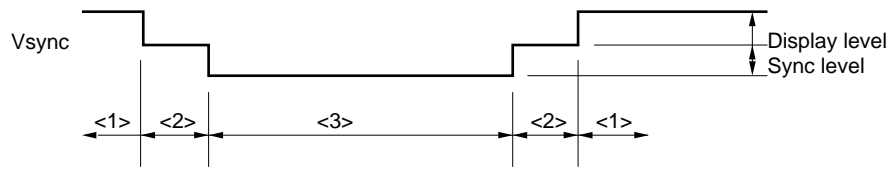

(2) SonG type B

There are Hsync pulses in Vsync Period.

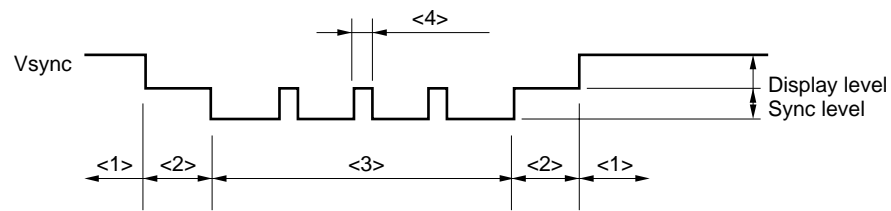

<1> Display level, <2> Black level period, <3> Vsync period, <4> Hsync pulse (equivalent)

DDC FUNCTION

The usage of this function is based on VESA™, DDC™ and EDID™.

- How to set up by WPRT signal
- Writing mode: WPRT = GND
- Reading mode: WPRT = Open

Remark All trademarks used within this document are the property of their respective owners. VESA, DDC, DPMS, and EDID are trademarks of the Video Electronics Standard Association.

In the writing mode, LEDON and LEDOFF signals output alternately “H” and “L”, and LEDs blink alternately.

Please write data into necessary addresses in advance, when you use this function. Data “55H” is set in the address “00H” when the module is shipped. The input equivalent circuit diagram is as follows.

[Internal circuit diagram]

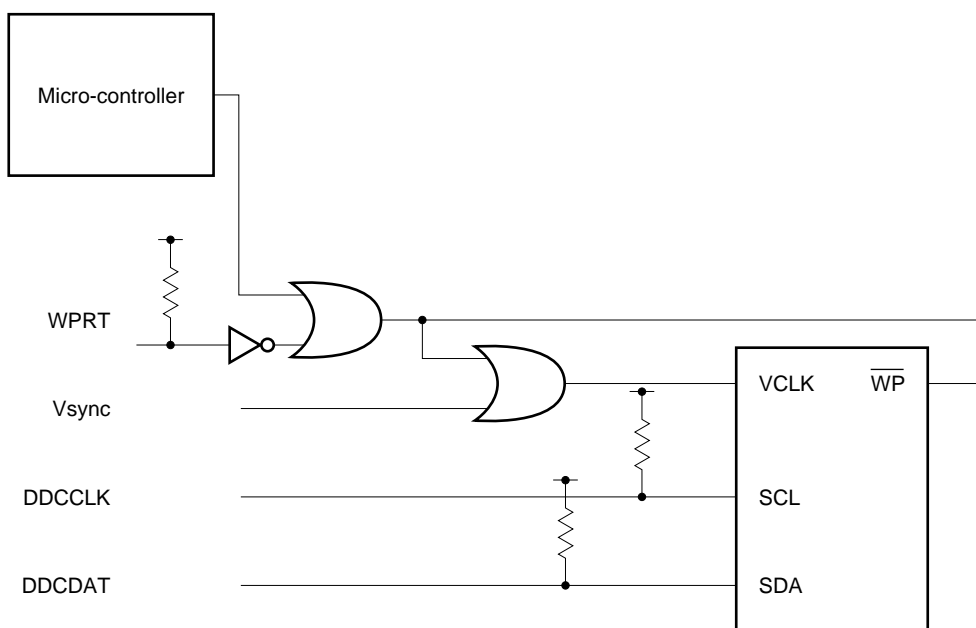

Product: Microchip Technology Inc.
24LCS21
or equivalent

DPMS

This function is corresponding to VESA DPMS™ Standard.

VESA DPMS Standard						NL128102AC23-02A	
State	Signal			Power saving	Recovery time	Power saving	Recovery time
	Horizontal	Vertical	Video				
On	Pulses	Pulses	Active	None	Not applicable	None	Not applicable
Stand-by	No pulses	Pulses	Blanked	Minimum	Short	Maximum	Short
Suspend	Pulses	No pulses	Blanked	Substantial	Longer	Maximum	Short
Off	No pulses	No pulses	Blanked	Maximum	System dependent	Maximum	Short

INPUT SIGNAL TIMING

(1) SXGA Mode (Standard)

Name		Symbol	MIN.	TYP.	MAX.	Unit	Remark
CLK	Frequency	1/tc	95.0 –	108.0 9.3	135.0 –	MHz ns	SXGA standard
	Rise/Fall	tcrf	–	–	10	ns	–
	Pulse-width	tc/tcl	0.4	0.5	0.6	–	–
Hsync	Period	th	12.3 –	15.630 1688	17.0 –	μs CLK	63.981 kHz (TYP.)
	Display	thd	– –	11.852 1280	– –	μs CLK	–
	Front-porch	thf	– 10	0.444 48	– –	μs CLK	–
	Pulse-width	thp	– 16	1.037 112	– –	μs CLK	–
	Back-porch	thb	1.0 94	2.296 248	– –	μs CLK	Note
	Pulse-width +Back-porch	thbp	1.8	–	–	μs	–
	V-Hsync hold/setup time	thvh	4	–	–	CLK	–
		thvs	1	–	–	CLK	–
Rise/Fall	thrf	–	–	10	ns	–	
Vsync	Period	tv	13.3 –	16.661 1066	18.5 –	ms H	60.020 Hz (TYP.)
	Display	tvd	– –	16.005 1024	– –	ms H	–
	Front-porch	tvf	– 1	0.016 1	– –	ms H	–
	Pulse-width	tvp	– 2	0.047 3	– –	ms H	–
	Back-porch	tvb	– 5	0.594 38	– –	ms H	–

Note Minimum value of Back-porch (thb) must be satisfied with both 1.0 μs and 44 CLK.

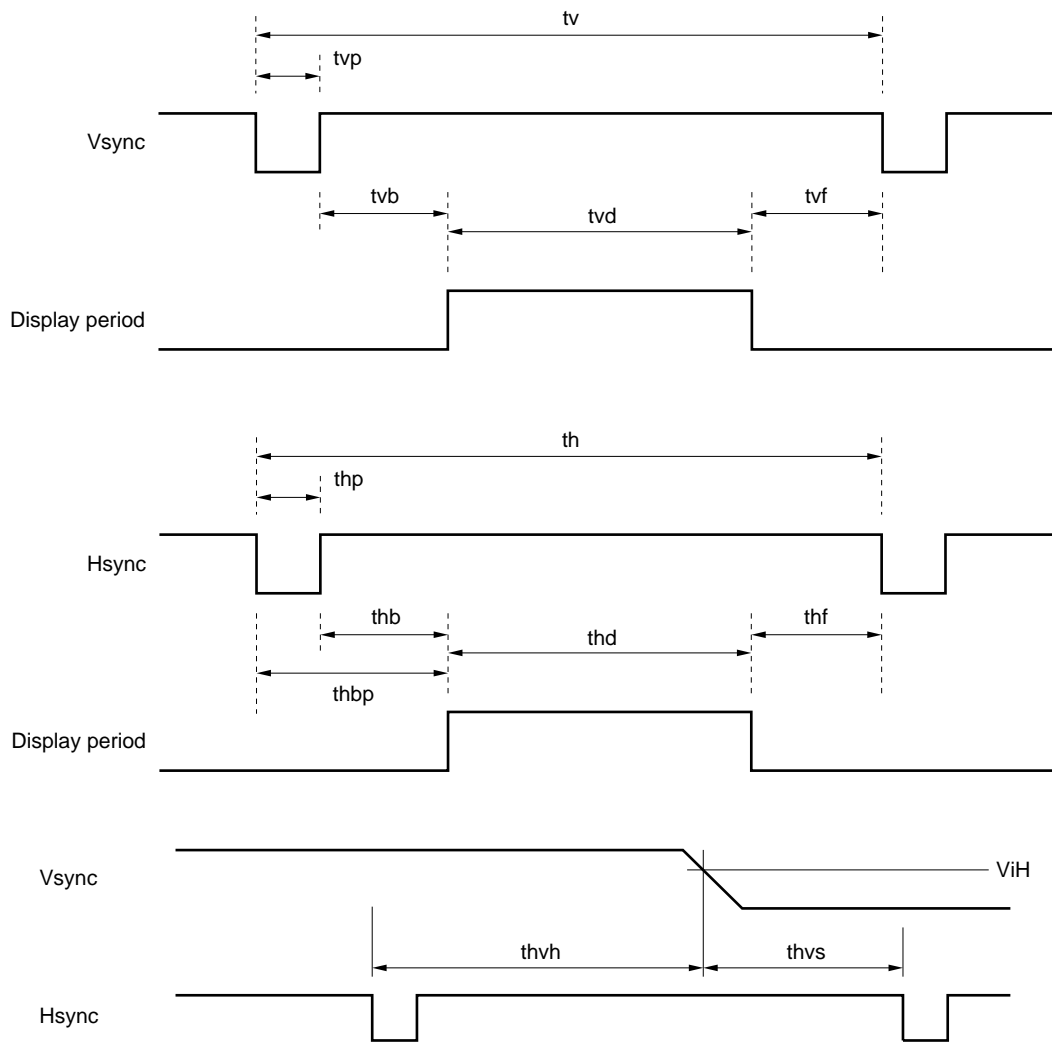

INPUT SIGNAL AND DISPLAY POSITION

(1) SXGA Standard Timing

Pixels

D (0, 0)	D (0, 1)	D (0, 2)	D (0, 1279)
D (1, 0)	D (1, 1)	D (1, 2)	D (1, 1279)
D (2, 0)	D (2, 1)	D (2, 2)	D (2, 1279)
.
.
.
.
D (1023, 0)	D (1023, 1)	D (1023, 2)	D (1023, 1279)

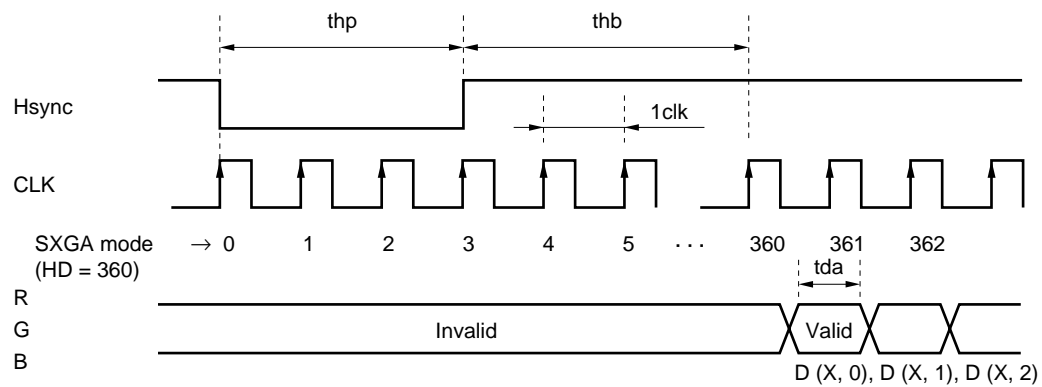
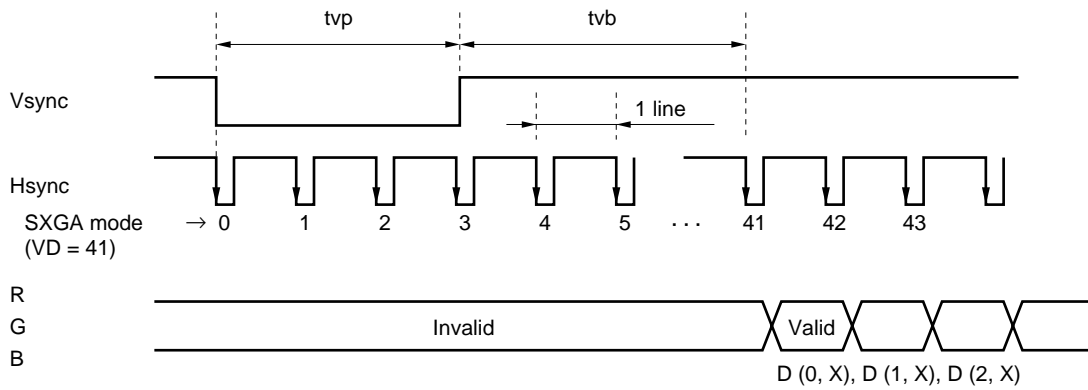

Remark The tda should be more than 4 ns.

EXPANSION FUNCTION (REFERENCE)

(1) How to use expansion mode

Expansion mode is a function to expand screen. For example, VGA signal has 640 × 480 pixels. But, if the display data can be expanded to 2.0 times vertically and horizontally, VGA screen image can be displayed fully on the screen of SXGA resolution.

This LCD module has the function that expands vertical direction as shown in the following table. And expanding horizontal direction is possible by setting input CLK frequency equivalent to the magnification. It is necessary to make this CLK outside of this LCD module.

Please adopt this mode after evaluating display quality, because the appearance in the expansion mode is happened to be relatively bad in some cases.

The followings show the display magnifications for each mode.

Input display	Number of pixels	Magnification	
		Vertical	Horizontal Note
SXGA	1280 × 1024	1	1
XGA	1024 × 768	1.25	1.25
SVGA	800 × 600	1.6	1.6
VGA	640 × 480	2.0	2.0
VGA text	720 × 400	2.5	1.7
MAC	832 × 624	1.6	1.5

Note The horizontal magnification multiplies the input clock (CLK).

Input CLK = system CLK × horizontal magnification.

Example In case of SXGA and VGA, CLK frequency can be decided as follows.

SXGA: (system CLK (108.0 MHz)) × 1.0 = 108.0 MHz.

VGA : (system CLK (25.175 MHz)) × 2.0 = 50.35 MHz.

(2) Setting serial data for expansion

Input signal								Module serial-data setting		
Mode	System CLK [MHz]	Hsync [kHz]	Vsync [Hz]	Horizontal		Vertical		HSE	HD	VD
				Count Number [CLK]	DSP [CLK]	Count Number [H]	DSP [H]	Calculation formula		
				(A)	(B)	-	(C)	(A) × Ver.magni	(B) × Hor.magni	= (C)
SXGA (1280 × 1024)	108.0	63.981	60.02	1688	360	1066	41	(A) × 1	(B) × 1	= (C)
	117.0	71.691	67.189	1632	336	1067	41			
	125.0	75.120	71.204	1664	352	1055	28			
	130.076	76.968	72.000	1690	378	1069	42			
	135.0	78.125	72.005	1728	384	1085	58			
XGA (1024 × 768)	65*	48.363	60.004	1344	296	806	35	(A) × 1.25	(B) × 1.25	= (C)
	75*	56.476	70.069	1328	280	806	35			
	78.75*	60.023	75.029	1312	272	800	31			
MAC (832 × 624)	57.283*	49.725	74.5	1152	288	667	42	(A) × 1.5	(B) × 1.5	= (C)
SVGA (800 × 600)	36*	35.156	56.25	1024	200	625	24	(A) × 1.6	(B) × 1.6	= (C)
	40*	37.879	60.317	1056	216	628	27			
	50*	48.077	72.188	1040	184	666	29			
	49.5*	46.875	75	1056	240	666	24			
VGA (640 × 480)	25.175*	31.469	59.94	800	144	525	35	(A) × 2.0	(B) × 2.0	= (C)
	31.5*	37.861	72.809	832	168	520	31			
	31.5*	37.5	75	840	184	500	19			
	30.24*	35.0	66.667	864	160	525	42			
VGA text (720 × 400)	28.322*	31.469	70.087	900	153	449	37	(A) × 1.7	(B) × 1.7	= (C)
SUN (1152 × 900)	94.500*	61.845	66.003	1528	336	937	35	(A) × 1.1	(A) × 1.1	= (C)

*: Standard timings (Please set them up properly for correct expansion).

- Note**
1. DSP = Display Start Period. DSP is total of "pulse-width" and "back-porch".
 2. HD and VD are approximate value. Set HD and VD in case of adjusting display to the screen center.
 3. The pulse-width of Hsync, Vsync and Back-porch are the same as SXGA-mode (Standard-mode).

(3) Display Image

1. XGA mode (1024 × 768)

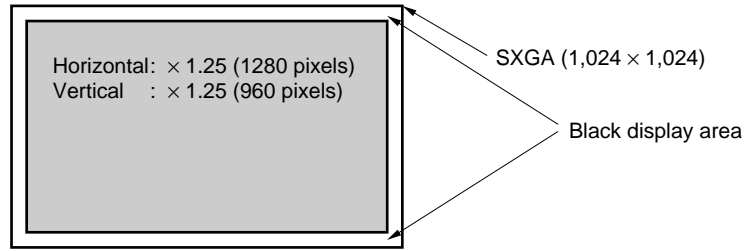

2. SVGA mode (800 × 600)

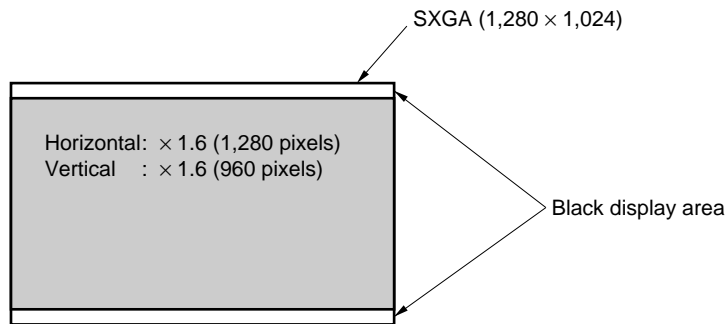

3. VGA mode (640 × 480)

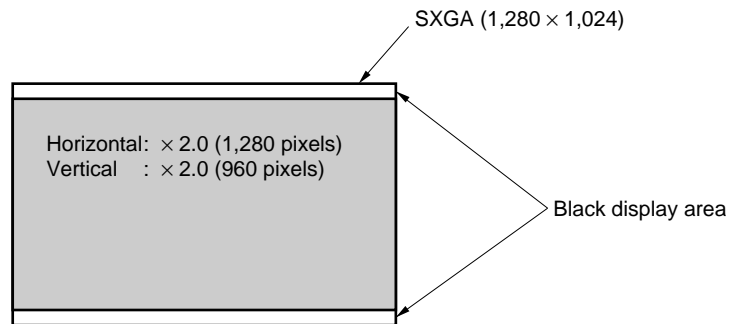

4. VGA text mode (720 × 400)

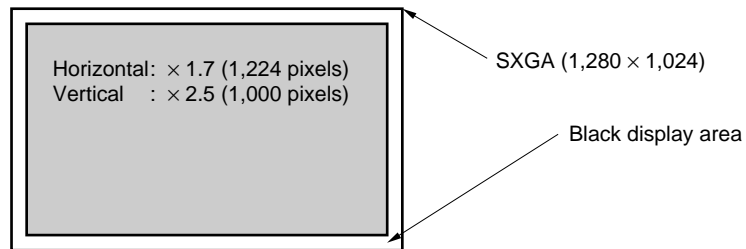

5. 832 × 624 MAC mode (832 × 624)

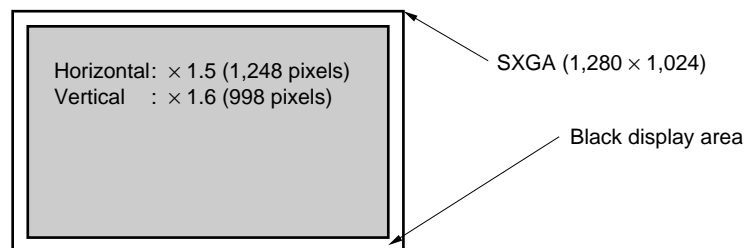

6. SUN mode (1152 × 900)

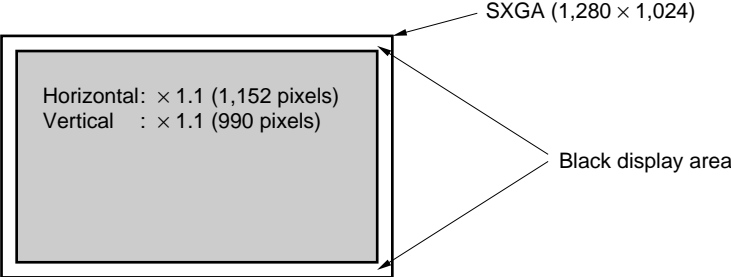

OPTICAL CHARACTERISTICS

(T_a = 25°C, V_{DD} = 12 V, V_{DD}B = 12 V)

Item	Symbol	Condition	Min.	Typ.	Max.	Unit	Remark
Luminance	Lvmax	White	150	200	–	cd/m ²	Note 1
Contrast ratio	CR	White/Black, at center	100	200	–	–	Note 2
Luminance uniformity	–	White	–	1.20	1.30	–	Note 3

Reference data

(T_a = 25°C, V_{DD} = 12 V, V_{DD}B = 12 V)

Item	Symbol	Condition	Min.	Typ.	Max.	Unit	Remark
Viewing angle range	θR	CR > 10, θU = 0°, θD = 0°	50	60	–	deg.	Note 4
	θL		50	60	–	deg.	
	θU	CR > 10, θR = 0°, θL = 0°	35	50	–	deg.	
	θD		30	45	–	deg.	
Color gamut	C	θR = 0°, θL = 0°, θU = 0°, θD = 0°, at center, to NTSC	50	59	–	%	–
Response time	Ton	White to Black	–	7	12	ms	Note 5
	Toff	Black to White	–	37	55	ms	
Luminance control range	–	Maximum luminance: 100 %	–	30 to 100	–	%	–

- Notes** 1. The luminance is measured after 20 minutes from the module works, with all pixels in white. Typical value is measured after luminance saturation.
 Display mode: VESA SXGA - 75 Hz

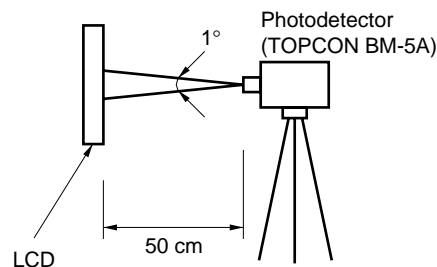

2. The contrast ratio is calculated by using the following formula.

$$\text{Contrast ratio (CR)} = \frac{\text{Luminance with all pixels in "white"}}{\text{Luminance with all pixels in "black"}}$$

The Luminance is measured in darkroom.

3. The luminance is measured at near the five points shown below.

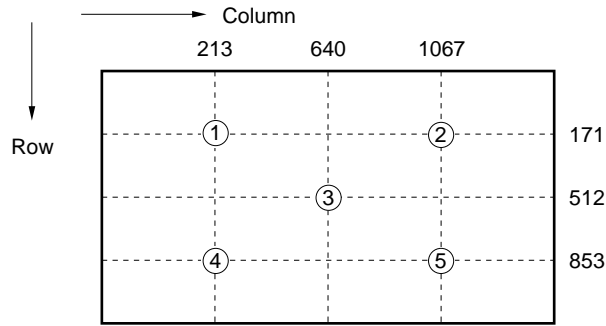

4. Definitions of viewing angle are as follows.

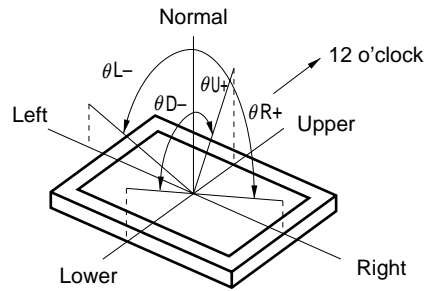

5. Definition of response time is as follows.

Photo-detector output signal is measured when the luminance changes “white” to “black”.

Response times are T_{on} and T_{off} of the photo-detector output amplitude. T_{on} is the time between 100 % and 10 %. T_{off} is the time between 0 % and 90 %.

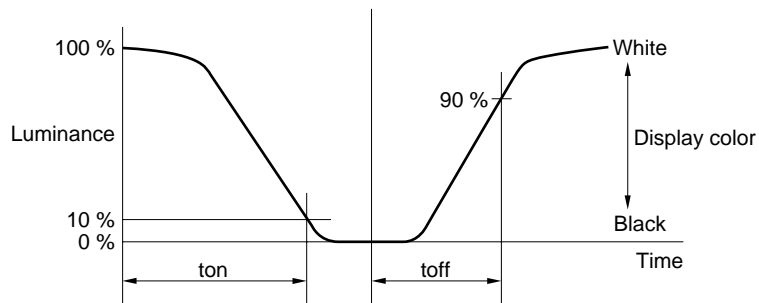

RELIABILITY TEST

Test item		Test condition
High temperature/humidity operation	Note 1	50 ± 2°C, 85% relative humidity 240 hours Display data is black.
Heat cycle (operation)	Note 1	<1> 0°C ± 3°C ... 1 hour 55°C ± 3°C ... 1 hour <2> 50 cycles, 4 hours/cycle <3> Display data is black.
Thermal shock (non-operation)	Note 1	<1> -20°C ± 3°C ... 30 minutes 60°C ± 3°C ... 30 minutes <2> 100 cycles <3> Temperature transition time within 5 minutes
Vibration (non-operation)	Notes 1, 2	<1> 5 - 100 Hz, 2G 1 minute/cycle X, Y, Z direction <2> 50 times each direction
Mechanical shock (non-operation)	Notes 1, 2	<1> 30 G, 11 ms X, Y, Z direction <2> 3 times each direction
ESD (operation)	Notes 1, 3	150 pF, 150 Ω, ±10 kV 9 places on a panel 10 times each place at one-second intervals
Dust (operation)	Note 1	15 kinds of dust (JIS Z 8901) Hourly 15 seconds stir, 8 times repeat

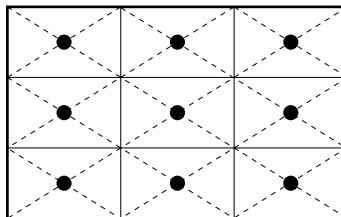

- Notes**
1. Display function is checked by the same condition as LCD module out-going inspection.
 2. Physical damage.
 3. Discharge points “●” are shown in the figure.



GENERAL CAUTIONS

Next figures and sentence are very important. Please understand these contents as follows.

	CAUTION This figure is a mark that you will get hurt and/or the module will have damages when you make a mistake to operate.
---	--

	This figure is a mark that you will get an electric shock when you make a mistake to operate.
	This figure is a mark that you will get hurt when you make a mistake to operate



	Do not touch an inverter, on which is stuck a caution label, while the LCD module is under the operation, because of dangerous high voltage.
---	--

(1) Caution when taking out the module

- a) Pick the pouch only, in taking out module from a carrier box.

(2) Cautions for handling the module

- a) As the electrostatic discharges may break the LCD module, handle the LCD module with care against electrostatic discharges.
- b)  As the LCD panel and backlight element are made from fragile glass material, impulse and pressure to the LCD module should be avoided.
- c) As the surface of polarizer is very soft and easily scratched, use a soft dry cloth without chemicals for cleaning.
- d) Do not pull the interface connectors in or out while the LCD module is operating.
- e) Put the module display side down on that horizontal plane.
- f) Handle connectors and cables with care.
- g) When the module is operating, do not lose CLK, Hsync or Vsync signal. If any one of these signals is lost, the LCD panel would be damaged.
- h) The torque to mounting screw should never exceed 0.392 N·m (4 kgf·cm).

(3) Cautions for the atmosphere

- a) Dew drop atmosphere should be avoided.
- b) Do not store and/or operate the LCD module in a high temperature and/or high humidity atmosphere. Storage in an electro-conductive polymer packing pouch and under relatively low temperature atmosphere is recommended.
- c) This module uses cold cathod fluorescent lamps. Therefore, the life time of lamps becomes short conspicuously at low temperature.
- d) Do not operate the LCD module in a high magnetic field.

(4) Caution for the module characteristics

- a) Do not apply fixed pattern data signal for a long time to the LCD module at product aging. Applying fixed pattern for a long time may cause image sticking.

(5) Other cautions

- a) Do not disassemble and/or reassemble LCD module.
- b) Do not readjust variable resistors or switches, etc.
- c) When returning the module for repair or etc, please pack the module not to be broken. We recommend to the original shipping packages.

Liquid Crystal Display has the following specific characteristics. There are not defects or malfunctions.

- The display condition of LCD module may be affected by the ambient temperature.
- The LCD module uses cold cathode tube for backlighting. Optical characteristics, like luminance or uniformity, will change during time.
- Uneven brightness and/or small spots may be noticed depending on different display patterns.

OUTLINE DRAWING: Front View (Unit: mm)

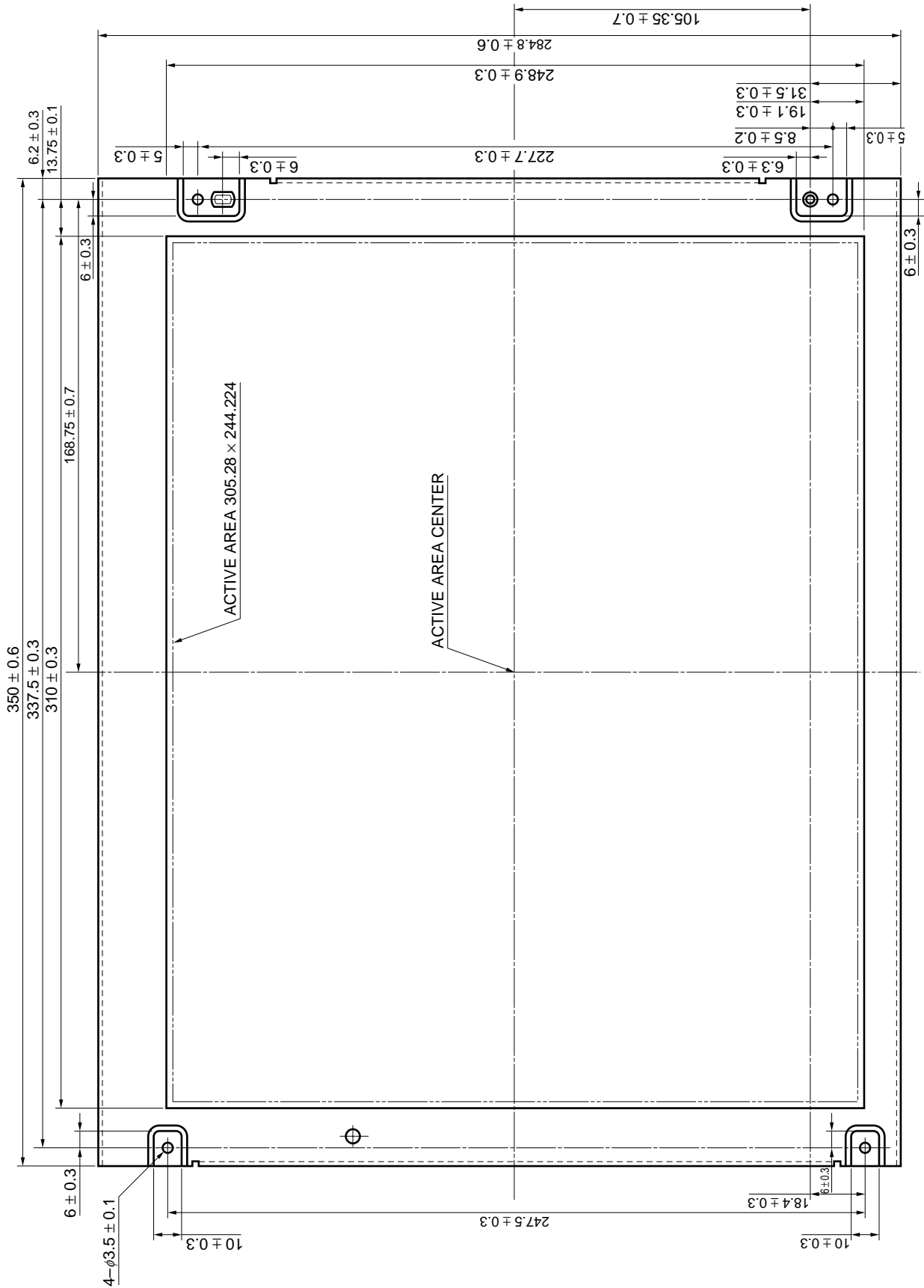

Remark The torque to mounting screw should never exceed $0.392 \cdot \text{Nm}$ ($4 \text{ kgf} \cdot \text{cm}$).

OUTLINE DRAWING: Rear View (Unit: mm)

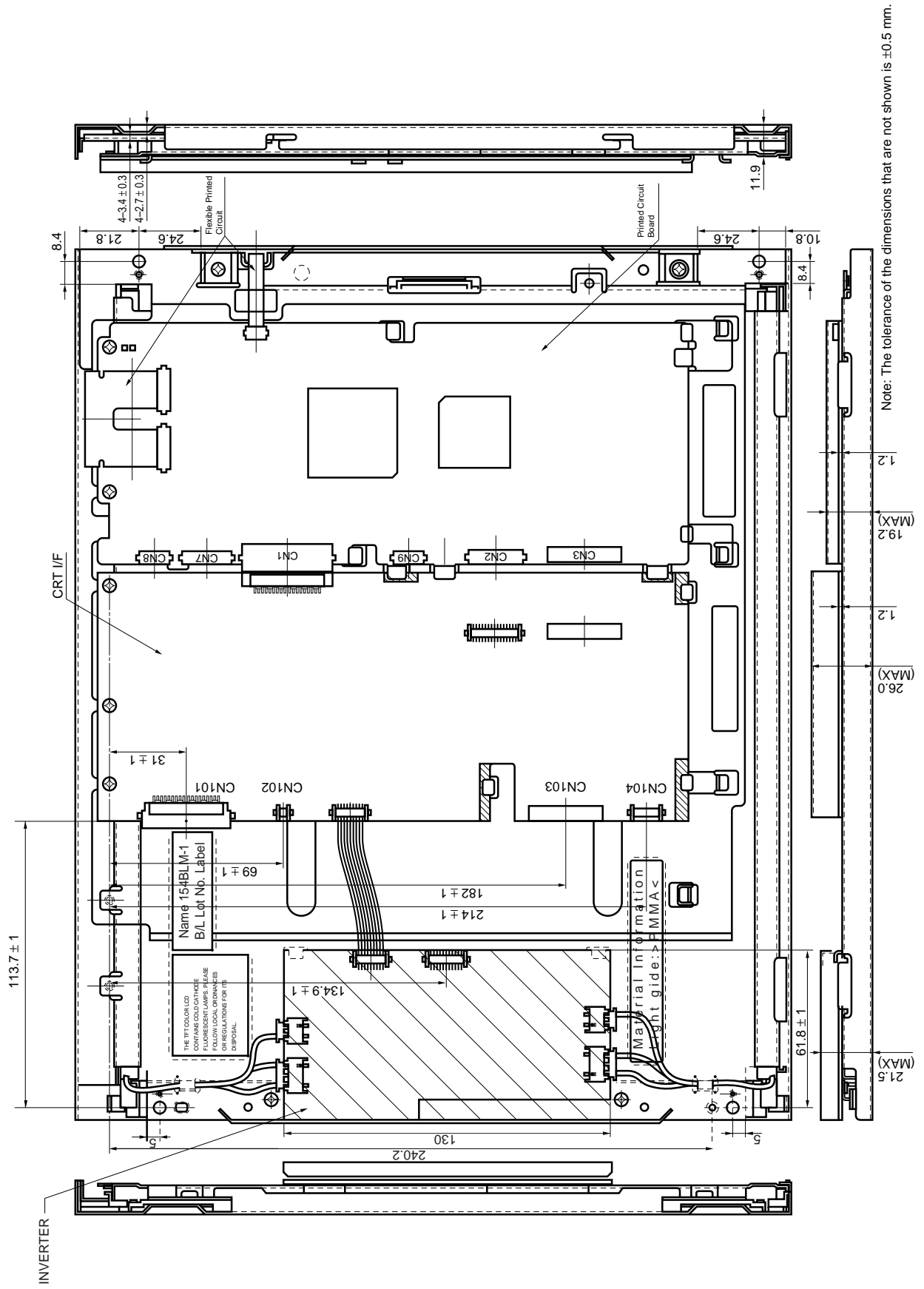

Remark The torque to mounting screw should never exceed 0.392 · Nm (4 kgf · cm).

[MEMO]

No part of this document may be copied or reproduced in any form or by any means without the prior written consent of NEC Corporation. NEC Corporation assumes no responsibility for any errors which may appear in this document.

NEC Corporation does not assume any liability for infringement of patents. Copyrights or other intellectual property rights of third parties by or arising from use of a device described herein or any other liability arising from use of such device. No license, either express, implied or otherwise, is granted under any patents, copyrights or other intellectual property rights of NEC Corporation or others.

While NEC Corporation has been making continuous effort to enhance the reliability of its Electronic Components, the possibility of defects cannot be eliminated entirely. To minimize risks of damage or injury to persons or property arising from a defect in an NEC Electronic Components, customers must incorporate sufficient safety measures in its design, such as redundancy, fire-containment, and anti-failure features.

NEC devices are classified into the following three quality grades:

“Standard”, “Special”, and “Specific”. The Specific quality grade applies only to devices developed based on a customer designated “quality assurance program” for a specific application. The recommended applications of a device depend on its quality grade, as indicated below. Customers must check the quality grade of each device before using it in a particular application.

Standard: Computers, office equipment, communications equipment, test and measurement equipment, audio and visual equipment, home electronic appliances, machine tools, personal electronic equipment and industrial robots

Special: Transportation equipment (automobiles, trains, ships, etc.), traffic control systems, anti-disaster systems, anti-crime systems, safety equipment and medical equipment (not specifically designed for life support)

Specific: Aircrafts, aerospace equipment, submersible repeaters, nuclear reactor control systems, life support systems or medical equipment for life support, etc.

The quality grade of NEC devices is “Standard” unless otherwise specified in NEC’s Data Sheets or Data Books. If customers intend to use NEC devices for applications other than those specified for Standard quality grade, they should contact an NEC sales representative in advance.

Anti-radioactive design is not implemented in this product.