

# NEC

液晶之友 电话: 020-33819057  
[Http://www.lcdfriends.com](http://www.lcdfriends.com)

## TFT COLOR LCD MODULE

Type: NL128102AC28-04  
 46cm (18.1 Type), SXGA

### SPECIFICATIONS

(First Edition)

## PRELIMINARY

This document is preliminary. All information in this document is subject to change without prior notice.

NEC Corporation Display Device Operations Unit Color LCD Division Application Engineering Department		
Approved	<i>U. Fuku</i>	Oct. 27, 1999
Checked	<i>/</i>	Oct. 27, 1999
Prepared	<i>y. Okuda</i>	Oct. 27, 1999

No part of this document may be copied or reproduced in any form or by any means without the prior written consent of NEC Corporation. NEC Corporation assumes no responsibility for any errors, which may appear in this document.

NEC Corporation does not assume any reliability for infringement of patents, copyrights or other intellectual property rights of third parties by or arising from use of a device described herein or any other liability arising from use of such device. No license, either express, implied or otherwise, is granted under any patents, copyrights or other intellectual property rights of NEC Corporation or others.

The devices listed in this document are not suitable for use of aerospace equipment, submarine cables, nuclear reactor control systems and life support systems. If customers intend to use NEC devices for above applications or they intend to use "Standard" quality grade NEC devices for applications not intended by NEC, please contact our sales people in advance.

**Application examples recommended by NEC Corporation**

**Standard:** Computer, Office equipment, Communication equipment, Test and Measurement equipment,  
Machine tools, Industrial robots, Audio and Visual equipment, Other consumer products, etc.

**Special:** Automotive and Transportation equipment, Traffic control systems, Antidisaster systems,  
Anticrime systems, etc.

## CONTENTS

1. DESCRIPTION .....	P.4
2. FEATURES .....	P.4
3. APPLICATIONS .....	P.4
4. STRUCTURE AND FUNCTIONS .....	P.4
5. OUTLINE OF CHARACTERISTICS (at room temperature) .....	P.5
6. BLOCK DIAGRAM .....	P.6
7. GENERAL SPECIFICATIONS .....	P.7
8. ABSOLUTE MAXIMUM RATINGS .....	P.7
9. ELECTRICAL CHARACTERISTICS .....	P.7
10. SUPPLY VOLTAGE SEQUENCE .....	P.9
11. INTERFACE PIN CONNECTIONS .....	P.10
12. METHOD OF CONNECTIONS FOR THC63LVDF63A .....	P.15
13. DISPLAY COLORS vs INPUT DATA SIGNALS .....	P.16
14. INPUT SIGNAL TIMINGS .....	P.17
15. OPTICAL CHARACTERISTICS .....	P.21
16. RELIABILITY TEST .....	P.24
17. EXPECTED LIFE-TIME OF THE LAMP .....	P.24
18. GENERAL CAUTIONS .....	P.25
19. OUTLINE DRAWINGS .....	P.27
19.1 FRONT VIEW .....	P.27
19.2 REAR VIEW .....	P.28

## 1. DESCRIPTION

NL128102AC28-04 is a TFT (thin film transistor) active matrix color liquid crystal display (LCD) comprising amorphous silicon TFT attached to each signal electrode, a driving circuit and a backlight. NL128102AC28-04 has a built-in backlight with inverter.

The 46cm(18.1 Type) diagonal display area contains  $1280 \times 1024$  pixels and can display 16,777,216 colors simultaneously.

## 2. FEATURES

- Ultra-wide viewing angle and low reflection
- LVDS interface (THC63LVDF84A x 2pcs, THine Electronics, Inc.)
- High luminance and Low reflection
- Incorporated direct type backlight ( Eight lamps in a lamp unit, Inverter)
- Lamp unit replaceable (Part No. : 181LHS02)

## 3. APPLICATIONS

- Engineering work station, Desk-top type of PCs
- Display terminals for control systems
- Monitors for process controller

## 4. STRUCTURE AND FUNCTIONS

A color TFT (thin film transistor) LCD module is comprised of a TFT liquid crystal panel structure, LSIs for driving the TFT array, and a backlight assembly. Sandwiching liquid crystal material in the narrow gap between a TFT array glass substrate and a color filter glass substrate creates the TFT panel structure. After the driver LSIs are connected to the panel, the backlight assembly is attached to the backside of the panel.

RGB (red, green, blue) data signals from a source system is modulated into a form suitable for active matrix addressing by the onboard signal processor and sent to the driver LSIs, which in turn addresses the individual TFT, cells.

Acting as an Electro-optical switch, each TFT cell regulates light transmission from the backlight assembly when activated by the data source. By regulating the amount of light passing through the array of red, green, and blue dots, color images are created with clarity.

### 5. OUTLINE OF CHARACTERISTICS (at room temperature)

Display area	359.04 (H) × 287.232 (V) mm
Drive system	a-Si TFT active matrix
Display colors	16,777,216 colors
Number of pixels	1280 × 1024
Pixel arrangement	RGB vertical stripe
Pixel pitch	0.2805(H) × 0.2805(V)mm
Module size	424.0(H) × 337.0(V) × 40.0 max.(D) mm
Weight	1910 g (typ.)
Contrast ratio	400:1 (typ.)
Viewing angle (more than the contrast ratio of 10:1)	<ul style="list-style-type: none"> <li>· Horizontal: 85 ° (typ. , left side, right side)</li> <li>· Vertical: 85 ° (typ. , up side, down side)</li> </ul>
Designed viewing direction	<ul style="list-style-type: none"> <li>· Optimum grayscale ( <math>\gamma = 2.2</math> ): perpendicular</li> </ul>
Polarizer Pencil-hardness	3 H(min., at JIS K5400)
Color gamut	60 %(typ. At center, To NTSC)
Response time	45 ms(typ.), "black" to "white"
Luminance	200 cd/m <sup>2</sup> (typ.)
Signal system	RGB 8-bit signals, Synchronous signals(Hsync, Vsync), DE 2 ports LVDS interface (THC63LVDF84A x 2pcs, THine Electronics, Inc.)
Supply voltage	12V (Logic, LCD driving) , 12V ( Backlight)
Backlight	Direct light type: Eight cold cathode fluorescent lamps with inverter 【Replaceable parts】 <ul style="list-style-type: none"> <li>· Lamp holder unit Parts No.: 181LHS02</li> <li>· Inverter Parts No.: 181PW021</li> </ul>
Power consumption	42.6 W (typ.)

6. BLOCK DIAGRAM

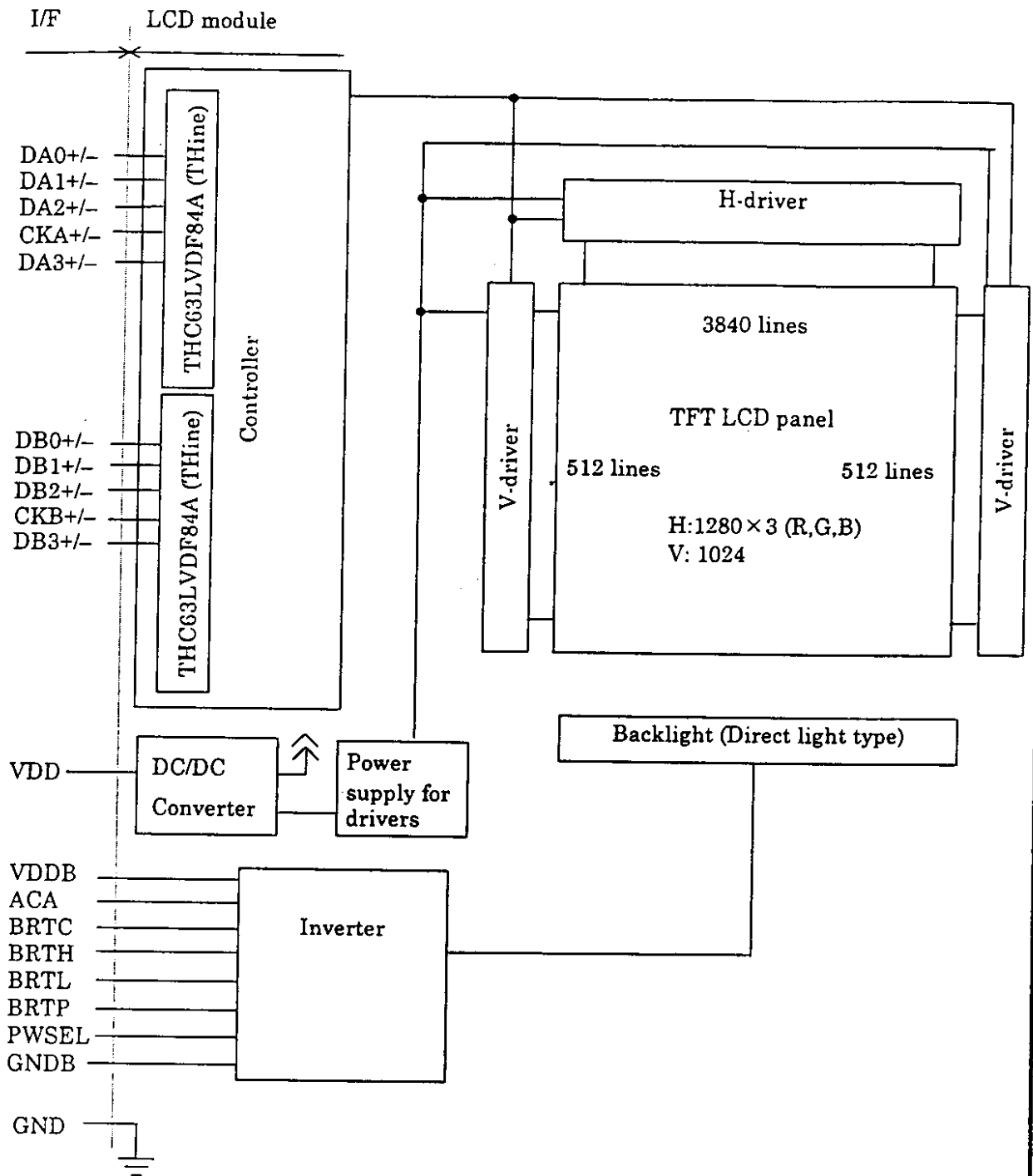

Note 1: Neither GND nor GNDB connected to FG (Frame Ground) in this LCD module.  
GND and GNDB should be connected to FG in customer equipment.

## 7. GENERAL SPECIFICATIONS

Items	Specifications	Unit
Module size	424.0±1.0 (H) × 337.0±1.0 (V) × 40.0(max.)(D)	mm
Display area	359.04 (H) × 287.232 (V)	mm
Number of pixels	1280 (H) × 1024 (V)	pixel
Dot pitch	0.0935 (H) × 0.2805 (V)	mm
Pixel pitch	0.2805 (H) × 0.2805 (V)	mm
Pixel arrangement	RGB (Red, Green, Blue) vertical stripe	—
Display colors	16,777,216 (RGB, 8bit)	color
Weight	(2100) (max.)	g

## 8. ABSOLUTE MAXIMUM RATINGS

Parameters	Symbols	Ratings	Unit	Remarks
Supply voltage	VDD	-0.3 to +14.0	V	Ta = 25°C
	VDDDB	-0.3 to +14.0	V	
Logic input voltage	Vi	-0.3 to 3.6	V	
Logic input voltage (backlight-logic signal)	ViBL1	-0.3 to +5.5	V	
Logic input voltage (backlight-BRTL signal)	ViBL2	-0.3 to +1.5	V	
Storage temperature	Tst	-20 to +60	°C	—
Operating temperature	Top	0 to +55	°C	Module surface Note 1
Relative humidity (RH)	Note 2	≤ 95	%	Ta ≤ 40°C
		≤ 70	%	40°C < Ta ≤ 55°C
Absolute humidity	Note 2	Absolute humidity shall not exceed Ta=55°C, RH=70% level.		Ta > 55°C

Note 1: Measured at the display area (including self heat)

Note 2: No condensation

## 9. ELECTRICAL CHARACTERISTICS

## (1) Logic/ LCD driving

Ta = 25°C

Parameters	Symbols	Min.	Typ.	Max.	Unit	Remarks
Supply voltage	VDD	11.4	12.0	12.6	V	—
Ripple voltage	Vrp	—	—	100	mV	for VCC
LVDS signal input "L" voltage	ViL	-100	—	—	mV	VCM=1.2V VCM: Common mode voltage in LVDS driver
LVDS signal input "H" voltage	ViH	—	—	+100	mV	
Input voltage width	Vi	—	—	2.4	V	—
Common mode voltage	VCM	1.125	1.25	1.375	V	Rt=100Ω
Terminating resistor	Rt	—	100	—	Ω	—
Supply current	IDD	—	(350) Note 1	(1000)	mA	VDD=12.0V

Note 1: Checker flag pattern (in EIAJ ED-2522)

## (2) Backlight

Ta = 25°C

Parameters	Symbols	Min.	Typ.	Max.	Unit	Remarks
Supply voltage	VDDDB	11.4	12.0	12.6	V	—
Logic input "L" voltage	ViL1	0	—	0.6	V	for BRTP
Logic input "H" voltage	ViH1	2.2	—	5.25	V	
Logic input "L" voltage	ViL2	0	—	0.8	V	for BRTP, ACA, BRTL
Logic input "H" voltage	ViH2	2.2	—	5.25	V	
Logic input "L" current	IiL	-1580	—	—	μA	for BRTP
Logic input "H" current	IiH	—	—	3500	μA	
Logic input "L" current	IiL	-810	—	—	μA	for BRTP, ACA, PWSEL
Logic input "H" current	IiH	—	—	440	μA	
Supply current	IDDB	—	(3200)	(3500)	mA	VDDDB=12.0V (at max. luminance)

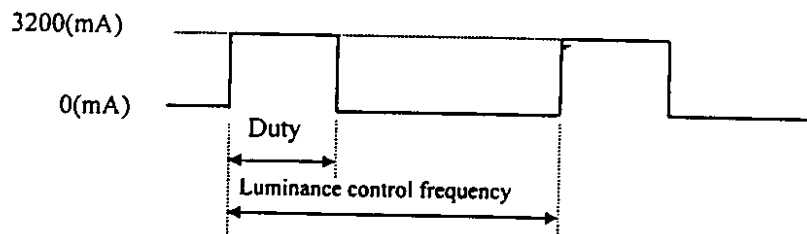

maximum luminance control : 100%

minimum luminance control : 20%

Luminance control frequency : 237 to 273 Hz    255Hz(typ.)

## (3) Fuse

Supply voltage	Part No.	Supplier	Ratings	Remarks
VDD	CCP2E40	KOA	1.6A	-
VDDDB	R429005	Littel fuse	5A	-

## (4) Ripple of supply voltage

Supply voltage	VDD (for logic and LCD driver)	VDDDB (for backlight)
Acceptable range	$\leq 100\text{mVp-p}$	$\leq 200\text{mVp-p}$

note 1: The acceptable range of ripple voltage includes spike noise.

Example of the power supply connection

a) Separate the power supply

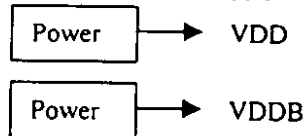

b) Put the filter

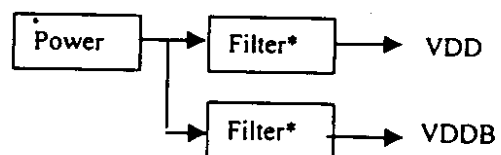

Filter\* (reference value)

L = 10 μH to 100 μH

C = 10 μF to 100 μF



## 10. SUPPLY VOLTAGE SEQUENCE

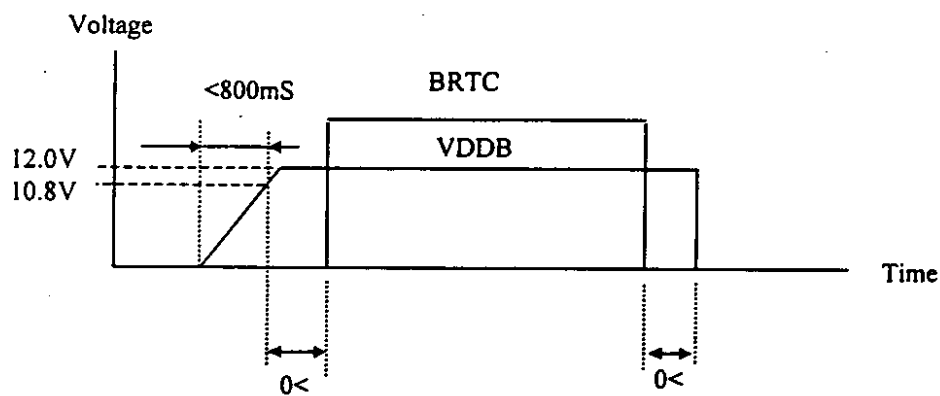
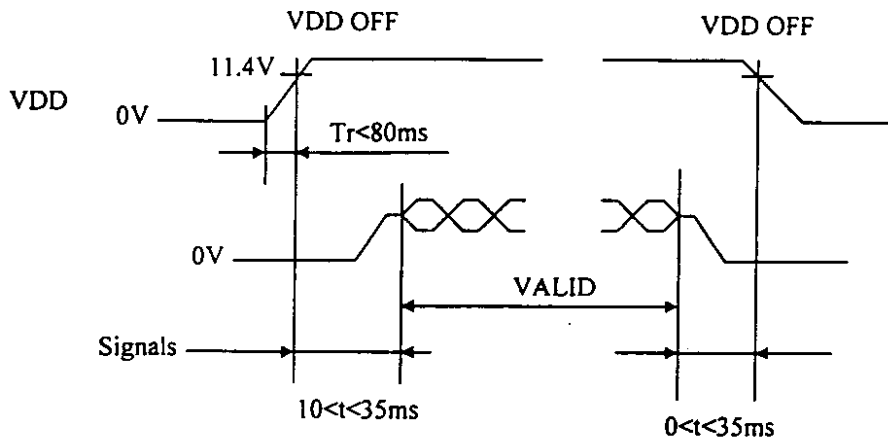

- \*1 Logic signals (synchronous signals and control signals) must be "0" voltage (V), when VDD is not input. If input voltage to signal lines is higher than 0.3 V, the internal circuit will be damaged.
- \*2 The supply voltage for input signals should be the same as VDD.
- \*3 The backlight ON/OFF (BRTC signal) should be controlled while logic signals are supplied. The backlight power supply (VDDB) is not related to the power supply sequence. However, unstable data will be displayed when the backlight power is turned ON with no logic signals
- \*4 12V for backlight should be started up within 800ms, otherwise, the protection circuit makes the backlight turn off.
- \*5 The backlight is turned off with safety circuit, when "L" period of BRTP signal is input more than 50 ms.
- \*6 Do not input "H" ACA and PWSEL, when VDDB is 0V or BRTC is "L".

## 11. INTERFACE PIN CONNECTIONS

(1) Interface connector for signal and power

CN1

Part No. : 53780-2010  
 Adaptable socket : 51146-2000  
 Supplier : Molex Incorporated.

Pin No.	Symbols	Signal type	Function
1	N.C.	N.C.	Keep the terminal open
2	N.C.		
3	GND	Ground	Connect to system ground
4	GND		
5	DA0-	Odd pixel Data0	Odd pixel data input0 (LVDS level)
6	DA0+		
7	GND	Ground	Connect to system ground
8	DA1-	Odd pixel Data1	Odd pixel data input1 (LVDS level)
9	DA1+		
10	GND	Ground	Connect to system ground
11	DA2-	Odd pixel Data2	Odd pixel data input2 (LVDS level)
12	DA2+		
13	GND	Ground	Connect to system ground
14	CKA-	Odd pixel Clock	Odd pixel clock input (LVDS level)
15	CKA+		
16	GND	Ground	Connect to system ground
17	DA3-	Odd pixel Data3	Odd pixel data input3 (LVDS level)
18	DA3+		
19	GND	Ground	Connect to system ground
20	N.C.	N.C.	Keep the terminal open

\* N.C. means "non connection"

Note 1: GND is signal ground for logic and LCD driving. GND should be connected to system ground. GND is not connected to FG (Frame Ground) in this LCD module.

Note 2: Connect all pins (except 1,2) to avoid noise issue. Use 100Ω twist pair wires for the Cable.

CN1: Figure from socket view

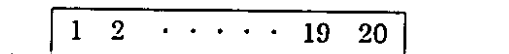

CN2

Part No. : 53780-3010  
 Adaptable socket : 51146-3000  
 Supplier : Molex Incorporated.

Pin No.	Symbols	Signal type	Function
1	N.C.	N.C.	Keep the terminal open
2	N.C.		
3	GND	Ground	Connect to system ground
4	GND		
5	DB0-	Even Pixel Data0	Even pixel data input0 (LVDS level)
6	DB0+		
7	GND	Ground	Connect to system ground
8	DB1-	Even Pixel Data1	Even pixel data input1 (LVDS level)
9	DB1+		
10	GND	Ground	Connect to system ground
11	DB2-	Even Pixel Data2	Even pixel data input2 (LVDS level)
12	DB2+		
13	GND	Ground	Connect to system ground
14	CKB-	Even Pixel Clock	Even pixel clock input (LVDS level)
15	CKB+		
16	GND	Ground	Connect to system ground
17	DB3-	Even Pixel Data3	Even pixel data input3 (LVDS level)
18	DB3+		
19	GND	Ground	Connect to system ground
20	Res.	Res.	Keep the terminal open
21	Res.		
22	Res.		
23	Res.		
24	GND	Ground	Connect to system ground
25	GND		
26	GND		
27	N.C.	N.C.	Keep the terminal open
28	VDD	+12V Power Supply	12V±5%
29	VDD		
30	VDD		

\* N.C. means "non connection"

Note 1: GND is signal ground for logic and LCD driving. GND should be connected to system ground.  
 GND is not connected to FG (Frame Ground) in this LCD module.

Note 2: Connect all pins (except 20,27) to avoid noise issue. Use 100Ω twist pair wires for the Cable.

CN2: Figure from socket view

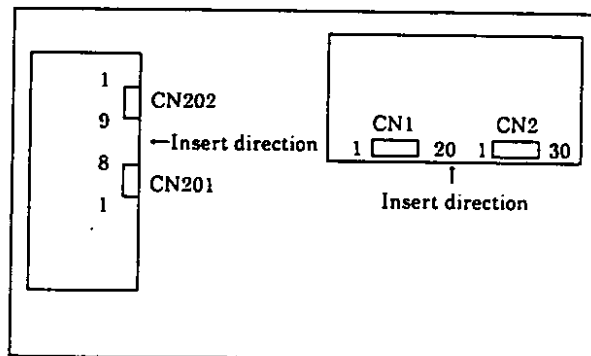
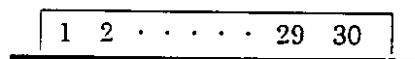

Note: Choice CN201 or CN202 and use one.

## (2) Connector for backlight unit

## CN201

Part No. : DF3-8P-2H  
 Adaptable socket : DF3-8S-2C  
 Supplier : HIROSE ELECTRIC CO., LTD.

Pin No.	Symbols	Signal type	Function
1	GNDB	Ground for backlight	Note 1
2	GNDB		
3	GNDB		
4	GNDB		
5	VDDB	12V power supply	+12V ± 5%
6	VDDB		
7	VDDB		
8	VDDB		

CN201: Figure from socket view

1	2	.....	7	8
---	---	-------	---	---

## CN202

Part No. : IL-Z-9PL1-SMTY  
 Adaptable socket : IL-Z-9S-S125C3  
 Supplier : Japan Aviation Electronics Industry Limited (JAE)

Pin No.	Symbols	Signal type	Function
1	GNDB	Ground for backlight	Note 1
2	GNDB		
3	ACA	Luminance control signal	"H" or "Open" : Normal luminance (100%) "L" : Low luminance (1/2 of normal luminance)
4	BRTC	Backlight ON/OFF control signal	"H" or "Open" : Backlight on "L" : Backlight off
5	BRTH	Luminance control signal-1	Note 2
6	BRTL	Luminance control signal-1	
7	BRTP	Luminance control signal-2	Note 3
8	GNDB	Ground for backlight	Note 1
9	PWSEL	Luminance control select signal	"H" or "Open" : Variable resistor control or voltage control (note 2) "L" : BRTP signal control (note 3)

Note 1: Neither GND nor GNDB connected to FG (Frame Ground) in this LCD module.  
 GND and GNDB should be connected to FG in customer equipment.

CN202: Figure from socket view

9	8	.....	3	2	1
---	---	-------	---	---	---

Note 2: The ways to luminance control by a variable resistor and voltage.

- (1) A way of luminance control by a variable resistor.  
The variable resistor for luminance control should be  $10\text{ k}\Omega$  type, and zero point of the resistor corresponds to the minimum of luminance.

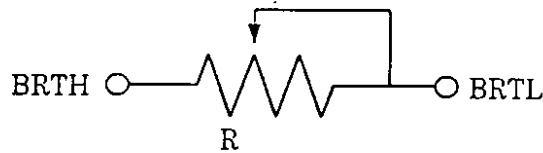

Mating variable resistor:  $10\text{ k}\Omega \pm 5\%$ , B curve  
Maximum luminance (100%):  $R=10\text{ k}\Omega$   
Minimum luminance (30%):  $R=0\Omega$

- (2) A way of luminance control by voltage  
BRTH should be fixed to  $0\text{V}$  to control luminance by voltage. The range of input voltage between BRTL and GNDB is as follows.  
Maximum luminance (100%, ACA=H):  $1\text{ V}$  (typ.)  
Minimum luminance (30%, ACA=H):  $0\text{ V}$

Note 3: The way of luminance control with B RTP signal

Outside control is valid, when PWSEL="L" and input signal for B RTP. Luminance can be controlled by the duty value of input signal for B RTP.

Duty=100%: luminance is maximum. (100%)  
Duty=20%: luminance is minimum. (30%)

Timing for B RTP

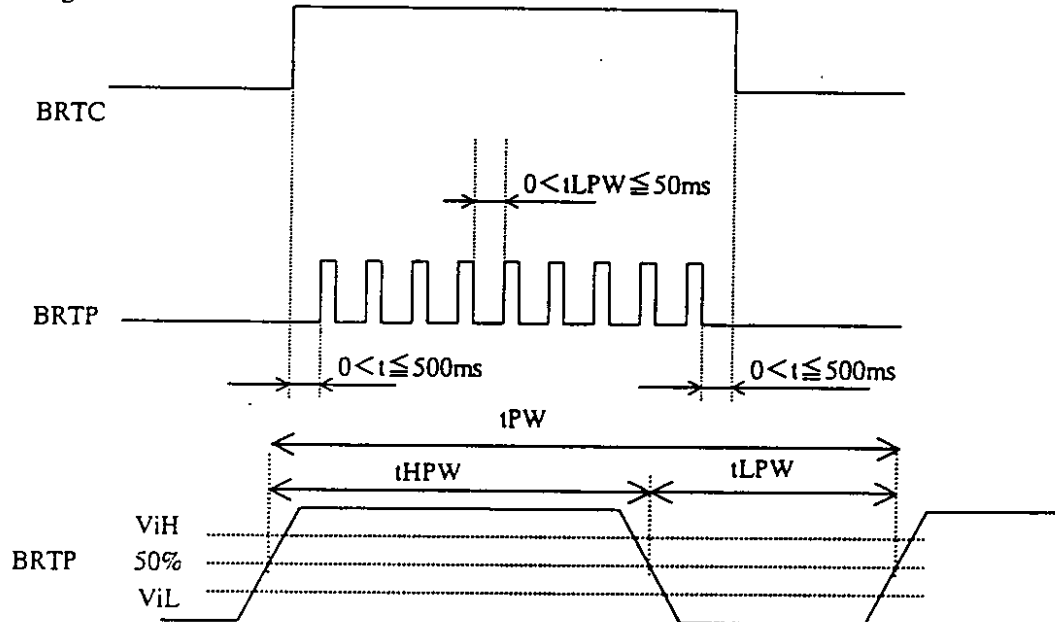

Parameters	Symbols	Min.	Typ.	Max.	Unit	Remarks
Frequency	1/1PW	185	—	325	Hz	—
"L" period	tLPW	—	—	50	ms	—
Pulse-width	tHPW/tPW	20	—	100	%	at max. luminance (100%)
Input voltage	ViL	0	—	0.8	V	—
	ViH	2.0	—	5.25	V	—

Regarding set up for frequency, refer to the below method.

Set up frequency = Vsync frequency  $\times$  (n+0.25) or (n+0.75)

Adopt the frequency evaluating the display quality, because the display will be disturbed depend on frequency.

12. METHOD OF CONNECTION FOR THC63LVDF83A

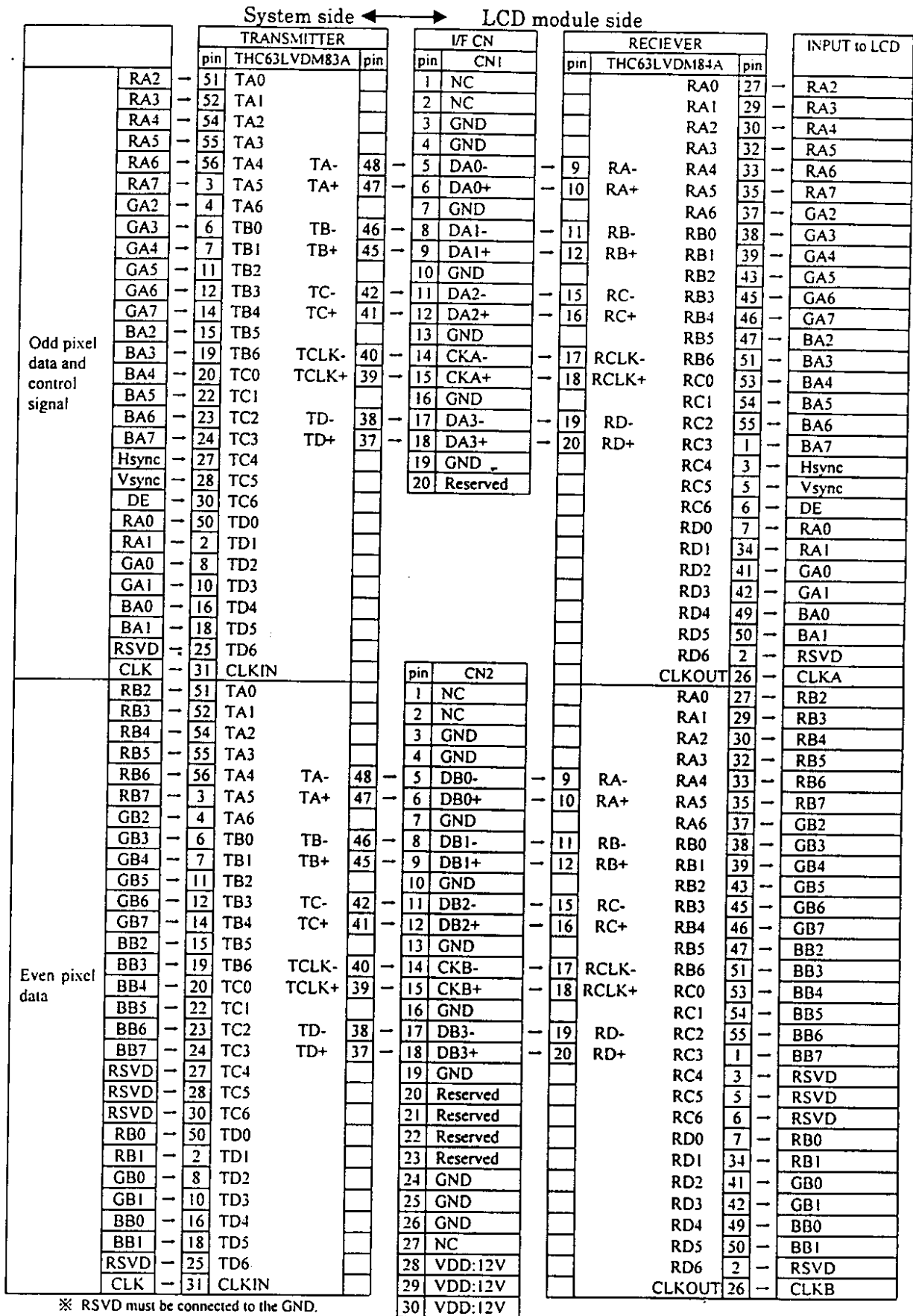

13. DISPLAY COLORS vs INPUT DATA SIGNALS

Display colors		Data signal(0: Low level, 1: High level)																							
		RA7 RA6 RA5 RA4 RA3 RA2 RA1 RA0								GA7 GA6 GA5 GA4 GA3 GA2 GA1 GA0								BA7 BA6 BA5 BA4 BA3 BA2 BA1 BA0							
		RB7 RB6 RB5 RB4 RB3 RB2 RB1 RB0	GB7 GB6 GB5 GB4 GB3 GB2 GB1 GB0	BB7 BB6 BB5 BB4 BB3 BB2 BB1 BB0																					
Basic colors	Black	0	0	0	0	0	0	0	0	0	0	0	0	0	0	0	0	0	0	0	0	0	0	0	0
	Blue	0	0	0	0	0	0	0	0	0	0	0	0	0	0	0	0	1	1	1	1	1	1	1	1
	Red	1	1	1	1	1	1	1	1	0	0	0	0	0	0	0	0	0	0	0	0	0	0	0	0
	Magenta	1	1	1	1	1	1	1	1	0	0	0	0	0	0	0	0	1	1	1	1	1	1	1	1
	Green	0	0	0	0	0	0	0	0	1	1	1	1	1	1	1	1	0	0	0	0	0	0	0	0
	Cyan	0	0	0	0	0	0	0	0	1	1	1	1	1	1	1	1	1	1	1	1	1	1	1	1
	Yellow	1	1	1	1	1	1	1	1	1	1	1	1	1	1	1	1	0	0	0	0	0	0	0	0
	White	1	1	1	1	1	1	1	1	1	1	1	1	1	1	1	1	1	1	1	1	1	1	1	1
Red grayscale	Black	0	0	0	0	0	0	0	0	0	0	0	0	0	0	0	0	0	0	0	0	0	0	0	0
	dark	0	0	0	0	0	0	0	1	0	0	0	0	0	0	0	0	0	0	0	0	0	0	0	0
	↑																								
	↓																								
	bright	1	1	1	1	1	1	0	1	0	0	0	0	0	0	0	0	0	0	0	0	0	0	0	0
Red	1	1	1	1	1	1	1	0	0	0	0	0	0	0	0	0	0	0	0	0	0	0	0	0	
Green grayscale	Black	0	0	0	0	0	0	0	0	0	0	0	0	0	0	0	0	0	0	0	0	0	0	0	0
	dark	0	0	0	0	0	0	0	0	0	0	0	0	0	0	0	1	0	0	0	0	0	0	0	0
	↑																								
	↓																								
	bright	0	0	0	0	0	0	0	0	1	1	1	1	1	1	0	1	0	0	0	0	0	0	0	0
Green	0	0	0	0	0	0	0	0	1	1	1	1	1	1	1	1	0	0	0	0	0	0	0	0	
Blue grayscale	Black	0	0	0	0	0	0	0	0	0	0	0	0	0	0	0	0	0	0	0	0	0	0	0	0
	dark	0	0	0	0	0	0	0	0	0	0	0	0	0	0	0	0	0	0	0	0	0	0	0	1
	↑																								
	↓																								
	bright	0	0	0	0	0	0	0	0	0	0	0	0	0	0	0	0	1	1	1	1	1	1	0	1
Blue	0	0	0	0	0	0	0	0	0	0	0	0	0	0	0	0	1	1	1	1	1	1	1	0	

Note: Colors are developed in combination with 8-bit signals (256 steps in grayscale) of each primary red, green, and blue color. This process can result in up to 16,777,216 (256×256×256) colors.



## 14. INPUT SIGNAL TIMINGS

(1) Input signal specification for LCD controller

	Parameters		Symbols	Min.	Typ.	Max.	Unit	Remarks
CLK	Frequency	Vf=75Hz	1/tc	65.0	67.5	70.0	MHz	—
				—	14.815	—	ns	
		Vf=60Hz		51.5	54.0	56.5	MHz	
				—	18.52	—	ns	
	Duty		tch/tcl	note 1			—	—
Rise, fall		trf				ns	—	
Hsync	Period	Vf=75Hz	th	(12.3)	12.504	—	ms	Typ=80.0kHz
				(750)	844	—	CLK	
		Vf=60Hz		(12.3)	15.630	—	ms	
				(750)	844	—	CLK	Typ=64.0kHz
	Display period		thd	—	640	—	CLK	—
	Front-porch		thf	—	—	—	CLK	—
	Pulse width	Vf=75Hz	thp *	—	72	—	CLK	—
		Vf=60Hz		—	56	—	CLK	
	Back-porch		thb *	—	124	—	CLK	—
		* thp + thb	(110)	—	—	CLK	—	
Vsync	Period	Vf=75Hz	tv	—	13.329	—	ms	Typ=75.0Hz
				(1027)	1066	—	H	
		Vf=60Hz		—	16.661	—	ms	
				(1027)	1066	—	H	Typ=60.0Hz
	Display period		tvd	—	1024	—	H	—
	Front-porch		tvf *	—	1	—	H	—
	Pulse width		tvp *	—	3	—	H	—
	Back-porch		tvb *	—	38	—	H	—
			* tvp + tvb + tvf	(1980)	—	—	H	—
	Vsync-Hsync timing		tvhs	1	—	—	CLK	—
Hsync-Vsync timing		tvhh	1	—	—	CLK	—	
Rise, fall		trf				ns	—	
DATA	DATA-CLK (Set up)	ts	note 1			ns	—	
	CLK-DATA (Hold)	th				ns	—	
						ns	—	

Note 1: These values are in the timing standard of THC63LVDF83A.  
Timing standard prescribes in the input of LVDS transmitter.  
THC63LVDF83A is recommended in LVDS transmitter.

(2) Input signal timing chart for LCD

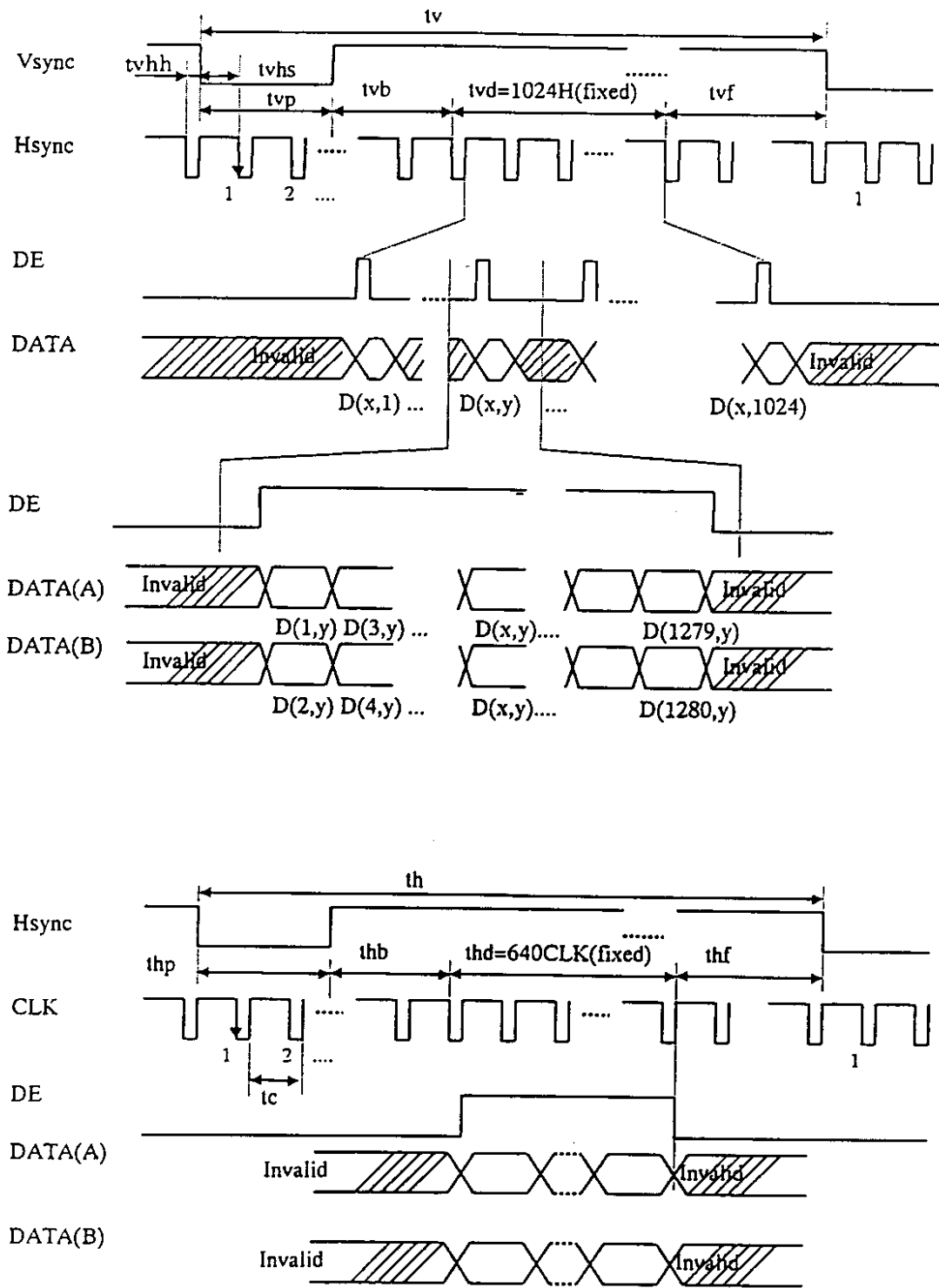

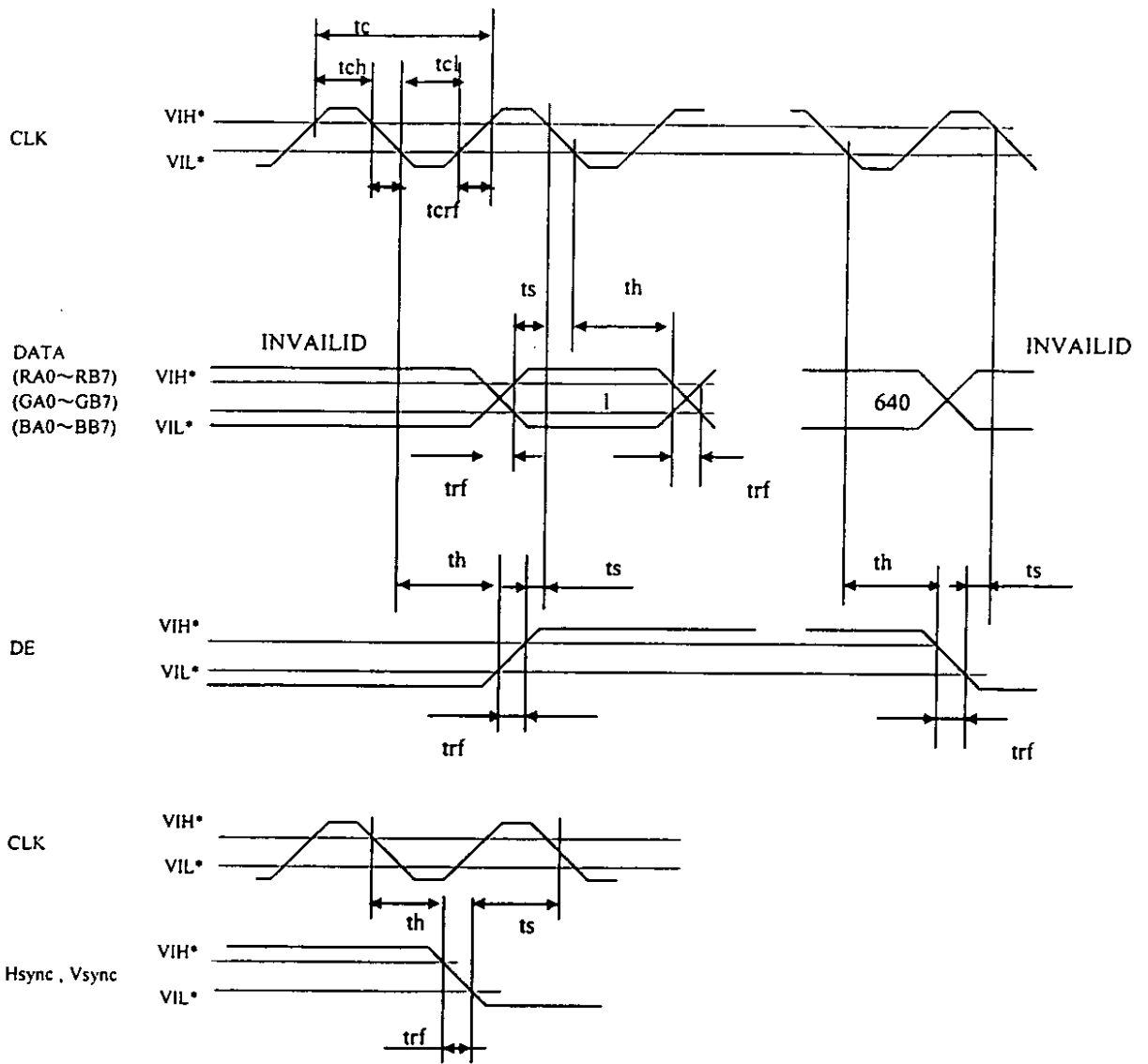

Note 1: See the specifications of LVDS manufactures for detailed design.

(3) Display position of input data

Odd Pixel: RA=R DATA  
 Odd Pixel: GA=G DATA  
 Odd Pixel: BA=B DATA

Even Pixel : RB=R DATA  
 Even Pixel : GB=G DATA  
 Even Pixel : BB=B DATA

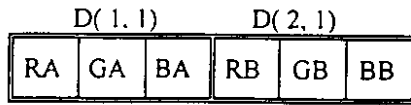

D(1,1)	D(2,1)	...	D(1280,1)
D(1,2)	D(2,2)	...	D(1280,2)
.	.	.	.
.	.	.	.
.	.	.	.
.	.	.	.
.	.	.	.
D(1,1024)	D(2,1024)	...	D(1280,1024)

## 15. OPTICAL CHARACTERISTICS

(Ta = 25 °C, VDD=12V, VDDB=12V, Note 1)

Parameters	Symbols	Conditions	Min.	Typ.	Max.	Unit	Remarks
Contrast ratio	CR	White / Black	—	400	—	—	Note 2
Luminance	Lumax	“White”	150	200	—	cd/m <sup>2</sup>	Note 5
Luminance uniformity	—	max. / min.	—	1.1	1.30	—	Note 6

## Reference data

(Ta=25°C, VDD=12V, VDDB=12V)

Parameters	Symbols	Conditions	Min.	Typ.	Max.	Unit	Remarks
Chromaticity Coordinates	W	White ( x, y )	-	0.31, 0.31	-	-	-
	R	Red ( x, y )	-	0.61, 0.34	-	-	-
	G	Green ( x, y )	-	0.32, 0.60	-	-	-
	B	Blue ( x, y )	-	0.15, 0.09	-	-	-
Color gamut	C	$\theta R=0^\circ, \theta L=0^\circ, \theta U=0^\circ, \theta D=0^\circ$ , at center, to NTSC	50	60	-	%	-
Viewing angle range (CR>10)	$\theta R$	CR > 10, White/Black	70	85	-	deg.	Note 3
	$\theta L$	$\theta U=0^\circ, \theta D=0^\circ$	70	85	-	deg.	
	$\theta U$	CR > 10, White/Black	70	85	-	deg.	
	$\theta D$	$\theta R=0^\circ, \theta L=0^\circ$	70	85	-	deg.	
Viewing angle range (CR>5)	$\theta R$	CR > 5, White/Black	-	85	-	deg.	
	$\theta L$	$\theta U=0^\circ, \theta D=0^\circ$	-	85	-	deg.	
	$\theta U$	CR > 5, White/Black	-	85	-	deg.	
	$\theta D$	$\theta R=0^\circ, \theta L=0^\circ$	-	85	-	deg.	
Response time	Ton	Black to White	-	45	70	ms	Note 4
	Toff	White to Black	-	35	60		
Luminance control range	—	Maximum luminance: 100%	-	30 to 100	-	%	-

Note 1: Viewing angle is  $\theta x = \pm 0^\circ$ ,  $\theta y = \pm 0^\circ$ . At center.

Note 2: The contrast ratio is calculated by using the following formula.

$$\text{Contrast ratio (CR)} = \frac{\text{Luminance with all pixels in "white"}}{\text{Luminance with all pixels in "black"}}$$

The luminance is measured in a darkroom.

Note 3: Definitions of viewing angle are as follows.

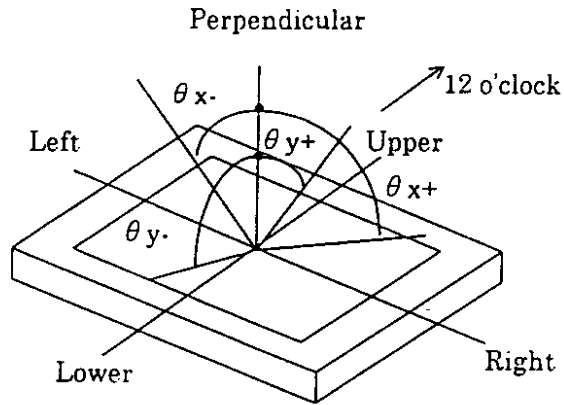

Note 4: Definition of response time is as follows.

Photo-detector output signal is measured when the luminance changes "black to white" or "white to black".

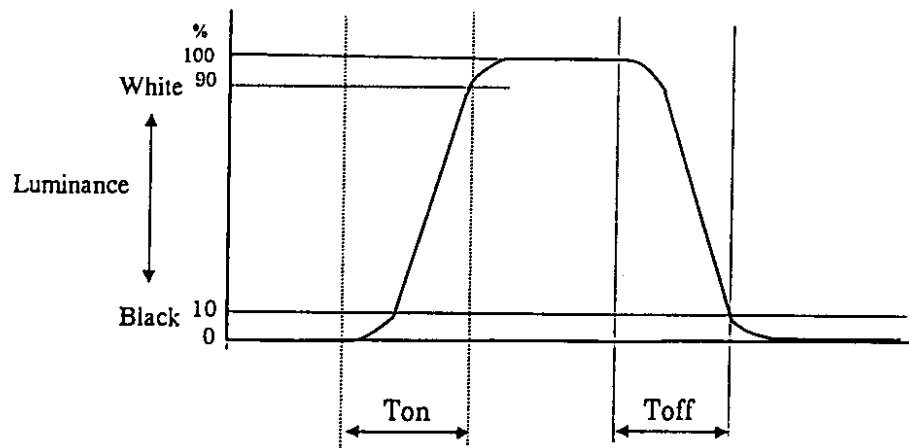

Note 5: The luminance is measured after 20 minutes from the module works, with all pixels in "white".

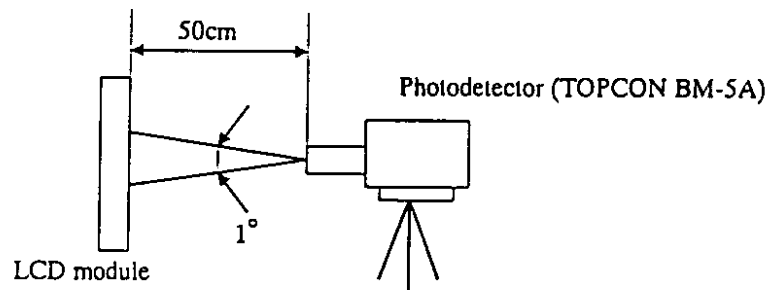

Note 6: The luminance uniformity is calculated by using following formula.

$$\text{Luminance uniformity} = \frac{\text{Maximum Luminance}}{\text{Minimum Luminance}}$$

The luminance is measured at near the five points shown below.

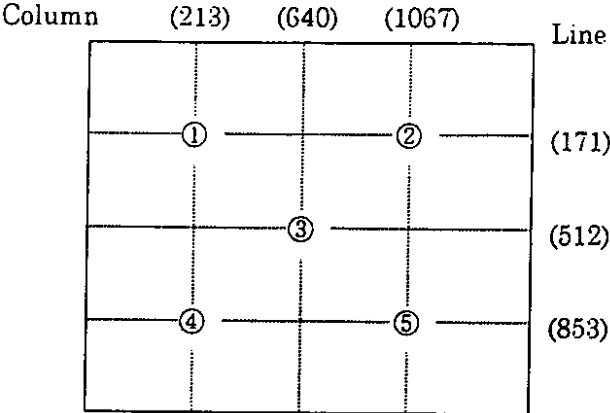

## 16. RELIABILITY TEST

Test items	Test conditions	Judgment
High temperature/humidity operation	60±2°C, RH=60% 240 hours, Display data is black.	*1
Heat cycle (operation)	① 0°C±3°C···1 hour 55°C±3°C···1 hour ② 50 cycles, 4 hours/cycle ③ Display data is black.	*1
Thermal shock (non-operation)	① -20°C±3°C···30 minutes 60°C±3°C···30 minutes ② 100 cycles ③ Temperature transition time is within 5 minutes.	*1
Vibration (non-operation)	① 5-100Hz, 11.76m/s <sup>2</sup> (1.2G), 1 minute/cycle, X,Y,Z direction ② 10 times each direction	*1, *2
Mechanical shock (non-operation)	① 294m/s <sup>2</sup> (30G), 11ms X,Y,Z direction ② 3 times each direction	*1, *2
ESD (operation)	150pF, 150Ω, ±10kV 9 places on a panel *3 10 times each place at one-second intervals	*1
Dust (operation)	15 kinds of dust (JIS-Z 8901) Hourly 15 seconds stir, 8 times repeat	*1

\*1: Display function is checked by the same condition as LCD module out-going inspection.

\*2: Physical damage

\*3: Discharge points are shown in the figure.

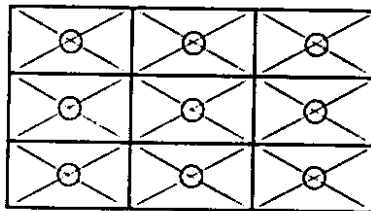

## 17. EXPECTED LIFE-TIME OF THE LAMP

	Lamp
Conditions	Luminance Maximum Room temp. (25±2°C), Continuous operation
Expected value (MTTF)	50,000h
Criteria	Half value luminance (compared with initial value.)

Note 1: The lifetime is expected value (reference).

Note 2: This module consists of eight lamps.

Note 3: Chromaticity coordinates change after the expected lifetime.



## 18. GENERAL CAUTIONS

Because next figures and sentences are very important, please understand these contents as follows.



### CAUTION

This figure is a mark that you will get hurt and/or the module will have damages when you make a mistake to operate.



This figure is a mark that you will get an electric shock when you make a mistake to operate.



This figure is a mark that you will get hurt when you make a mistake to operate.



### CAUTIONS



Do not touch an inverter --on which a caution label is stucked-- while the LCD module is under the operation, because of dangerous high voltage.

- (1) Caution when taking out the module
  - a. Pick a pouch only, when taking out the module from a carrier box.
- (2) Cautions for handling the module
  - a. As the electrostatic discharges may break the LCD module, handle the LCD module with care against electrostatic discharges.
  - b.
    - 

As the LCD panel and backlight element are made from fragile glass material, impulse and pressure to the LCD module should be avoided.
    - c. As the surface of polarizer is very soft and easily scratched, use a soft dry cloth without chemicals for cleaning.
    - d. Do not pull the interface connectors in or out while the LCD module is operating.
    - e. Put the module display side down on a flat horizontal plane.
    - f. Handle connectors and cables with care.
    - g. When the module is operating, do not lose CLK, HS, or Vsync signal. If any one or more of these signals is lost, the LCD panel would be damaged.
    - h. The torque for mounting screw should never exceed  $0.451 \text{ N} \cdot \text{m}$  ( $4.6 \text{ kgf} \cdot \text{cm}$ ).

- i. Don't push or rub the surface of LCD module.

If you do, the scratches or the rubbing marks may be left on the surface of the *module*.

- j. Do not put front side (display surface side ) of the module on a desk or a table for a long time, because the display may become un-uniformity

(3) Cautions for the atmosphere

- a. Dew drop atmosphere must be avoided.

- b. Do not store and/or operate the LCD module in a high temperature and/or high humidity atmosphere. Storage in an anti-static pouch and under the room temperature atmosphere is recommended.

- c. This module uses cold cathode fluorescent lamps. Therefore, the life of lamps becomes short if the module is operated in the low temperature environment.

- d. Do not operate the LCD module in high magnetic field.

(4) Cautions for the module characteristics

- a. Do not apply any fixed patterns for a long time to the LCD module. It may cause image sticking. Please use the screen savers if the display pattern is fixed for a long time.

- b. This module has the retardation film, which may cause the variation of the color hue in the different viewing angles. The ununiformity may appear on the screen under the high temperature operation.

- c. The light vertical stripe may be observed depending on the display pattern. This is not defects nor malfunctions.

- d. The noise from the inverter circuit may be observed in the luminance control mode. This is not defects nor malfunctions.

(5) Other cautions

- a. Do not disassemble and/or reassemble LCD module.

- b. Do not readjust any variable resistors or switches in the module.

- c. When returning the module for repair or etc., pack the module properly to avoid any damages. We recommend using the original shipping packages.

Liquid Crystal Display has the following specific characteristics. There are not defects or malfunctions.

The ambient temperature may affect the optical characteristics of this module. This module has cold cathode tube for backlight. Optical characteristics, like luminance or uniformity, will be changed by the progress in time.

Uneven brightness and/or small spots may be observed depending on different display patterns.



19. OUTLINE DRAWINGS  
19.1 Front view (Unit: mm)

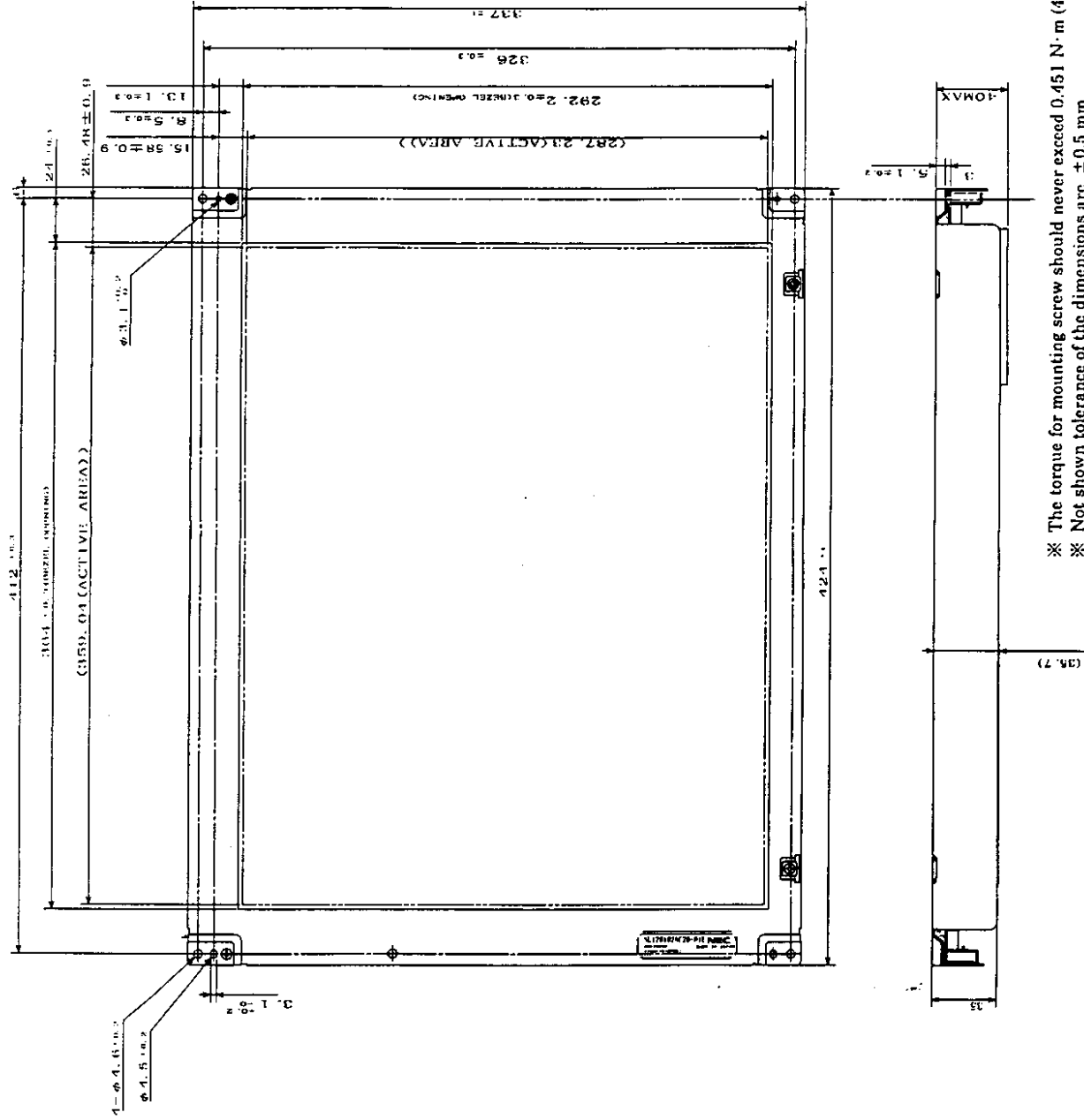

Revision History				DOD-H-7485		29/29
Rev.	prepared date	Revision contents	Approved	Checked	Prepared	Issued date
1	Oct. 27, 1999	DOD-H-7485	<i>A. Jaki</i>	—	<i>y. Olanda</i>	