

# TFT COLOR LCD MODULE

## NL10276AC30-01A

**38 cm (15 inches), 1024 × 768 pixels, Full-color,  
Multi-scan Function, Built-in backlight with inverter  
Ultra wide viewing angle**

### DESCRIPTION

NL10276AC30-01A is a TFT (thin film transistor) active matrix color liquid crystal display (LCD) comprising amorphous silicon TFT attached to each signal electrode, a driving circuit, a CRT interface board and a backlight. NL10276AC30-01A has a built-in backlight with an inverter.

The 38cm (15" inches) diagonal display area contains 1024 × 768 pixels and can display full-color (more than 16 million colors simultaneously). Also, it has ultra-wide viewing angle and multi-scan function. Therefore, this module calls Super Fine TFT.

CRT interface board installed in this module allows you to achieve the LCD monitor with an analog RGB interface.

### FEATURES

- Ultra wide viewing angle
- Multi-scan function
  - e.g. XGA, SVGA, VGA, VGA-TEXT, PC-9801, MAC
- High luminance
- Incorporated edge type backlight (Four lamps into two lamp holders, Inverter)
- Lamp holder replaceable (Part No. 150LHS01)
- On Screen Display
- CRT interface board
  - Auto recognition of input signal
    - Analog RGB signals, Sync on green, Synchronous signals (HS, Vsync, Composite)
  - Digital control: e.g. Brightness, Display position, Contrast, CLK delay
  - Free supply voltage sequence
  - Corresponding to DDC1 and DDC2B
  - Corresponding to VESA DPMS

Regarding the use of OSD, please note that there is possibility of conflicts with a patent in Europe and the U.S. Thus, if such conflict might happen when you use OSD, we shall not be responsible for any trouble.

VESA : Video Electronics Standards Association

DPMS : Display Power Management Signaling

DDC1 : Display Data Channel 1

DDC2B : Display Data Channel 2B

### APPLICATIONS

- Engineering workstation (EWS), Desk-top type of PC

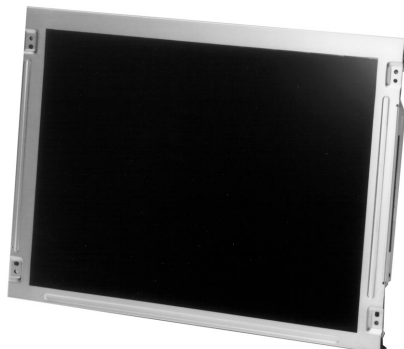

The information in this document is subject to change without notice.

**STRUCTURE AND FUNCTIONS**

A color TFT (thin film transistor) LCD module is comprised of a TFT liquid crystal panel structure, LSIs for driving the TFT array, and a backlight assembly. The TFT panel structure is created by sandwiching liquid crystal material in the narrow gap between a TFT array glass substrate and a color filter glass substrate. After the driver LSIs are connected to the panel, the backlight assembly is attached to the backside of the panel.

RGB (red, green, blue) data signals from a source system is modulated into a form suitable for active matrix addressing by the onboard signal processor and sent to the driver LSIs which in turn addresses the individual TFT cells.

Acting as an electro-optical switch, each TFT cell regulates light transmission from the backlight assembly when activated by the data source. By regulating the amount of light passing through the array of red, green, and blue dots, color images are created with clarity.

**BLOCK DIAGRAM**

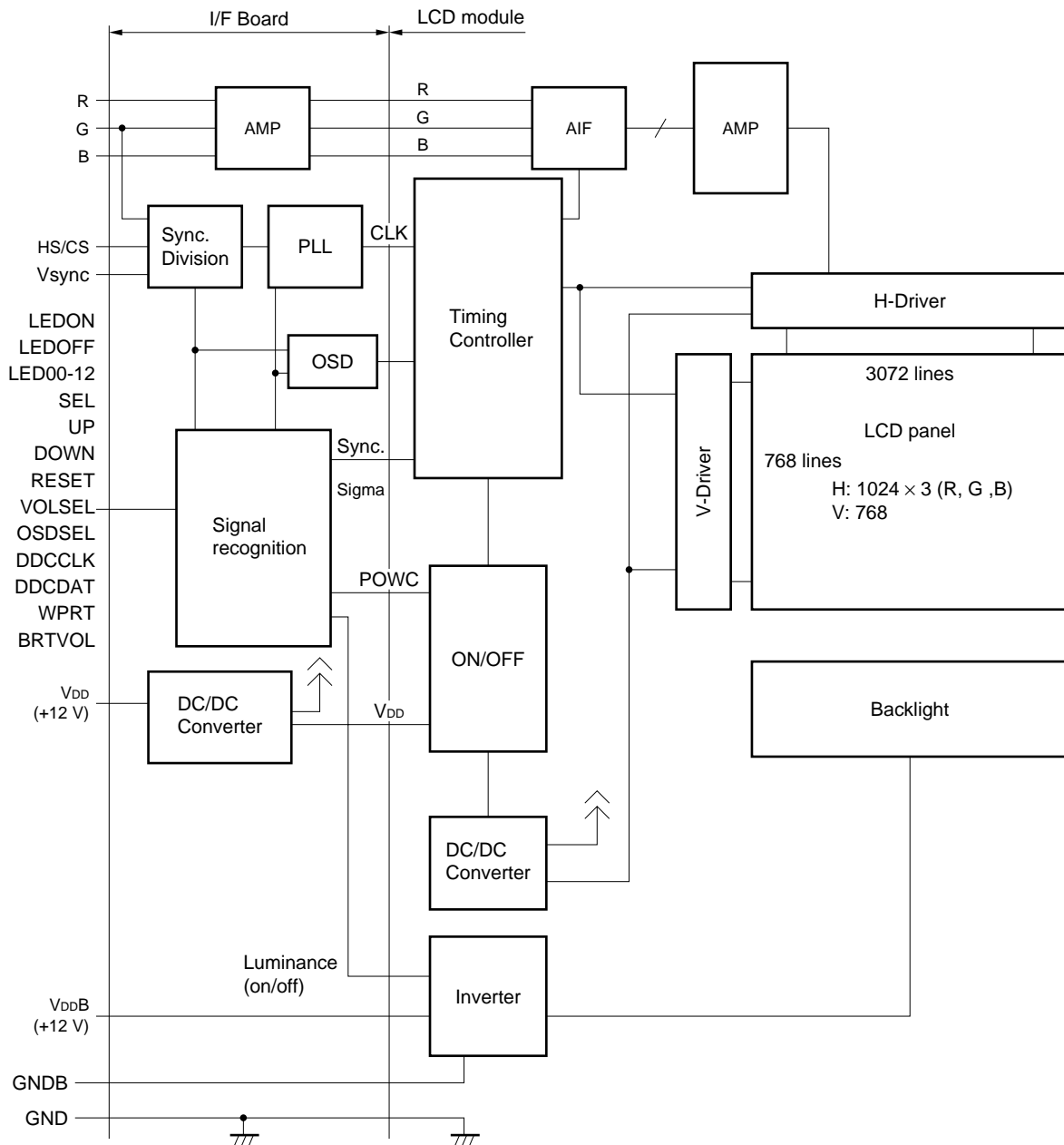

**Note** Frame is not connected to GND nor GNDB.

**OUTLINE OF CHARACTERISTICS (at room temperature)**

Display area	304.128 (H) × 228.096 (V) mm
Drive system	a-Si TFT active matrix
Display colors	Full-color
Number of pixels	1024 × 768
Pixel arrangement	RGB vertical stripe
Pixel pitch	0.297 (H) × 0.297 (V) mm
Module size	350.0 (H) × 265.0 (V) × 23.0 (D) mm (typ.)
Weight	1480 g (typ.)
Contrast ratio	150:1 (typ., perpendicular)
Viewing angle (more than the contrast ratio of 10:1)	<ul style="list-style-type: none"> <li>• Horizontal: 85° (typ., left side, right side)</li> <li>• Vertical : 85° (typ., up side, down side)</li> </ul>
Optimum grayscale	perpendicular ( $\gamma = 2.2$ )
Polarizer pencil-hardness	3H (min., JISK5400)
Color gamut	48 % (typ., At center, To NTSC)
Response time	44 ms (typ.), "black" to "white"
Luminance	180 cd/m <sup>2</sup> (typ.)
Input signals	Analog RGB, Vsync and HS
Backlight	Edge light type: Four cold cathode fluorescent lamps with an inverter <Replacement parts> Inverter P/N: 150PW011 Lamp holder set P/N: 150LHS01
Supply voltage	12 V (typ.), 12 V (typ.)
Power consumption	24.7 W (typ.)

www.DataSheet4U.com

**GENERAL SPECIFICATIONS**

Item	Contents	Unit
Module size	350.0 ± 0.6 (H) × 265.0 ± 0.6 (V) × 24.0 (max.) (D)	mm
Display area	304.128 (H) × 228.096 (V)	mm
Number of dots	1024 × 3 (H) × 768 (V)	dots
Pixel pitch	0.297 (H) × 0.297 (V)	mm
Dot pitch	0.099 (H) × 0.297 (V)	mm
Pixel arrangement	RGB (Red, Green, Blue) vertical stripe	–
Display colors	Full color	color
Weight	1,480 (typ.), 1600 (max.)	g

**ABSOLUTE MAXIMUM RATINGS**

Parameter	Symbol	Rating	Unit	Remarks
Supply voltage	V <sub>DD</sub>	–0.3 to + 14	V	Ta = 25°C
	V <sub>DDB</sub>	–0.3 to + 14	V	
Logic input voltage	V <sub>IN1</sub>	–0.3 to + 5.5	V	Ta = 25°C V <sub>DD</sub> = 12 V
R, G, B input voltage	V <sub>IN2</sub>	–6.0 to + 6.0	V	
CLK input voltage	V <sub>IN3</sub>	–7.0 to + 7.0	V	
Storage temp.	T <sub>ST</sub>	–20 to + 60	°C	–
Operating temp.	T <sub>OP</sub>	0 to 50	°C	Module surface <b>Note 1</b>
Humidity (no condensation)	≤ 95% relative humidity			Ta ≤ 40°C
	≤ 85% relative humidity			40 < Ta ≤ 50°C
	Absolute humidity shall not exceed Ta = 50°C, 85% relative humidity level.			Ta > 50°C

- Notes** 1. Measured at the LCD panel (Include own fever)  
 2. No condensation

**ELECTRICAL CHARACTERISTICS**

**(1) Logic, LCD driving, Backlight**

(Ta = 25°C)

Item	Symbol	Min.	Typ.	Max.	Unit	Remarks
Supply voltage	V <sub>DD</sub>	11.4	12.0	12.6	V	Logic and LCD driving
	V <sub>DD</sub> B	11.4	12.0	12.6	V	Backlight
Logic input "L" voltage	V <sub>IL</sub>	0	–	0.8	V	HS/CS, Vsync, SEL, UP, DOWN, RESET, VOLSEL, DDCCLK, DDCDAT, OSDSEL, WPRT
Logic input "H" voltage	V <sub>IH</sub>	2.2	–	5.25	V	
Logic output "L" voltage	VOL1	–	–	0.4	V	LED00/01/02/10/11/12
Logic output "H" voltage	VOH1	2.4	–	–	V	
Logic input "L" current 1	I <sub>IL1</sub>	–1	–	–	μA	HS/CS, Vsync
Logic input "H" current 1	I <sub>IH1</sub>	–	–	1	μA	
Logic output "L" current 1	I <sub>OL1</sub>	–	–	1	μA	DDCDAT
Logic output "H" current 1	I <sub>OH1</sub>	–1	–	–	μA	
Supply current (Dot-checked pattern)	I <sub>DD</sub>	–	660	850	mA	V <sub>DD</sub> = 12.0 V <b>Note1</b>
		–	45	65	mA	Power saving mode V <sub>DD</sub> = 12.0 V <b>Note1</b>
	I <sub>DD</sub> B	–	1400	1600	mA	V <sub>DD</sub> B = 12.0 V (Max. luminance)
		–	1	10	mA	Power saving mode V <sub>DD</sub> B = 12.0 V

**Note** Pixel checkered pattern

**(2) Video signal (R, G, B) input**

(Ta = 25°C)

Item	Min.	Typ.	Max.	Unit	Remarks
Maximum amplitude (white - black)	0 (black)	0.7 (white)	*A	Vp-p	<b>Note</b>
DC input level (black)	–0.5	–	+2.5	V	–
Sync level	0.2	0.3	*B	Vp-p	G terminal (sync on green)
*A + *B	–	–	1.1	Vp-p	

**Note** Need to adjust contrast if the input level is beyond 0.7 Vp-p.

**POWER SUPPLY DESIGN**

**(1) Ripple voltage of the supply voltage**

Please note that the ripple at the input connector of the module should be within the values shown in this table. If the ripple would be beyond these values, the noise might appear on the screen.

	V <sub>DD</sub> (for logic and LCD driver)	V <sub>DD</sub> B (for backlight)
Acceptable range	≤ 100 mVp-p	≤ 200 mVp-p

**Note** The acceptable range of ripple voltage includes spike noises.

www.DataSheet4U.com

Example of the power supply connection to minimize the ripple voltage

**a) Separate the power supply**

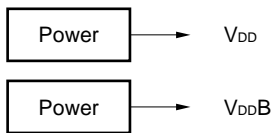

**b) Put the filter**

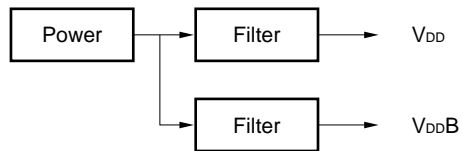

**(2) Current wave in the luminance control mode**

In the luminance control mode, the rush current below flows into the inverter of the module. The duty cycle varies from 100% through 20% depending on the luminance control level. This might cause the noise on the screen. Please evaluate the appropriate value of the capacitor in the filter to eliminate the noise.

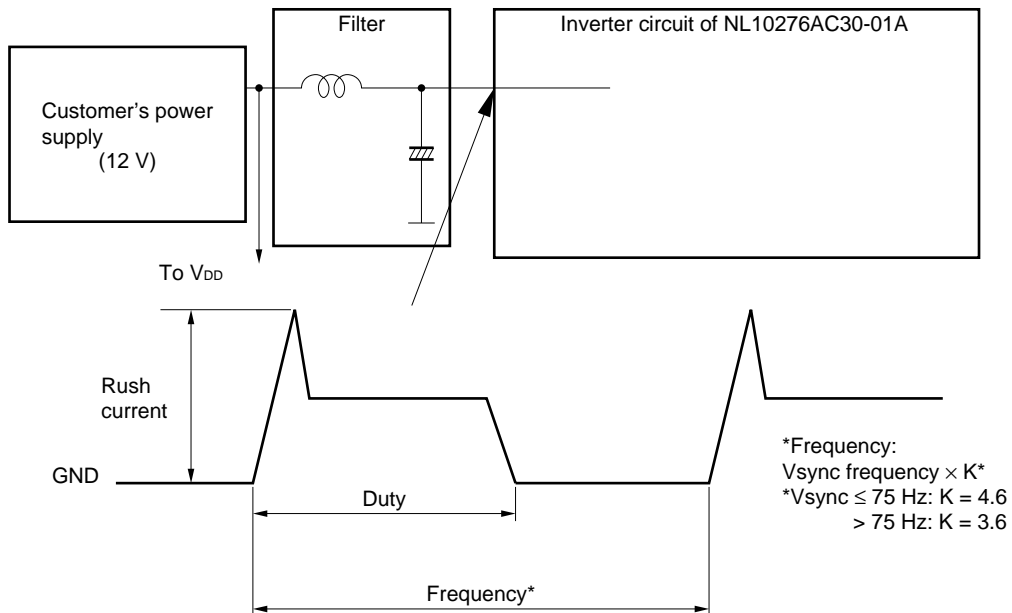

**POWER SUPPLY SEQUENCE**

There is no sequence among the synchronous signals, the video signals and the power supply. However, 12 V for backlight should be started up within 80 ms, otherwise, the protection circuit makes the backlight turns off.

Please note that the supply voltage must not be applied while the control signals (SEL, UP, DOWN and RESET) are connected to GND. Otherwise the module may cause malfunctions.

If the power supply voltage is applied while SEL and RESET is connected to GND, the mode is set into NEC factory mode. In this case, both LEDON and LEDOFF become "H". Please do not use the module in this mode which may write over the default value. Please turn off the power supply immediately and turn on the power while SEL and RESET are connected to GND again. If the default value has been revised by accident, please follow the instruction below.

<NEC factory mode>

This mode can control Brightness and Contrast and OSD position. Factory Reset function is reset all values. But do not use the module in this mode which may write over the default values affect to the LCD internal operation. Please turn off the power immediately and turn on the power while SEL and RESET are connected to GND again. If the default value has been revised by accident, please select "Factory Reset" mode and press "Reset" key for over two seconds.

Functions	Control contents	How to reset
Brightness	Total Brightness and Sub Brightness for each RGB	Press RESET key over 2 seconds
Contrast	Total Contrast and Sub Contrast for each RGB	Press RESET key over 2 seconds
LCD Data	Never select and adjust values	Please go to the Factory reset.
Color adjust		
VCO		
HDTV Select		
OSD position	Change the OSD display position	-
Factory Reset	Above function values is reset to factory values.	Press Reset key over 2 seconds.
RESET	RESET the NEC factory mode	-

**INTERFACE AND PIN CONNECTION**

**(1) Interface signals, power supply**

CN101

Part No. : 1-353119-4

Adaptable socket : 1-353068-04

Supplier : Japan AMP Ltd.

Pin No.	Symbol	Pin No.	Symbol
1	B	8	Vsync
2	B-GND	9	GND
3	G	10	HS/CS
4	G-GND	11	GND
5	R	12	DDCCLK
6	R-GND	13	N.C.
7	GND	14	DDCDAT

Figure from socket view

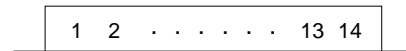

**Note** N.C. (No connection) should be open.

CN103

Part No. : DF14A-25P-1.25H

Adaptable socket : DF14-25S-1.25C

Supplier : HIROSE ELECTRIC CO., LTD.

Pin No.	Symbol	Pin No.	Symbol
1	LEDON	14	RESET
2	LEDOFF	15	GND
3	GND	16	BRTVOL
4	LED00	17	GND
5	LED01	18	VOLSEL
6	LEDD02	19	OSDSEL
7	LED10	20	WPRT
8	LED11	21	N.C.
9	LED12	22	N.C.
10	GND	23	GND
11	SEL	24	N.C.
12	UP	25	N.C.
13	DOWN		

Figure from socket view

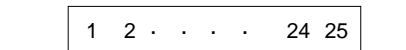

**Note** N.C. (No connection)



CN104

Part No. : IL-Z-8PL-SMTY  
 Adaptable socket : IL-Z-8S-S125C3  
 Supplier : Japan Aviation Electronics Industry Limited (JAE)

Pin No.	Symbol	Pin No.	Symbol
1	V <sub>DD</sub>	5	GND
2	V <sub>DD</sub>	6	GND
3	V <sub>DD</sub>	7	GND
4	V <sub>DD</sub>	8	GND

Figure from socket view

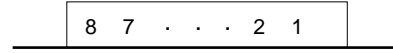

www.DataSheet4U.com

CN201

Part No. : IL-Z-11PL1-SMTY  
 Adaptable socket : IL-Z-11S-S125C3  
 Supplier : Japan Aviation Electronics Industry Limited (JAE)

Pin No.	Symbol	Pin No.	Symbol
1	V <sub>DD</sub> B	7	N.C.
2	V <sub>DD</sub> B	8	N.C.
3	V <sub>DD</sub> B	9	N.C.
4	G <sub>N</sub> DB	10	N.C.
5	G <sub>N</sub> DB	11	N.C.
6	G <sub>N</sub> DB		

Figure from socket view

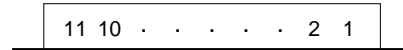

**Note** N.C. (No connection) should be open.

Rear view

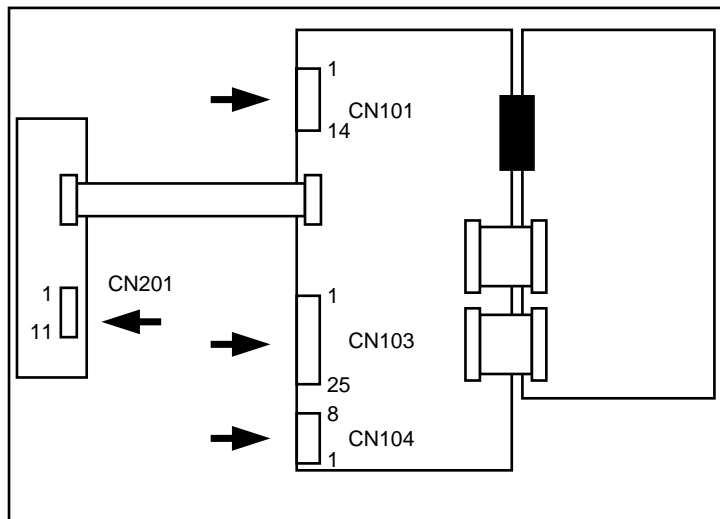

## (2) Pin function

Symbol	I/O	Logic	Description
HS/CS	Input	Negative	Horizontal synchronous signal or composite synchronous signal (TTL level), Positive/Negative auto recognition
Vsync	Input	Negative	Vertical synchronous signal (TTL level) Positive/Negative auto recognition, Clock input for DDC1
R	Input	–	Red video signal (0.7 Vp-p, 75 Ω)
G	Input	–	Green video signal (0.7 Vp-p, 75 Ω), Sync On Green input
B	Input	–	Blue video signal (0.7 Vp-p, 75 Ω)
LEDON	Output	Positive	Output terminal to light up LED “H”: Power on “L”: Power off
LEDOFF	Output	Positive	Output terminal to light up LED “H”: Power save mode “L”: Normal mode
LED00	Output	Positive	<b>For details, see Equivalent circuit for LED and CONTROL FUNCTIONS</b>
LED01	Output	Positive	
LED02	Output	Positive	
LED10	Output	Negative	
LED11	Output	Negative	
LED12	Output	Negative	
DDCCLK	Input	Positive	
DDCDAT	Input/ Output	Positive	Data for DDC1/2B Read/write
SEL	Input	Negative	Select signal for control functions (TTL level) “open”: SEL off, “L”: SEL on For details, see <b>CONTROL FUNCTIONS</b>
UP	Input	Negative	Control signal (TTL level) UP increases the value of the functions selected. “open”: UP off, “L”: UP on
DOWN	Input	Negative	Control signal (TTL level) DOWN reduces the value of the functions selected. “open”: DOWN off, “L”: DOWN on
RESET	Input	Negative	Control signal (TTL level) RESET initializes the selected functions. “open”: RESET off “L”: RESET on
BRTVOL	Input	–	Luminance control terminal For details, see. <b>Luminance control select</b>
VOLSEL	Input	–	Luminance control select signal (TTL level) VOLSEL is pulled up in the module. For details, see <b>Luminance control select</b>
OSDSEL	Input	–	Display select signal (TTL level) “open”: OSD display off (light on LED) “L”: OSD display on (light off LED) For details, see <b>CONTROL FUNCTIONS</b>
WPRT	Input	Positive	Select signal for DDC “Open”: Reading mode, “L”: Writing mode

Symbol	I/O	Logic	Description
V <sub>DD</sub>	-	-	Power supply for Logic and LCD driving +12 V (±5%)
V <sub>DD</sub> B	-	-	Power supply for backlight. +12 V (±5%) <sup>Note2</sup>
GND	-	-	Ground for system. <sup>Note1</sup>
GNDB	-	-	Ground for backlight. <sup>Note1</sup>

**Notes** 1: Ground for frame, system (GND) and backlight (GNDB) are not connected in the module.

2: 12 V for backlight should be started up within 80 ms, otherwise, the protection circuit makes the backlight turns off.

www.DataSheet4U.com

**(3) LUMINANCE CONTROL SELECT**

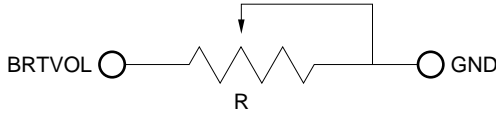
VOLSEL =	"L"	"Open"
Form	Digital adjust	Volume adjust
How to adjust	See <b>CONTROL FUNCTIONS</b>	<p>The variable resistor for luminance control should be 10 kΩ type, and zero point of the resistor corresponds to the minimum of luminance.</p>  <p>Maximum luminance (100%): R = 10 KΩ                      Minimum luminance (20%): R = 0 Ω                      Matching variable resistor: 10 KΩ ±5%,                      B curve, 1/10 W</p>

**Note** The status of VOLSEL is valid when the power is switched on.

**(4) FUNCTION DISPLAY SELECT**

OSDSEL =	"L"	"Open"
Form	OSD Display	LED Display
How to adjust	See <b>CONTROL FUNCTIONS</b>	See detail of recommendation circuit diagram. Note: Next page

**Note** The status of OSDSEL is valid when the power is switched on.

Regarding the use of OSD, please note that there is possibility of conflicts with a patent in Europe and the U.S.

Thus, if such conflict might happen when you use OSD, we shall not be responsible for any trouble.

(5) EQUIVALENT CIRCUIT FOR LEDs

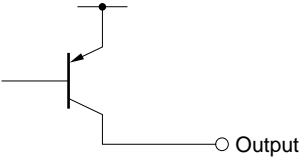
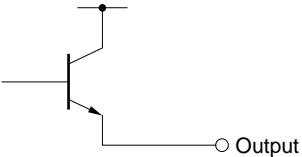
Symbol	I/O	Equivalent circuit
LEDON LEDOFF LED00 LED01 LED02	Output	RN2306 (Toshiba) Or equivalent 
LED10 LED11 LED12	Output	N-ch Open-drain Output 

www.DataSheet4U.com

<Example of LED circuit>

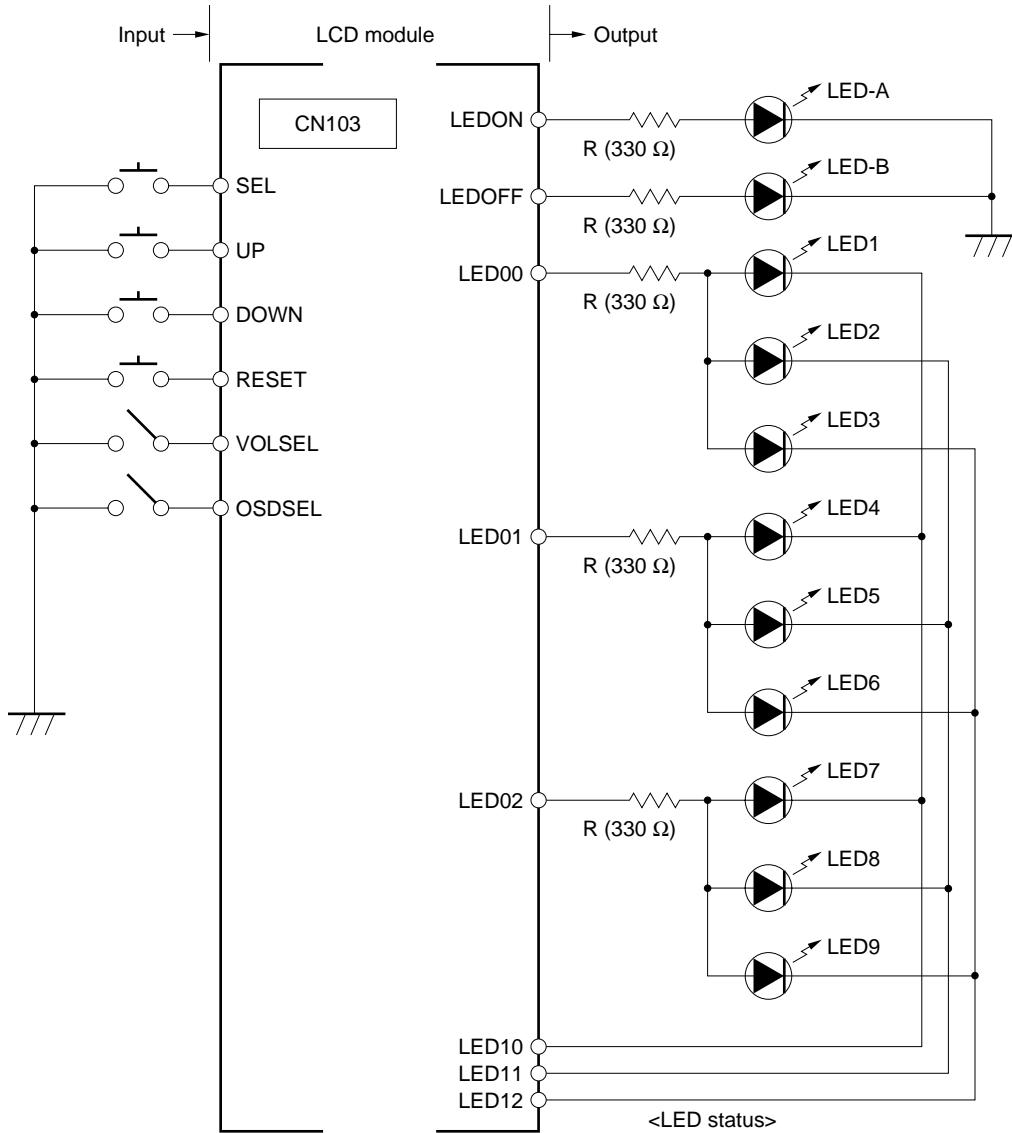

www.DataSheet4U.com

- LED-A: Power on
- LED-B: Power-save mode
- LED1: Luminance
- LED2: Contrast
- LED3: Horizontal display period
- LED4: CLK delay
- LED5: Vertical position
- LED6: Horizontal position
- LED7: Reserve
- LED8: All reset
- LED9: Reserve

**INPUT SIGNALS**

**(1) SYNCHRONOUS SIGNAL**

This module is corresponding to the synchronous signals below.

Auto recognition mode	Synchronous signal		
	HS/CS	Vsync	Sync. On Green
Separate synchronous signal mode (HS, Vsync)	Input	Input	Input or no input
Composite synchronous mode	Input	No input	Input or no input
Sync. On Green mode	No input	No input	Input
Power save mode	No input	No input	No input

**Note** Power save mode corresponds to VESA DPMA.

**(2) PRESET TIMINGS**

The fourteen kinds of timings below are already programmed in this module. The input synchronous signals are automatically recognized.

Preset No.	Display size	Dot CLK (MHz)	Hsync (kHz)	Vsync (Hz)	Remark
1	640 × 400	21.053	24.830	56.432	NEC PC98
2	640 × 480	25.175	31.469	59.992	VGA
3	720 × 400	28.322	31.469	70.087	VGA TXT
4	800 × 600	40.000	37.879	60.317	VESA
5	640 × 480	30.240	35.000	66.667	Macintosh
6	640 × 480	31.500	37.500	75.000	VESA
7	720 × 400	35.500	37.927	85.039	VESA
8	640 × 480	36.000	43.269	85.008	VESA <sup>Note</sup>
9	1024 × 768	65.000	48.363	60.004	VESA
10	800 × 600	49.500	46.875	75.000	VESA
11	832 × 624	57.283	49.735	74.565	Macintosh
12	800 × 600	56.250	53.674	85.061	VESA <sup>Note</sup>
13	1024 × 768	75.000	56.476	70.069	VESA
14	1024 × 768	78.750	60.023	75.029	VESA

**Note** Out of specification.

Even if the preset timing is entered, a little adjustment of the functions such as Horizontal period, CLK-delay and display position, are required. The adjusted values are memorized in every preset No.

This module recognizes the synchronous signals with near preset timing of the frequency of HS, Vsync, even in the case that the signals other than the preset timing that were entered. For instance, it is displayed with presetting number 6 in the case of 640 × 480 dot, HS: 37.861 kHz, Vsync: 72.809 Hz an example).

Adopt the evaluation, because adjustment may not fit, in the case that the magnifying ratio differs, in the case that you use it with except for the display timing that was preset.

**(3) EXPANSION MODE**

Expansion mode is a function to expand the screen size in different resolutions. For example, VGA signal has 640 × 480 pixels. But, if the display data can be expanded to 1.6 times vertically and horizontally, VGA screen image can be displayed fully on the screen of XGA resolution. This module automatically recognizes the timing shown in item 7.7.2 as an expansion mode.

Please adopt this mode after evaluating display quality, because the appearance in the expansion mode is happened to become bad in some cases.

The followings show the display magnifications in each mode.

Input display	Number of pixels	Magnification	
		Vertical	Horizontal
XGA	1024 × 768	1	1
SVGA	800 × 600	1.25	1.25
VGA	640 × 480	1.6	1.6
VGA text	720 × 400	1.6	1.4
PC9801	640 × 400	1.6	1.6
MAC	832 × 624	1.2	1.2

<DISPLAY IMAGE>

1) SVGA mode (800 × 600)

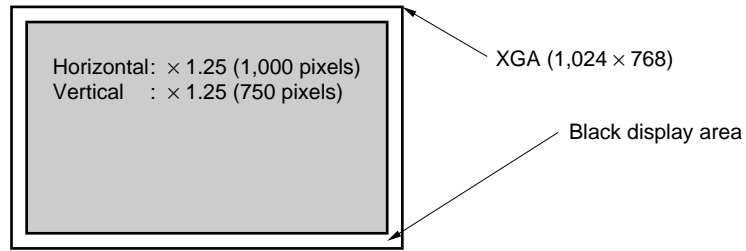

2) VGA mode (640 × 480)

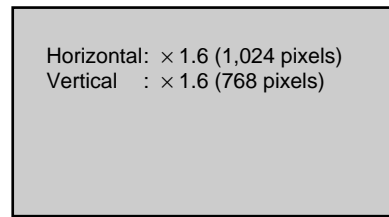

3) PC9801 mode (640 × 400)

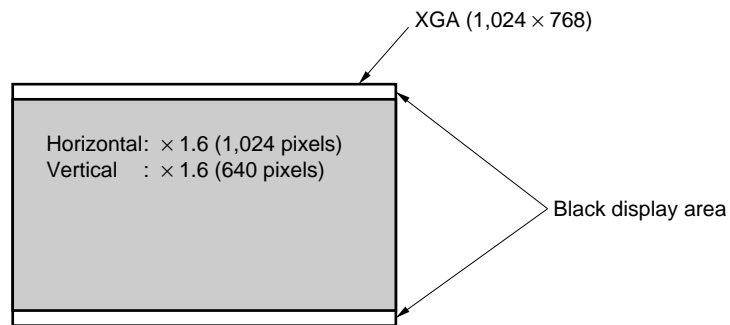

4) VGA text mode (720 × 400)

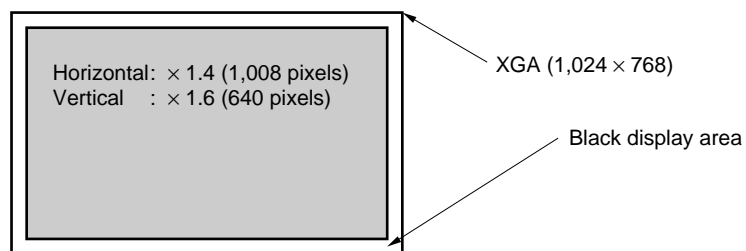

5) 832 × 624 MAC mode (832 × 624)

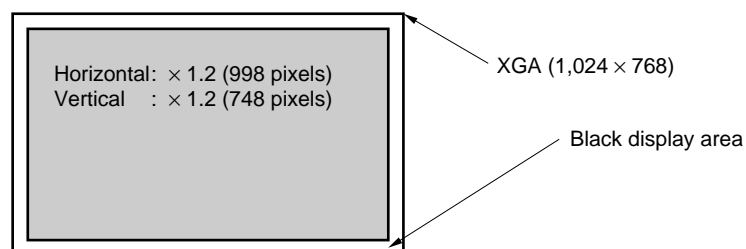



**(4) DDC FUNCTION**

This function is corresponding to VESA DDC™ and EDID™ (Structure Version 1).

- Writing mode : WPRT = “L”
- Reading mode: WPRT = “H” or Open

**Note** When the power is applied while RESET and UP are “L”, it becomes a writing mode. When the power is applied again, it becomes a reading mode. The mode set by RESET and UP signals is prioritized rather than WPRT signal after the power switched on.

Please write a data into necessary addresses in advance when you use this function. Data “55H” in address “00H” and “FFH” in other address are already programmed when shipping. The input equivalent circuit diagram is as follow.

www.DataSheet4U.com EDID: Extended Display Identification Data

**<Internal circuit diagram>**

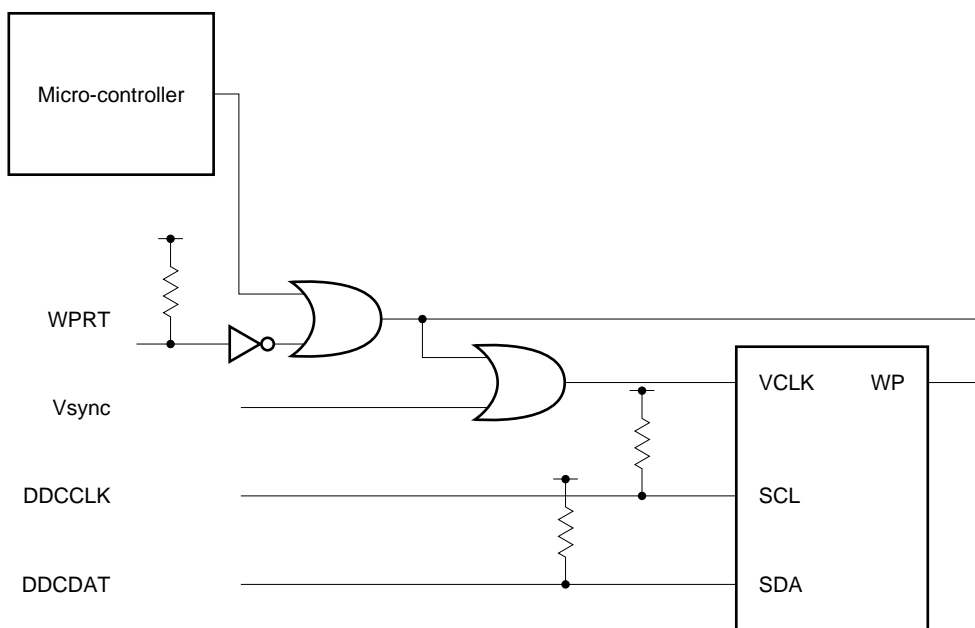

Product: Microchip Technology Inc.  
24LCS21  
or equivalent

**(5) DPMS**

VESA DPMS Standard						NL10276AC30-01A	
State	Signal			Power saving	Recovery time	Power saving	Recovery time
	Horizontal	Vertical	Video				
On	Pulses	Pulses	Active	None	Not applicable	None	Not applicable
Stand-by	No pulses	Pulses	Blanked	Minimum	Short	Maximum	Short
Suspend	Pulses	No pulses	Blanked	Substantial	Longer	Maximum	Short
Off	No pulses	No pulses	Blanked	Maximum	System dependent	Maximum	Short

**CONTROL FUNCTIONS**

- 1. Brightness (Luminance) : Control luminance of backlight
- 2. Contrast : Control white-level of video signal
- 3. Horizontal display period : Adjust horizontal display period
- 4. CLK delay : Adjust CLK-phase
- 5. Vertical position : Adjust vertical position
- 6. Horizontal position : Adjust horizontal position
- 7. ALL RESET : Reset to factory-default value

In order to achieve the best picture quality, the above functions should be adjusted by setting SEL, UP, DOWN and RESET signals. Either LED or OSD can recognize the selected functions. Each adjusted value is memorized as soon as SEL is selected or time out mode is valid and the memorized values are not affected even if the power is switched off. But the selected value is not memorized in case that a selected mode is changed to another one before time out or power is turned off before time out. Regarding the luminance, the luminance value can not be memorized while the variable volume register is selected.

This function does not work while the power save mode.

**(1) SELECTION BY LED**

The selected functions can be indicated either LED or OSD (On Screen Display) by setting OSDSEL signal when the power switched on.

OSDSEL = "H or OPEN": LED  
 OSDSEL = "L" : OSD

Please see the example of LED circuit on P 11.

Selection function	LED00	LED01	LED02	LED10	LED11	LED12
Default (no-select condition)	L	L	L	H	H	H
Luminance	H	L	L	L	H	H
Contrast	H	L	L	H	L	H
Horizontal display period	H	L	L	H	H	L
CLK delay	L	H	L	L	H	H
Vertical position	L	H	L	H	L	H
Horizontal position	L	H	L	H	H	L
Reserve (no-use)	L	L	H	L	H	H
All reset	L	L	H	H	L	H
Reserve (no-use)	L	L	H	H	H	L

**(2) SELECTION BY OSD**

The following pictures appear on the screen by pushing the SEL key. Adjust the each value in best position by pushing UP and DOWN key.

**1) Brightness (Luminance)**



**2) Contrast**



**3) Horizontal display period**



**4) CLK delay**



**5) Vertical display position**



**6) Horizontal display position**



**7) All reset**



(3) FLOW CHART OF CONTROL FUNCTIONS FOR SEL, UP, DOWN AND RESET

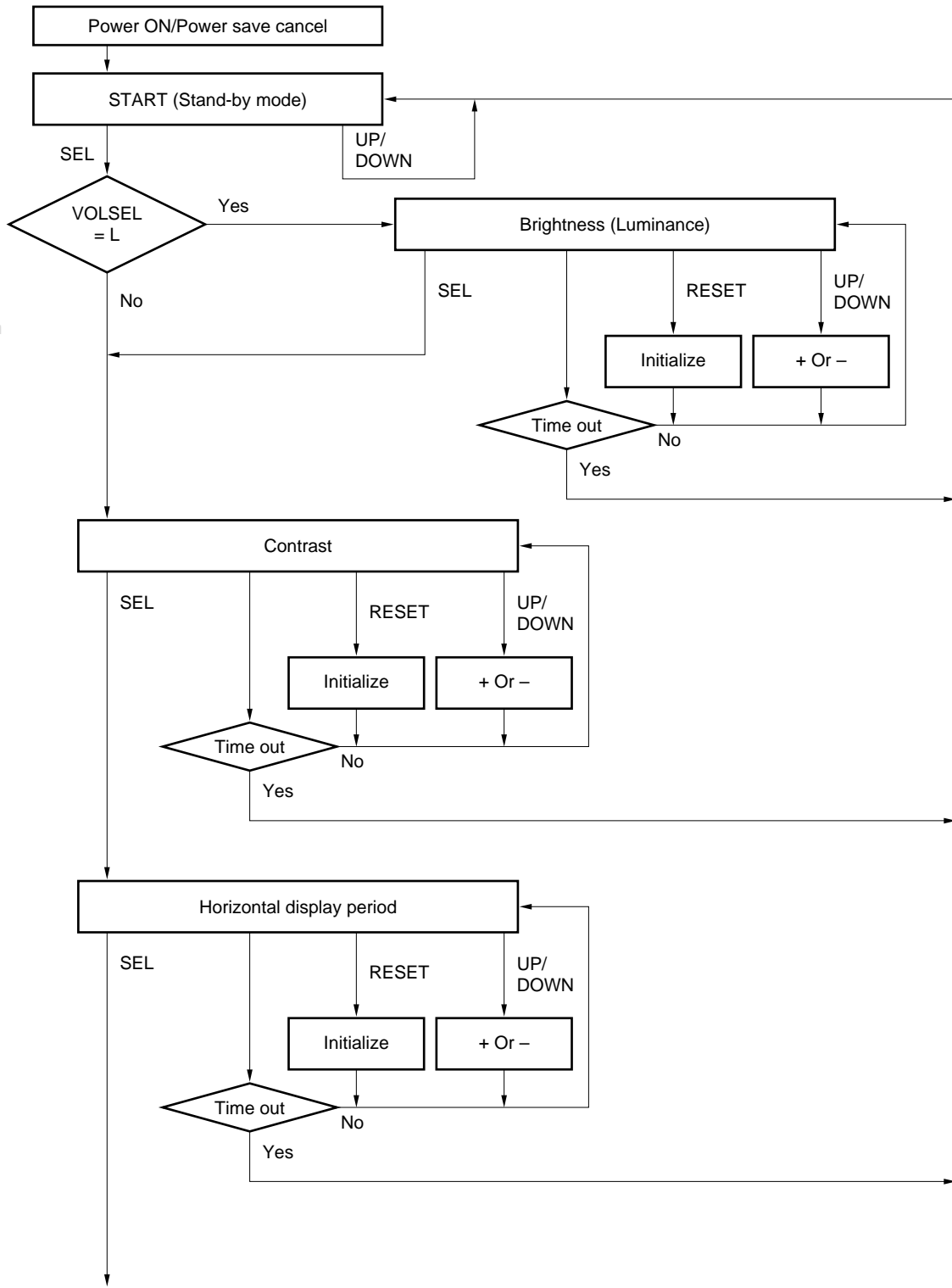

www.DataSheet4U.com

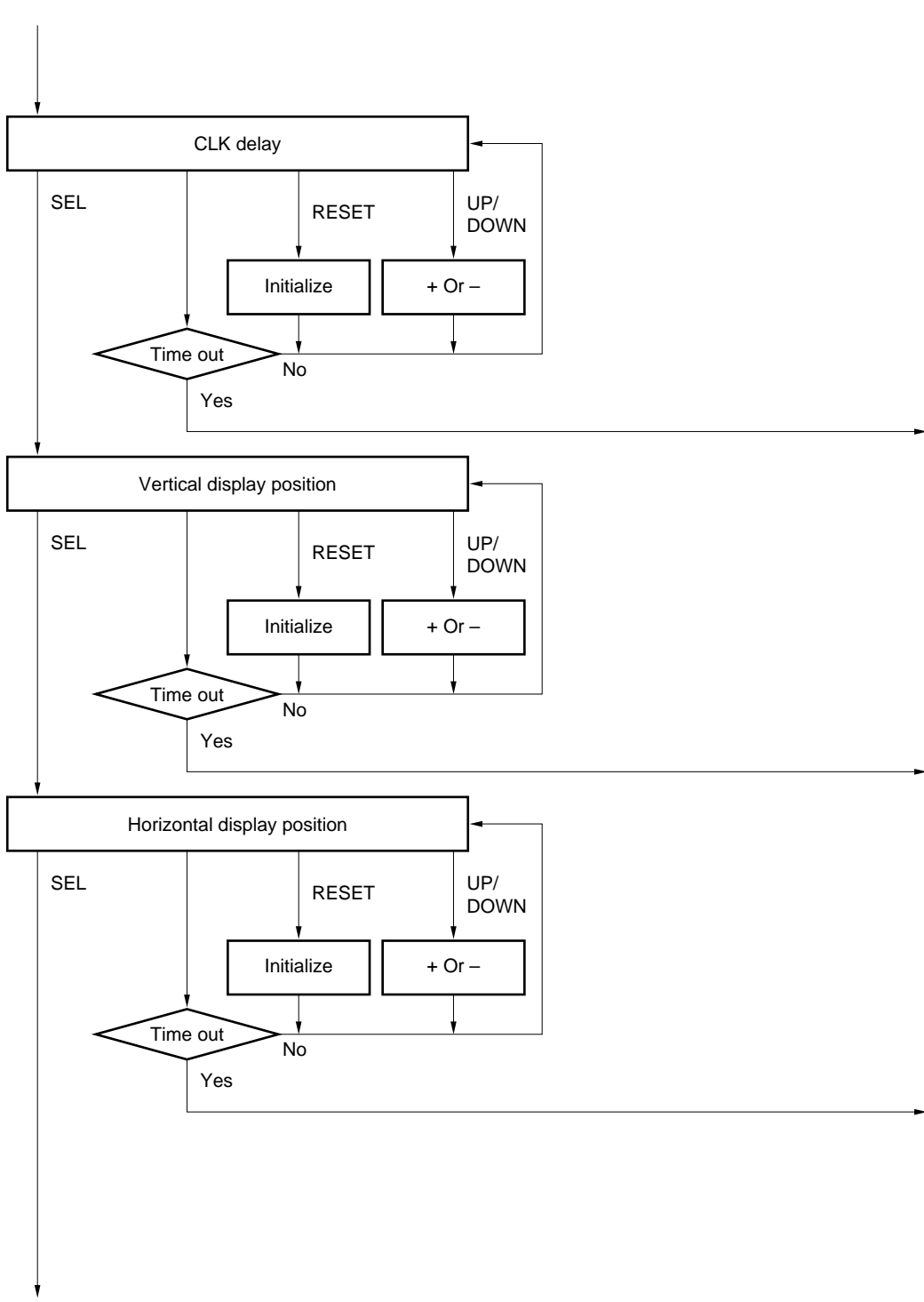

www.DataSheet4U.com

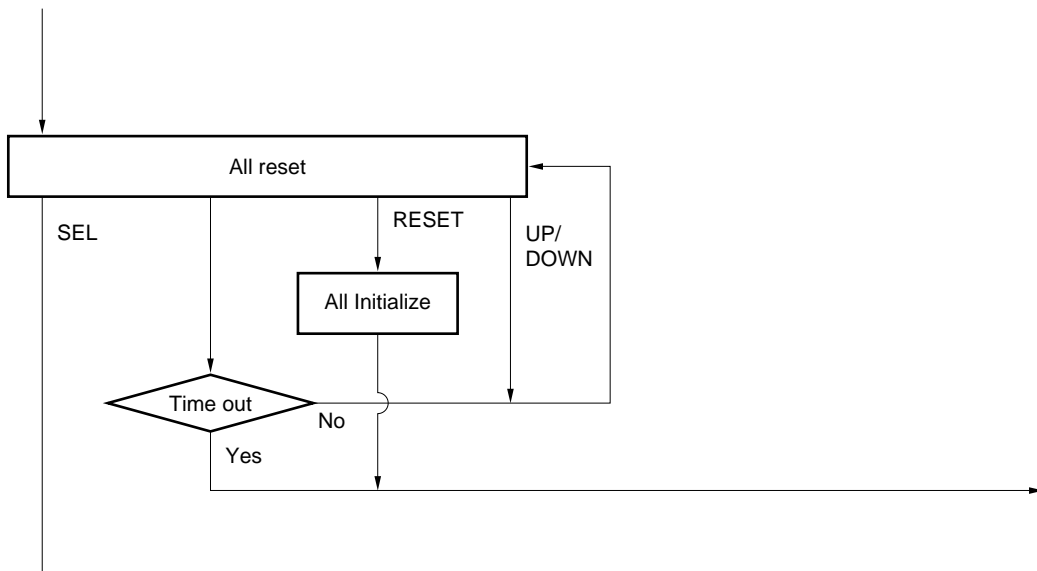

www.DataSheet4U.com

- Notes**
1. The value of the selected signals by UP and DOWN key is continuously incremented if the input signal is held more than approx. one second. If it's less than one second, the value is incremented by one.
  2. RESET signal initializes the value selected by SEL key. All reset function initializes all the values adjusted already. RESET signal should be held more than approx. two seconds.
  3. No key input for more than five seconds shall be regarded "Time out".

OPTICAL CHARACTERISTICS

(T<sub>a</sub> = 25°C, V<sub>DD</sub> = 12 V, V<sub>DDB</sub> = 12 V)

Item	Symbol	Condition	Min.	Typ.	Max.	Unit	Remarks
Contrast ratio	CR	$\gamma = 2.2$ viewing angle $\theta_R = 0^\circ, \theta_L = 0^\circ, \theta_D = 0^\circ$ , White/Black, at center	100	150	–	–	<b>Note 1</b>
Luminance	Lvmax	White, at center	150	180	–	cd/m <sup>2</sup>	<b>Note 2</b>
Luminance uniformity	–	White	–	1.1	1.30	–	<b>Note 3</b>

Reference data

(T<sub>a</sub> = 25°C, V<sub>DD</sub> = 12 V, V<sub>DDB</sub> = 12 V)

Item	Symbol	Condition	Min.	Typ.	Max.	Unit	Remark
Color gamut	C	$\theta_R = 0^\circ, \theta_L = 0^\circ, \theta_U = 0^\circ, \theta_D = 0^\circ$ at center, to NTSC	35	48	–	%	–
Viewing angle range	$\theta_R$	CR > 10, $\theta_U = 0^\circ, \theta_D = 0^\circ$	70	85	–	deg.	–
	$\theta_L$		70	85	–	deg.	–
	$\theta_U$	CR > 10, $\theta_R = 0^\circ, \theta_L = 0^\circ$	70	85	–	deg.	–
	$\theta_D$		70	85	–	deg.	–
Response time	ton	Black to White (0 % → 90%)	–	44	80	ms	<b>Note 5</b>
	toff	White to Black (100 % → 10%)	–	47	80		
Luminance control range	–	Maximum luminance: 100%	–	30 - 100	–	%	–

**Notes 1.** The contrast ratio is calculated using the following formula.

$$\text{Contrast ratio (CR)} = \frac{\text{Luminance with all pixels in "white"}}{\text{Luminance with all pixels in "black"}}$$

- The luminance is measured after 20 minutes from the module works, with all pixels in "white". The typical value is measured after luminance saturation, more than one hour after burn-in. The timing is XGA standard mode, preset No. 9

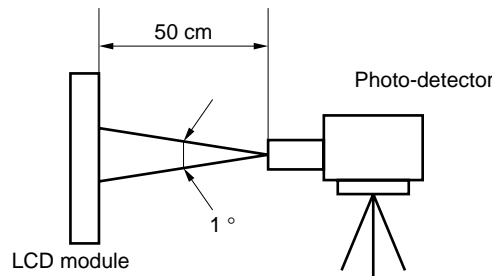

3. Luminance uniformity is calculated using the following formula.

$$\text{Luminance uniformity} = \frac{\text{Maximum luminance}}{\text{Minimum luminance}}$$

The luminance is measured at near the five points shown below.

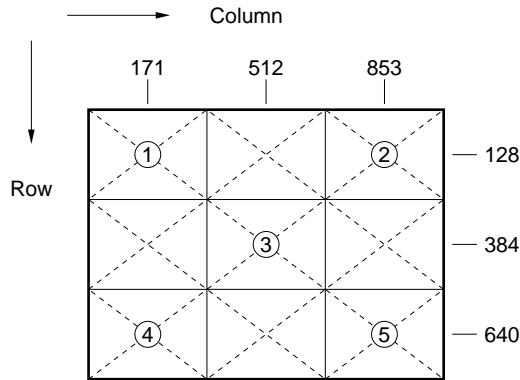

www.DataSheet4U.com

4. Definitions of viewing angle are as follows.

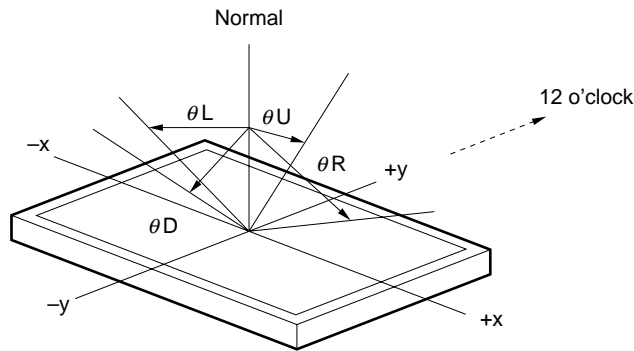

5. Definitions of response time is as follows.

Photo-detector output signal is measured when the luminance changes "white" to "black" or "black" to "white".

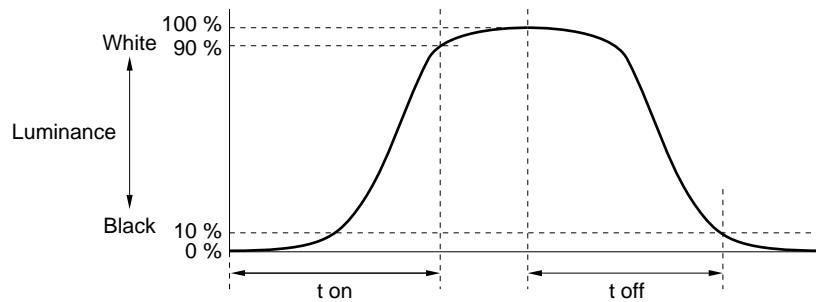



RELIABILITY TEST

Test item	Test condition	Judgment
High temperature/humidity operation	50 ±2°C, 85% relative humidity 240 hours, Display data is white.	<b>Note 1</b>
Heat cycle (operation)	<1> 0°C ±3°C ... 1 hour 55°C ±3°C ... 1 hour <2> 50 cycles, 4 hours/cycle <3> Display data is white.	<b>Note 1</b>
Thermal shock (non-operation)	<1> -20°C ±3°C ... 30 minutes 60°C ±3°C ... 30 minutes <2> 100 cycles <3> Temperature transition time is within 5 minutes.	<b>Note 1</b>
Vibration (non-operation)	<1> 5-100 Hz, 2 G 1 minute/cycle, X, Y, Z direction <2> 50 times each direction	<b>Notes 1, 2</b>
Mechanical shock (non-operation)	<1> 55 G, 11 ms X, Y, Z direction <2> 3 times each direction	<b>Notes 1, 2</b>
ESD (operation)	150 pF, 150 Ω, ±10 KV 9 places on a panel <b>Note 3</b> 10 times each place at one-second intervals	<b>Note 1</b>
Dust (operation)	15 kinds of dust (JIS Z 8901) Hourly 15 seconds stir, 8 times repeat	<b>Note 1</b>

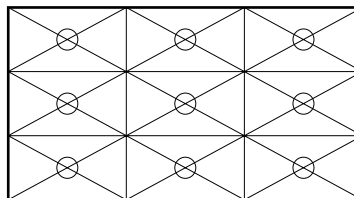

- Notes**
1. Display function is checked by the same condition as LCD module out-going inspection.
  2. Physical damage.
  3. Discharge points are shown in the figure.



**GENERAL CAUTIONS**

Next figures and sentence are very important. Please understand these contents as follows.

	<b>CAUTION</b>	This figure is a mark that you will get hurt and/or the module will have damages when you make a mistake to operate.
---	----------------	--

	This figure is a mark that you will get an electric shock when you make a mistake to operate.	
	This figure is a mark that you will get hurt when you make a mistake to operate	

 **CAUTION**

	Do not touch an inverter, on which is stuck a caution label, while the LCD module is under the operation, because of dangerous high voltage.
---	--

- (1) Caution when taking out the module
  - a) Pick the pouch only, in taking out module from a carrier box.
- (2) Cautions for handling the module
  - a) As the electrostatic discharges may break the LCD module, handle the LCD module with care against electrostatic discharges.
  - b)  As the LCD panel and backlight element are made from fragile glass material, impulse and pressure to the LCD module should be avoided.
  - c) As the surface of polarizer is very soft and easily scratched, use a soft dry cloth without chemicals for cleaning.
  - d) Do not pull the interface connectors in or out while the LCD module is operating.
  - e) Put the module display side down on a flat horizontal plane.
  - f) Handle connectors and cables with care.
  - g) When the module is operating, do not lose CLK, HS, or Vsync signal. If any one of these signals is lost, the LCD panel would be damaged.
  - h) The torque to mounting screw should never exceed 0.392 N·m (4 kgf·cm).
  - i) Don't push or rub the surface of LCD module please.  
If you do, the scratches or the marks like rubbing may left on the surface of the module.
- (3) Cautions for the atmosphere
  - a) Dew drop atmosphere should be avoided.
  - b) Do not store and/or operate the LCD module in a high temperature and/or high humidity atmosphere. Storage in an anti-static pouch and under the room temperature atmosphere is recommended.
  - c) This module uses cold cathode fluorescent lamps. Therefore, the life of lamps becomes short if the module is operated under the low temperature environment.
  - d) Do not operate the LCD module in a high magnetic field.
- (4) Caution for the module characteristics
  - a) Do not apply the fixed pattern for a long time to the LCD module. It may cause image sticking. Please use the screen savers if the display pattern is fixed for a long time.
  - b) This module has the retardation film which may cause the variation of the color hue in the different viewing angles. The nonuniformity may appear on the screen under the high temperature operation.
  - c) The light vertical stripe may be observed depending on the display pattern. This is not defects or malfunctions.

d) The noise from the inverter circuit may be observed in the luminance control mode. This is not defects or malfunctions.

(5) Other cautions

- a) Do not disassemble and/or reassemble LCD module.
- b) Do not readjust any variable resistors or switches in the module.
- c) When returning the module for repair or etc., please pack the module properly to avoid any damages. We recommend using the original shipping packages.
- d) In case that the scan converter is used to convert VGA signal to NTSC, it is recommended using the frame-memory type, not the line-memory.

Liquid Crystal Display has the following specific characteristics. There are not defects or malfunctions.

The optical characteristics of this module may be affected by the ambient temperature.

This module has cold cathode tube for backlight. Optical characteristics, like luminance or uniformity, will be changed by the progress in time.

Uneven brightness and/or small spots may be observed depending on different display patterns.



OUTLINE DRAWING: REAR VIEW (Unit: mm)

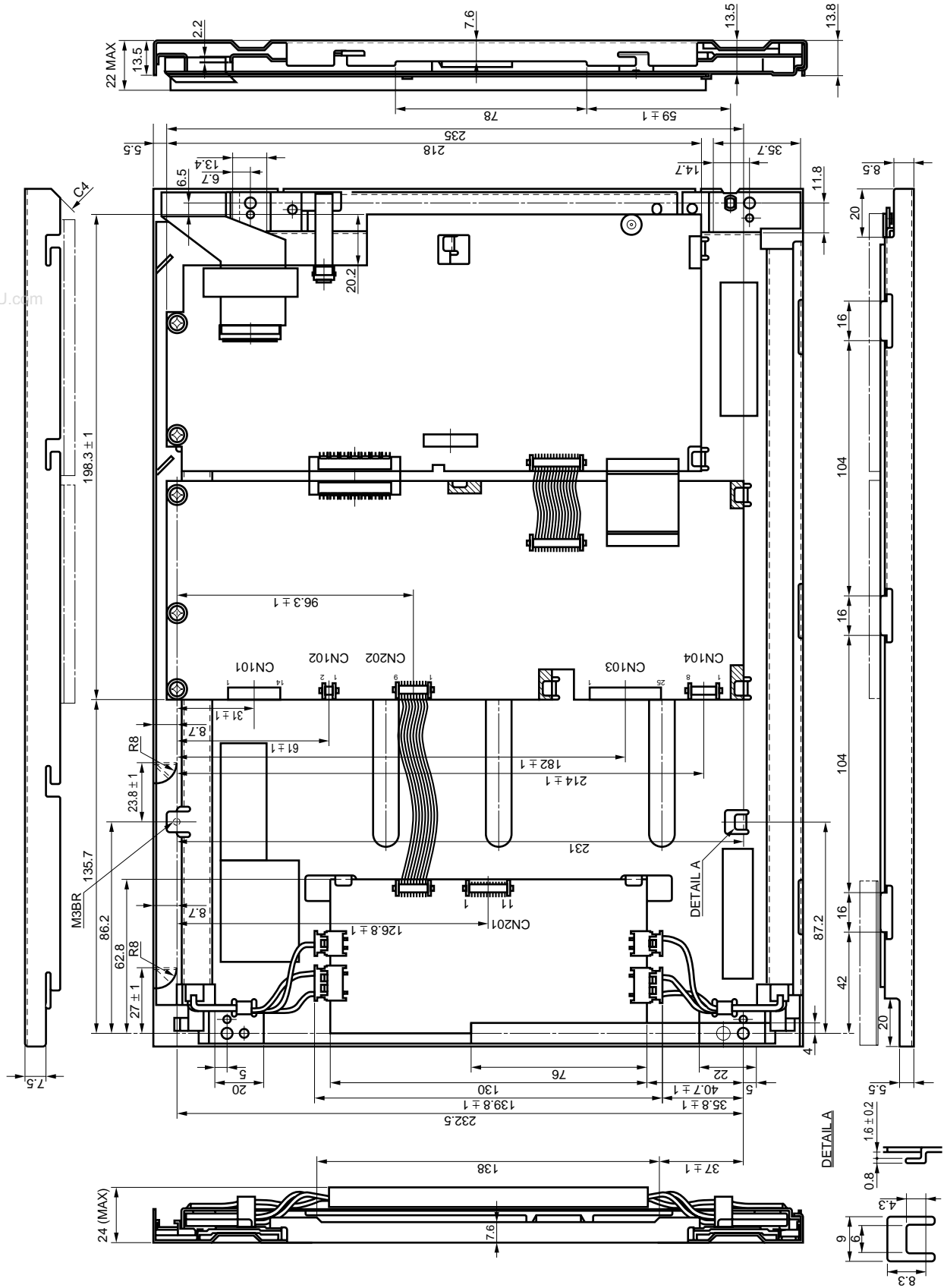

[MEMO]

www.DataSheet4U.com

[MEMO]

www.DataSheet4U.com

No part of this document may be copied or reproduced in any form or by any means without the prior written consent of NEC Corporation. NEC Corporation assumes no responsibility for any errors which may appear in this document.

NEC Corporation does not assume any liability for infringement of patents. Copyrights or other intellectual property rights of third parties by or arising from use of a device described herein or any other liability arising from use of such device. No license, either express, implied or otherwise, is granted under any patents, copyrights or other intellectual property rights of NEC Corporation or others.

While NEC Corporation has been making continuous effort to enhance the reliability of its Electronic components, the possibility of defects cannot be eliminated entirely. To minimize risks of damage or injury to persons or property arising from a defect in an NEC electronic components, customers must incorporate sufficient safety measures in its design, such as redundancy, fire-containment, and anti-failure features.

NEC devices are classified into the following three quality grades:

“Standard”, “Special”, and “Specific”. The Specific quality grade applies only to devices developed based on a customer designated “quality assurance program” for a specific application. The recommended applications of a device depend on its quality grade, as indicated below. Customers must check the quality grade of each device before using it in a particular application.

**Standard:** Computers, office equipment, communications equipment, test and measurement equipment, audio and visual equipment, home electronic appliances, machine tools, personal electronic equipment and industrial robots

**Special:** Transportation equipment (automobiles, trains, ships, etc.), traffic control systems, anti-disaster systems, anti-crime systems, safety equipment and medical equipment (not specifically designed for life support)

**Specific:** Aircrafts, aerospace equipment, submersible repeaters, nuclear reactor control systems, life support systems or medical equipment for life support, etc.

The quality grade of NEC devices is “Standard” unless otherwise specified in NEC’s Data Sheets or Data Books. If customers intend to use NEC devices for applications other than those specified for Standard quality grade, they should contact an NEC sales representative in advance.

Anti-radioactive design is not implemented in this product.