

## 13 mm Seven Segment Display

Color	Type	Circuitry
Red	TDSR515.	Common anode
Red	TDSR516.	Common cathode
Orange red	TDSO515.	Common anode
Orange red	TDSO516.	Common cathode
Yellow	TDSY515.	Common anode
Yellow	TDSY516.	Common cathode
Green	TDSG515.	Common anode
Green	TDSG516.	Common cathode

### Description

The TDS.51.. series are 13 mm character seven segment LED displays in a very compact package. The displays are designed for a viewing distance up to 7 meters and available in four bright colors. The grey package surface and the evenly lighted untinted segments provide an optimum on-off contrast. All displays are categorized in luminous intensity groups. That allows users to assemble displays with uniform appearance. Typical applications include instruments, panel meters, point-of-sale terminals and household equipment.

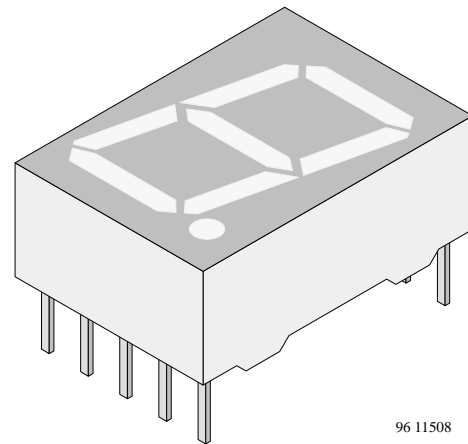

96 11508

### Features

- Evenly lighted segments
- Grey package surface
- Untinted segments
- Luminous intensity categorized
- Yellow and green categorized for color
- Wide viewing angle
- Suitable for DC and high peak current

### Applications

Panel meters  
Test- and measure- equipment  
Point-of-sale terminals  
Control units  
TV sets

## Absolute Maximum Ratings

$T_{amb} = 25^{\circ}\text{C}$ , unless otherwise specified

TDSR515./TDSR516. , TDSO515./TDSO516. , TDSY515./TDSY516. , TDSG515./TDSG516. , /

Parameter	Test Conditions	Type	Symbol	Value	Unit
Reverse voltage per segment or DP			$V_R$	6	V
DC forward current per segment or DP		TDSR315./316.	$I_F$	35	mA
		TDSO315./316.	$I_F$	25	mA
		TDSY315./316.	$I_F$	25	mA
		TDSG315./316.	$I_F$	25	mA
Surge forward current per segment or DP	$t_p \leq 10 \mu\text{s}$ (non repetitive)	TDSR315./316.	$I_{FSM}$	0.5	A
		TDSO315./316.	$I_{FSM}$	0.15	A
		TDSY315./316.	$I_{FSM}$	0.15	A
		TDSG315./316.	$I_{FSM}$	0.15	A
Power dissipation	$T_{amb} \leq 45^{\circ}\text{C}$		$P_V$	550	mW
Junction temperature			$T_j$	100	$^{\circ}\text{C}$
Operating temperature range			$T_{amb}$	-40 to + 85	$^{\circ}\text{C}$
Storage temperature range			$T_{stg}$	-40 to + 85	$^{\circ}\text{C}$
Soldering temperature	$t \leq 3 \text{ sec}$ , 2mm below seating plane		$T_{sd}$	260	$^{\circ}\text{C}$
Thermal resistance LED junction/ambient			$R_{thJA}$	100	K/W

## Optical and Electrical Characteristics

$T_{amb} = 25^{\circ}\text{C}$ , unless otherwise specified

Red (TDSR515. , TDSR516. )

Parameter	Test Conditions	Type	Symbol	Min	Typ	Max	Unit
Luminous intensity per segment (digit average) <sup>1)</sup>	$I_F = 10 \text{ mA}$	TDSR 5150/5160	$I_V$	280			$\mu\text{cd}$
Dominant wavelength	$I_F = 10 \text{ mA}$		$\lambda_d$		655		nm
Peak wavelength	$I_F = 10 \text{ mA}$		$\lambda_p$		660		nm
Angle of half intensity	$I_F = 10 \text{ mA}$		$\phi$		$\pm 50$		deg
Forward voltage per segment or DP	$I_F = 20 \text{ mA}$		$V_F$		1.6	2	V
Reverse voltage per segment or DP	$I_R = 10 \mu\text{A}$		$V_R$	6	15		V
<sup>1)</sup> $I_{Vmin}$ and $I_V$ groups are mean	values of segments a to g						



**Orange red (TDSO515. , TDSO516. )**

Parameter	Test Conditions	Type	Symbol	Min	Typ	Max	Unit
Luminous intensity per segment (digit average) <sup>1)</sup>	$I_F = 10 \text{ mA}$	TDSO 5150/5160	$I_V$	700			$\mu\text{cd}$
Dominant wavelength	$I_F = 10 \text{ mA}$		$\lambda_d$	612		625	nm
Peak wavelength	$I_F = 10 \text{ mA}$		$\lambda_p$		630		nm
Angle of half intensity	$I_F = 10 \text{ mA}$		$\phi$		$\pm 50$		deg
Forward voltage per segment or DP	$I_F = 20 \text{ mA}$		$V_F$		2	3	V
Reverse voltage per segment or DP	$I_R = 10 \mu\text{A}$		$V_R$	6	15		V
<sup>1)</sup> $I_{V_{\min}}$ and $I_V$ groups are mean	values of segments a to g						

**Yellow (TDSY515. , TDSY516. )**

Parameter	Test Conditions	Type	Symbol	Min	Typ	Max	Unit
Luminous intensity per segment (digit average) <sup>1)</sup>	$I_F = 10 \text{ mA}$	TDSY 5150/5160	$I_V$	700			$\mu\text{cd}$
Dominant wavelength	$I_F = 10 \text{ mA}$		$\lambda_d$	581		594	nm
Peak wavelength	$I_F = 10 \text{ mA}$		$\lambda_p$		585		nm
Angle of half intensity	$I_F = 10 \text{ mA}$		$\phi$		$\pm 50$		deg
Forward voltage per segment or DP	$I_F = 20 \text{ mA}$		$V_F$		2.4	3	V
Reverse voltage per segment or DP	$I_R = 10 \mu\text{A}$		$V_R$	6	15		V
<sup>1)</sup> $I_{V_{\min}}$ and $I_V$ groups are mean	values of segments a to g						

**Green (TDSG515. , TDSG516. )**

Parameter	Test Conditions	Type	Symbol	Min	Typ	Max	Unit
Luminous intensity per segment (digit average) <sup>1)</sup>	$I_F = 10 \text{ mA}$	TDSG 5150/5160	$I_V$	700			$\mu\text{cd}$
Dominant wavelength	$I_F = 10 \text{ mA}$		$\lambda_d$	562		575	nm
Peak wavelength	$I_F = 10 \text{ mA}$		$\lambda_p$		565		nm
Angle of half intensity	$I_F = 10 \text{ mA}$		$\phi$		$\pm 50$		deg
Forward voltage per segment or DP	$I_F = 20 \text{ mA}$		$V_F$		2.4	3	V
Reverse voltage per segment or DP	$I_R = 10 \mu\text{A}$		$V_R$	6	15		V
<sup>1)</sup> $I_{V_{\min}}$ and $I_V$ groups are mean	values of segments a to g						

Typical Characteristics ( $T_{amb} = 25^{\circ}C$ , unless otherwise specified)

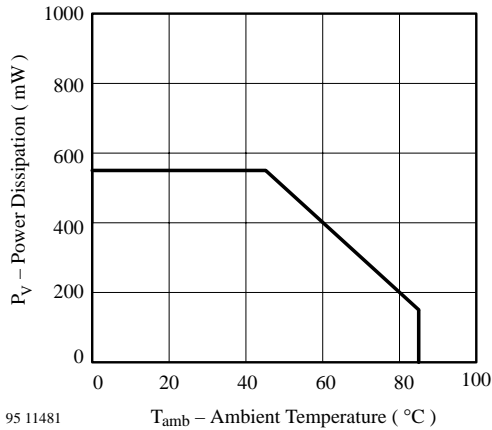

95 11481  $T_{amb}$  – Ambient Temperature ( $^{\circ}C$ )  
Figure 1. Power Dissipation vs. Ambient Temperature

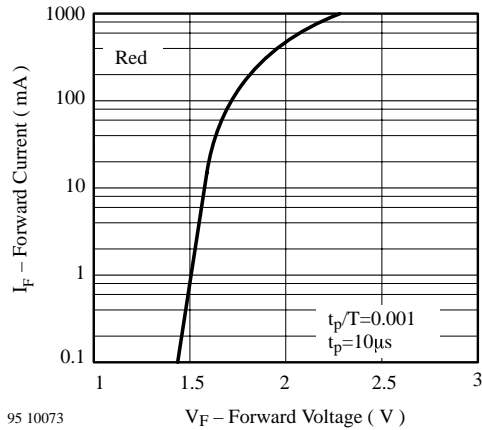

95 10073  $V_F$  – Forward Voltage (V)  
Figure 4. Forward Current vs. Forward Voltage

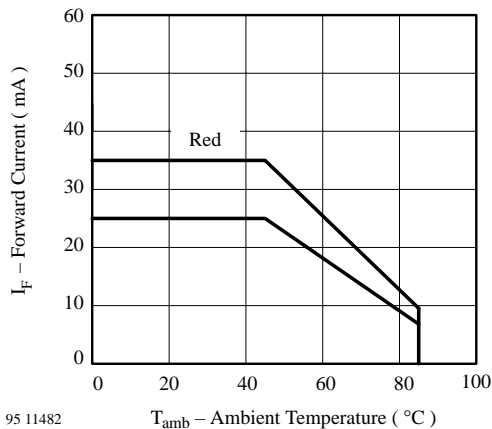

95 11482  $T_{amb}$  – Ambient Temperature ( $^{\circ}C$ )  
Figure 2. Forward Current vs. Ambient Temperature

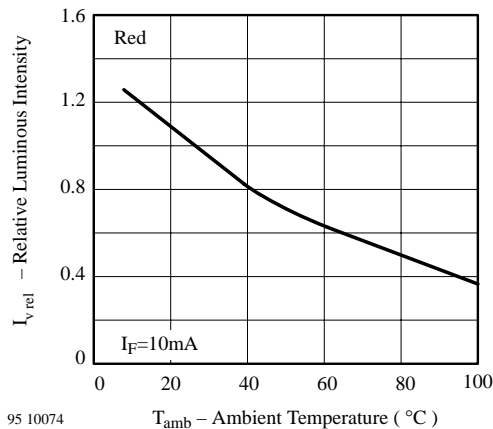

95 10074  $T_{amb}$  – Ambient Temperature ( $^{\circ}C$ )  
Figure 5. Rel. Luminous Intensity vs. Ambient Temperature

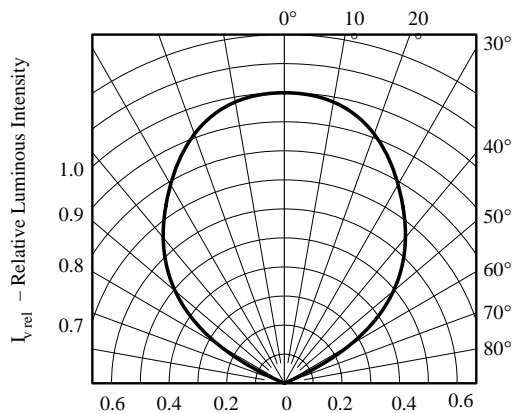

95 10082  
Figure 3. Rel. Luminous Intensity vs. Angular Displacement

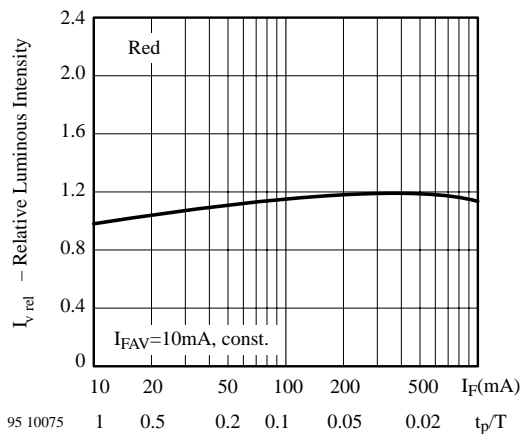

95 10075  $I_F$ (mA)  
Figure 6. Rel. Lumin. Intensity vs. Forw. Current/Duty Cycle

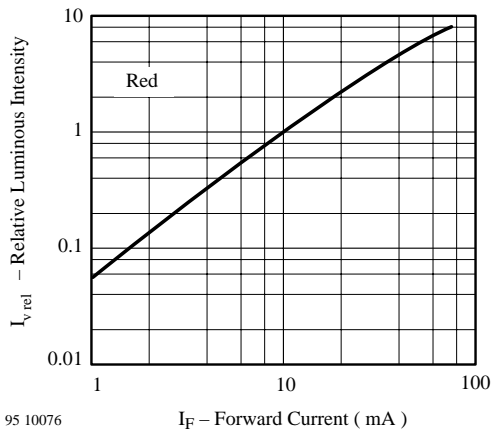

95 10076  
Figure 7. Relative Luminous Intensity vs. Forward Current

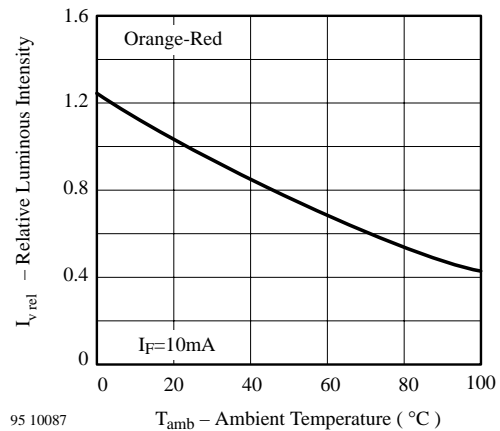

95 10087  
Figure 10. Rel. Luminous Intensity vs. Ambient Temperature

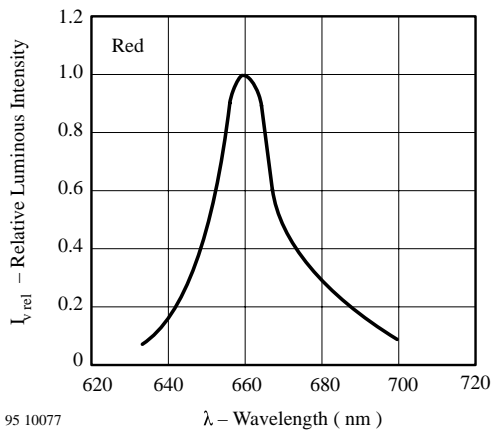

95 10077  
Figure 8. Relative Luminous Intensity vs. Wavelength

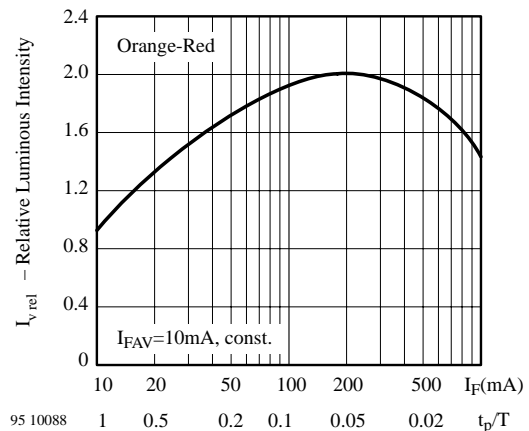

95 10088  
Figure 11. Rel. Lumin. Intensity vs. Forw. Current/Duty Cycle

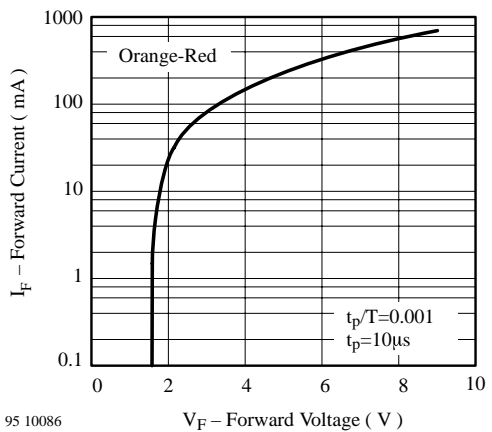

95 10086  
Figure 9. Forward Current vs. Forward Voltage

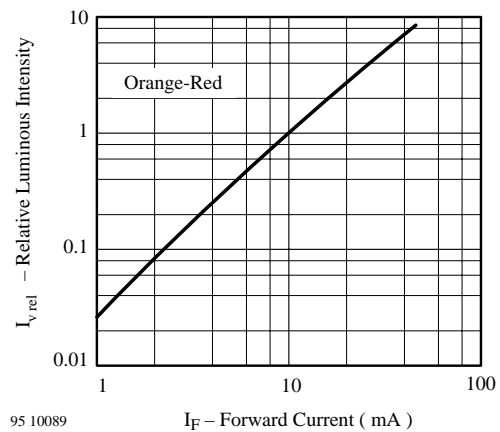

95 10089  
Figure 12. Relative Luminous Intensity vs. Forward Current

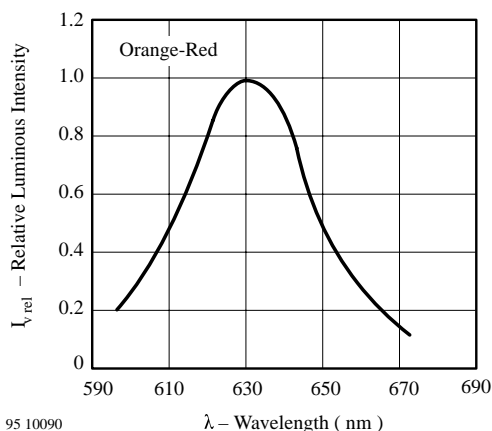

Figure 13. Relative Luminous Intensity vs. Wavelength

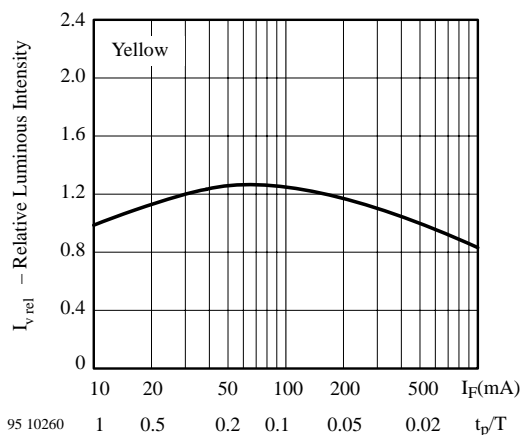

Figure 16. Rel. Lumin. Intensity vs. Forw. Current/Duty Cycle

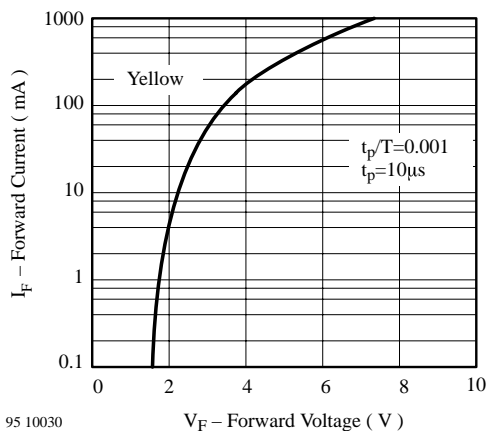

Figure 14. Forward Current vs. Forward Voltage

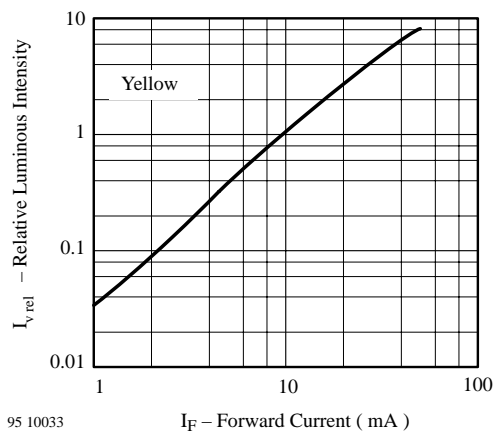

Figure 17. Relative Luminous Intensity vs. Forward Current

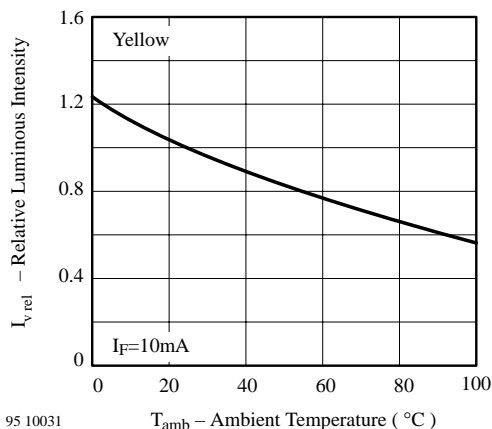

Figure 15. Rel. Luminous Intensity vs. Ambient Temperature

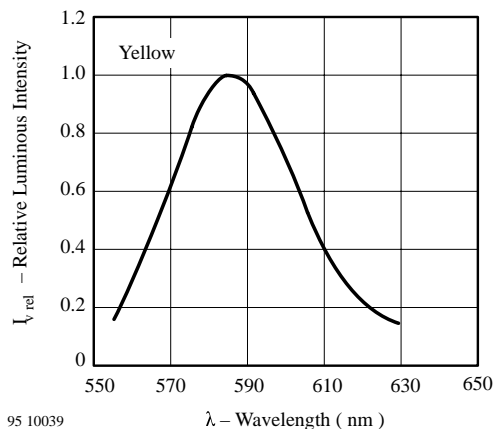

Figure 18. Relative Luminous Intensity vs. Wavelength

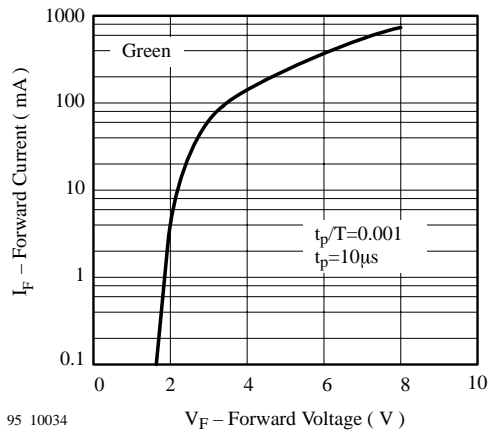

Figure 19. Forward Current vs. Forward Voltage

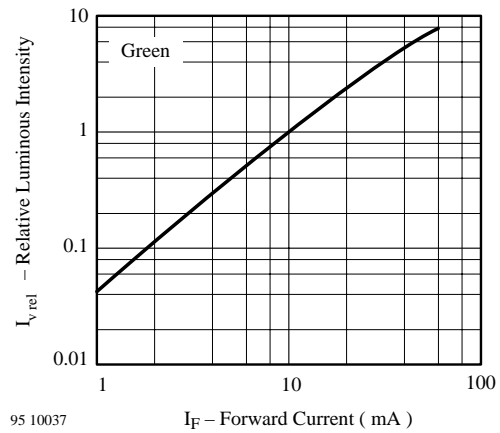

Figure 22. Relative Luminous Intensity vs. Forward Current

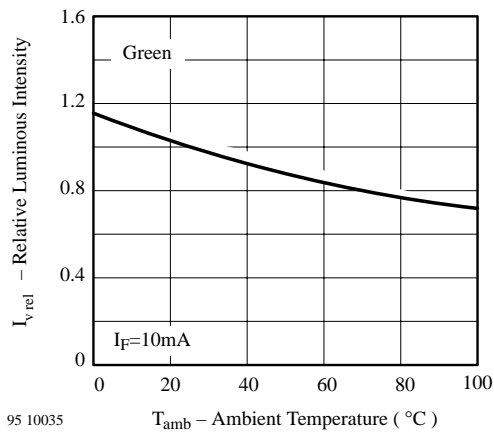

Figure 20. Rel. Luminous Intensity vs. Ambient Temperature

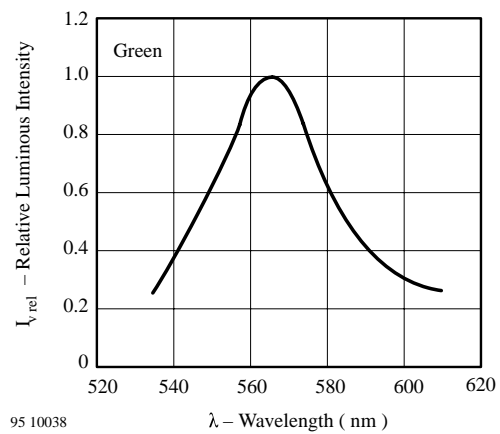

Figure 23. Relative Luminous Intensity vs. Wavelength

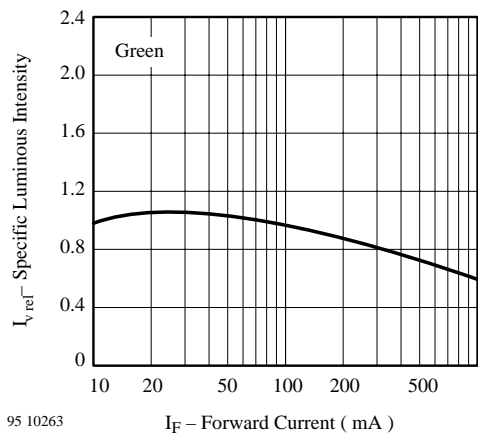
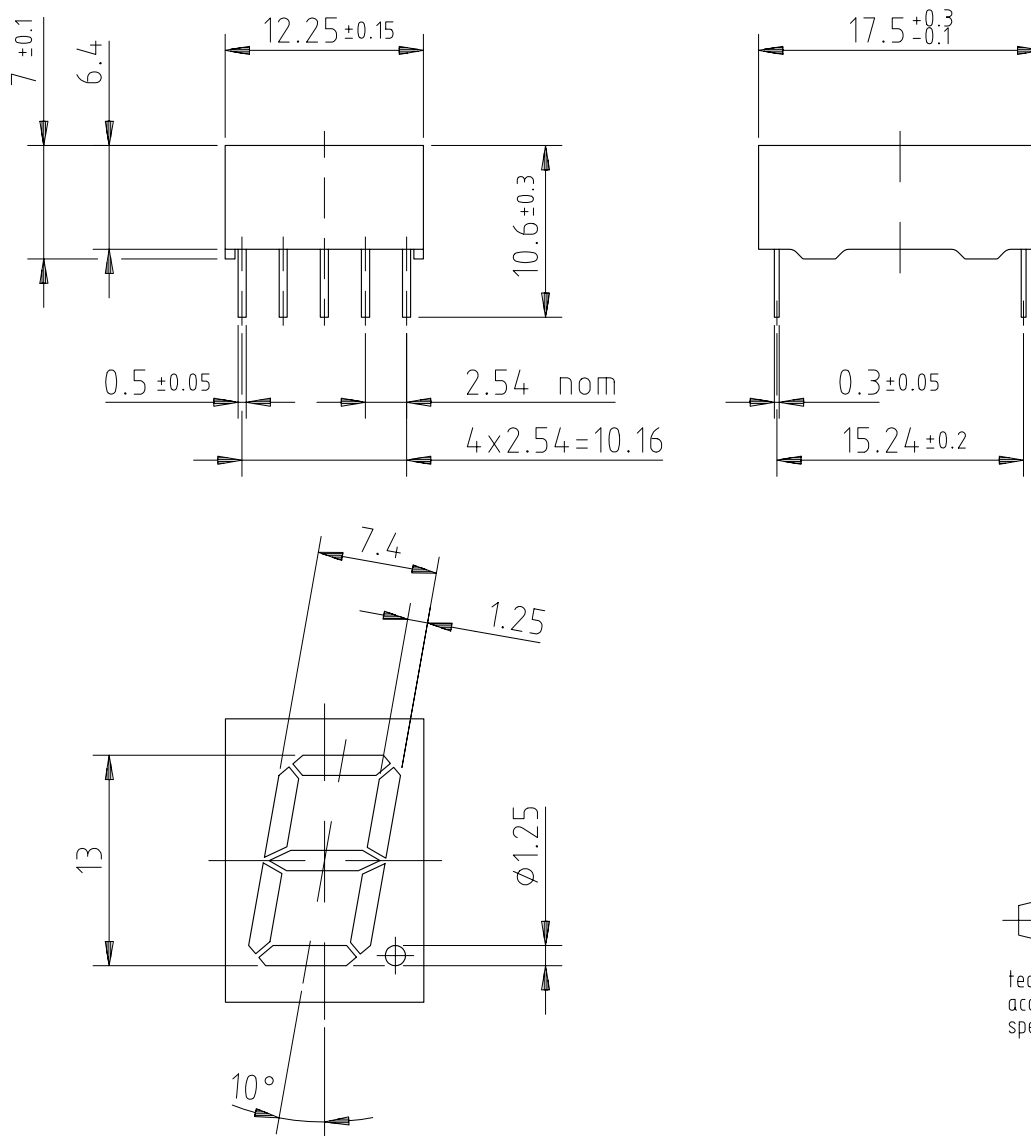
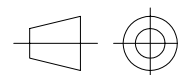

Figure 21. Specific Luminous Intensity vs. Forward Current

### Dimensions in mm



95 11344



technical drawings  
according to DIN  
specifications



**Pin connections**

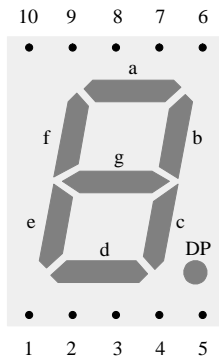

- 1 e
- 2 d
- 3 A (K)
- 4 c
- 5 DP
- 6 b
- 7 a
- 8 A (K)
- 9 f
- 10 g

95 10896

### Ozone Depleting Substances Policy Statement

It is the policy of **Vishay Semiconductor GmbH** to

1. Meet all present and future national and international statutory requirements.
2. Regularly and continuously improve the performance of our products, processes, distribution and operating systems with respect to their impact on the health and safety of our employees and the public, as well as their impact on the environment.

It is particular concern to control or eliminate releases of those substances into the atmosphere which are known as ozone depleting substances (ODSs).

The Montreal Protocol (1987) and its London Amendments (1990) intend to severely restrict the use of ODSs and forbid their use within the next ten years. Various national and international initiatives are pressing for an earlier ban on these substances.

**Vishay Semiconductor GmbH** has been able to use its policy of continuous improvements to eliminate the use of ODSs listed in the following documents.

1. Annex A, B and list of transitional substances of the Montreal Protocol and the London Amendments respectively
2. Class I and II ozone depleting substances in the Clean Air Act Amendments of 1990 by the Environmental Protection Agency (EPA) in the USA
3. Council Decision 88/540/EEC and 91/690/EEC Annex A, B and C (transitional substances) respectively.

**Vishay Semiconductor GmbH** can certify that our semiconductors are not manufactured with ozone depleting substances and do not contain such substances.

**We reserve the right to make changes to improve technical design and may do so without further notice.**

Parameters can vary in different applications. All operating parameters must be validated for each customer application by the customer. Should the buyer use Vishay-Telefunken products for any unintended or unauthorized application, the buyer shall indemnify Vishay-Telefunken against all claims, costs, damages, and expenses, arising out of, directly or indirectly, any claim of personal damage, injury or death associated with such unintended or unauthorized use.

Vishay Semiconductor GmbH, P.O.B. 3535, D-74025 Heilbronn, Germany  
Telephone: 49 (0) 7131 67 2831, Fax number: 49 (0) 7131 67 2423