

## FEATURES

www.datasheet4u.com

- **Sample Rate: 105MSPS/80MSPS**
- **68dB SNR up to 140MHz Input**
- **80dB SFDR up to 170MHz Input**
- **775MHz Full Power Bandwidth S/H**
- **Single 3.3V Supply**
- **Low Power Dissipation: 475mW/366mW**
- Selectable Input Ranges:  $\pm 0.5V$  or  $\pm 1V$
- No Missing Codes
- Optional Clock Duty Cycle Stabilizer
- Shutdown and Nap Modes
- Data Ready Output Clock
- Pin Compatible Family
  - 135MSPS: LTC2224 (12-Bit), LTC2234 (10-Bit)
  - 105MSPS: LTC2222 (12-Bit), LTC2232 (10-Bit)
  - 80MSPS: LTC2223 (12-Bit), LTC2233 (10-Bit)
- 48-Pin QFN Package

## APPLICATIONS

- Wireless and Wired Broadband Communication
- Cable Head-End Systems
- Power Amplifier Linearization
- Communications Test Equipment

## DESCRIPTION

The LTC<sup>®</sup>2222 and LTC2223 are 105MSPS/80MSPS, sampling 12-bit A/D converters designed for digitizing high frequency, wide dynamic range signals. The LTC2222/LTC2223 are perfect for demanding communications applications with AC performance that includes 68dB SNR and 80dB spurious free dynamic range for signals up to 170MHz. Ultralow jitter of 0.15ps<sub>RMS</sub> allows undersampling of IF frequencies with excellent noise performance.

DC specs include  $\pm 0.3\text{LSB INL}$  (typ),  $\pm 0.2\text{LSB DNL}$  (typ) and no missing codes over temperature. The transition noise is a low 0.5LSB<sub>RMS</sub>.

A separate output power supply allows the outputs to drive 0.5V to 3.6V logic.

The ENC<sup>+</sup> and ENC<sup>-</sup> inputs may be driven differentially or single ended with a sine wave, PECL, LVDS, TTL, or CMOS inputs. An optional clock duty cycle stabilizer allows high performance at full speed for a wide range of clock duty cycles.

LTC, LTC and LT are registered trademarks of Linear Technology Corporation. All other trademarks are the property of their respective owners.

## TYPICAL APPLICATION

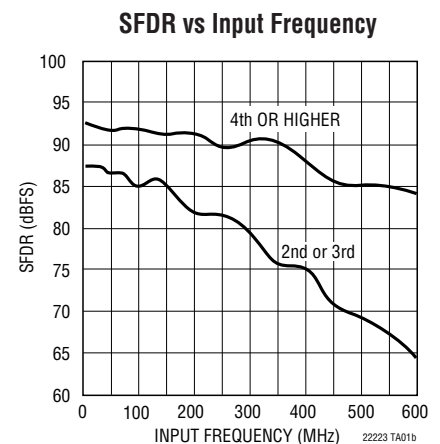
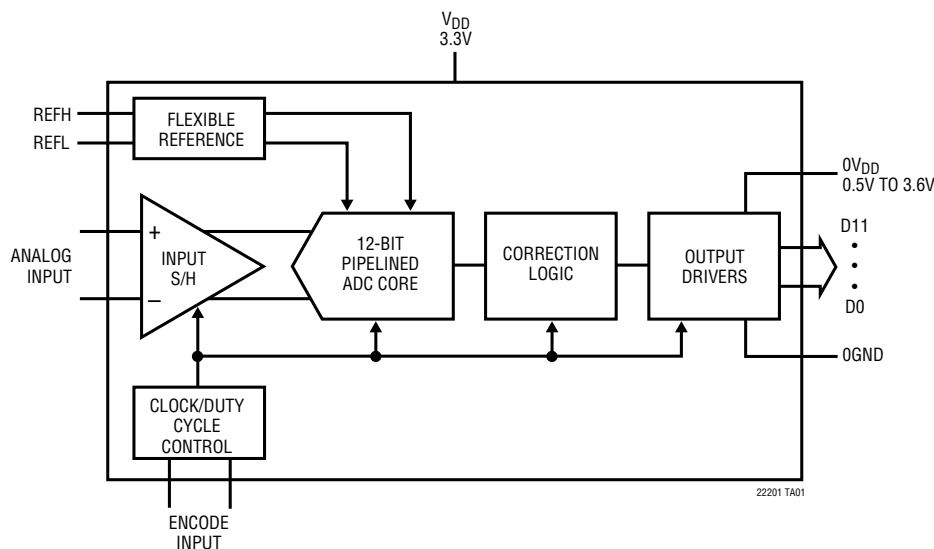

22223fa

# LTC2222/LTC2223

## ABSOLUTE MAXIMUM RATINGS

$OV_{DD} = V_{DD}$  (Notes 1, 2)

Supply Voltage ( $V_{DD}$ )	4V
Digital Output Ground Voltage (OGND)	-0.3V to 1V
Analog Input Voltage (Note 3)	-0.3V to ( $V_{DD} + 0.3V$ )
Digital Input Voltage	-0.3V to ( $V_{DD} + 0.3V$ )
Digital Output Voltage	-0.3V to ( $OV_{DD} + 0.3V$ )
Power Dissipation	1500mW
Operating Temperature Range	
LTC2222C, LTC2223C	0°C to 70°C
LTC2222I, LTC2223I	-40°C to 85°C
Storage Temperature Range	-65°C to 125°C

## PACKAGE/ORDER INFORMATION

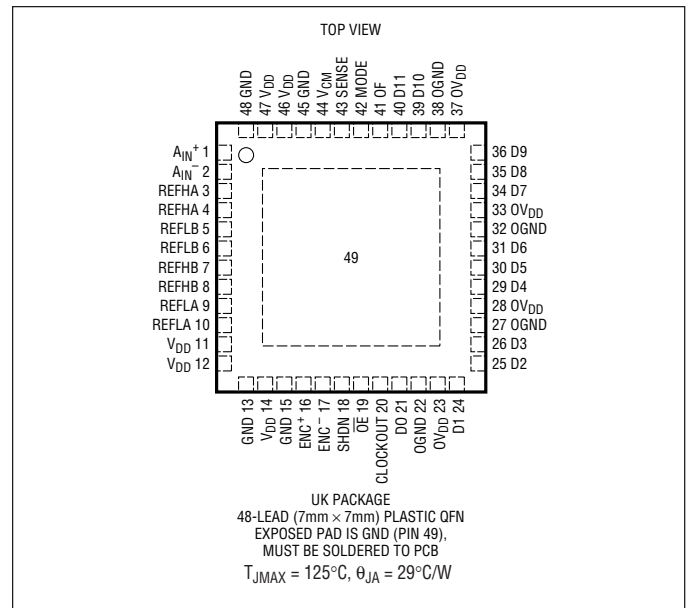

ORDER PART NUMBER	UK PART MARKING*
LTC2222CUK	LTC2222UK
LTC2223CUK	LTC2223UK
LTC2222IUK	LTC2222UK
LTC2223IUK	LTC2223UK

**Order Options** Tape and Reel: Add #TR  
Lead Free: Add #PBF Lead Free Tape and Reel: Add #TRPBF  
Lead Free Part Marking: <http://www.linear.com/leadfree/>

\*The temperature grade is identified by a label on the shipping container. Consult LTC Marketing for parts specified with wider operating temperature ranges.

## CONVERTER CHARACTERISTICS

The ● denotes the specifications which apply over the full operating temperature range, otherwise specifications are at  $T_A = 25^{\circ}C$ . (Note 4)

PARAMETER	CONDITIONS		LTC2222			LTC2223			UNITS
			MIN	TYP	MAX	MIN	TYP	MAX	
Resolution (No Missing Codes)		●	12			12			Bits
Integral Linearity Error (Note 5)	Differential Analog Input	●	-1.3	±0.3	1.3	-1.1	±0.3	1.1	LSB
Differential Linearity Error	Differential Analog Input	●	-1	±0.2	1	-0.8	±0.2	0.8	LSB
Integral Linearity Error (Note 5)	Single-Ended Analog Input			±1			±1		LSB
Differential Linearity Error	Single-Ended Analog Input			±0.2			±0.2		LSB
Offset Error (Note 6)		●	-30	±3	30	-30	±3	30	mV
Gain Error	External Reference	●	-2.5	±0.5	2.5	-2.5	±0.5	2.5	%FS
Offset Drift				±10			±10		μV/C
Full-Scale Drift	Internal Reference			±30			±30		ppm/C
	External Reference			±15			±15		ppm/C
Transition Noise	SENSE = 1V			0.5			0.5		LSB <sub>RMS</sub>

22223fa

## ANALOG INPUT

The ● denotes the specifications which apply over the full operating temperature range, otherwise specifications are at  $T_A = 25^\circ\text{C}$ . (Note 4)

SYMBOL	PARAMETER	CONDITIONS		MIN	TYP	MAX	UNITS
$V_{IN}$	Analog Input Range ( $A_{IN}^+ - A_{IN}^-$ )	$3.1V < V_{DD} < 3.5V$	●	$\pm 0.5$ to $\pm 1$			V
$V_{IN, CM}$	Analog Input Common Mode ( $(A_{IN}^+ + A_{IN}^-)/2$ )	Differential Input	●	1	1.6	1.9	V
		Single Ended Input (Note 7)	●	0.5	1.6	2.1	V
$I_{IN}$	Analog Input Leakage Current	$0 < A_{IN}^+, A_{IN}^- < V_{DD}$	●	-1		1	$\mu\text{A}$
$I_{SENSE}$	SENSE Input Leakage	$0V < SENSE < 1V$	●	-1		1	$\mu\text{A}$
$I_{MODE}$	MODE Pin Pull-Down Current to GND				10		$\mu\text{A}$
	Full Power Bandwidth	Figure 8 Test Circuit			775		MHz
$t_{AP}$	Sample and Hold Acquisition Delay Time				0		ns
$t_{JITTER}$	Sample and Hold Acquisition Delay Time Jitter				0.15		$\text{pSRMS}$
CMRR	Analog Input Common Mode Rejection Ratio				80		dB

## DYNAMIC ACCURACY

The ● denotes the specifications which apply over the full operating temperature range, otherwise specifications are at  $T_A = 25^\circ\text{C}$ .  $A_{IN} = -1\text{dBFS}$ . (Note 4)

SYMBOL	PARAMETER	CONDITIONS	LTC2222			LTC2223			UNITS
			MIN	TYP	MAX	MIN	TYP	MAX	
SNR	Signal-to-Noise Ratio	30MHz Input (1V Range)		63.5		63.6		dB	
		30MHz Input (2V Range)	●	67	68.4	67.5	68.5	dB	
		70MHz Input (1V Range)		63.4		63.5		dB	
		70MHz Input (2V Range)		68.3		68.4		dB	
		140MHz Input (1V Range)		63.2		63.5		dB	
		140MHz Input (2V Range)		67.9		68.0		dB	
SFDR	Spurious Free Dynamic Range	30MHz Input (1V Range)		84		84		dB	
		30MHz Input (2V Range)	●	72	84	73	84	dB	
		70MHz Input (1V Range)		84		84		dB	
		70MHz Input (2V Range)		84		84		dB	
		140MHz Input (1V Range)		81		84		dB	
		140MHz Input (2V Range)		81		81		dB	
SFDR	Spurious Free Dynamic Range 4th Harmonic or Higher	30MHz Input (1V Range)		90		90		dB	
		30MHz Input (2V Range)		90		90		dB	
		70MHz Input (1V Range)		90		90		dB	
		70MHz Input (2V Range)		90		90		dB	
		140MHz Input (1V Range)		90		90		dB	
		140MHz Input (2V Range)		90		90		dB	
S/(N+D)	Signal-to-Noise Plus Distortion Ratio	30MHz Input (1V Range)		63.5		63.6		dB	
		30MHz Input (2V Range)	●	66.5	68.4	67	68.5	dB	
		70MHz Input (1V Range)		63.5		63.6		dB	
		70MHz Input (2V Range)		68.2		68.3		dB	
IMD	Intermodulation Distortion	$f_{IN1} = 138\text{MHz}, f_{IN2} = 140\text{MHz}$		81		81		dBc	

**INTERNAL REFERENCE CHARACTERISTICS** (Note 4)

PARAMETER	CONDITIONS	MIN	TYP	MAX	UNITS
$V_{CM}$ Output Voltage	$I_{OUT} = 0$	1.575	1.600	1.625	V
$V_{CM}$ Output Tempco			±25		ppm/°C
$V_{CM}$ Line Regulation	$3.1V < V_{DD} < 3.5V$		3		mV/V
$V_{CM}$ Output Resistance	$-1mA < I_{OUT} < 1mA$		4		Ω

**DIGITAL INPUTS AND DIGITAL OUTPUTS** The ● denotes the specifications which apply over the full operating temperature range, otherwise specifications are at  $T_A = 25^\circ\text{C}$ . (Note 4)

SYMBOL	PARAMETER	CONDITIONS	MIN	TYP	MAX	UNITS
<b>ENCODE INPUTS (ENC+, ENC-)</b>						
$V_{ID}$	Differential Input Voltage		●	0.2		V
$V_{ICM}$	Common Mode Input Voltage	Internally Set Externally Set (Note 7)	●	1.1	1.6 2.5	V V
$R_{IN}$	Input Resistance			6		kΩ
$C_{IN}$	Input Capacitance	(Note 7)		3		pF
<b>LOGIC INPUTS (<math>\overline{OE}</math>, SHDN)</b>						
$V_{IH}$	High Level Input Voltage	$V_{DD} = 3.3V$	●	2		V
$V_{IL}$	Low Level Input Voltage	$V_{DD} = 3.3V$	●		0.8	V
$I_{IN}$	Input Current	$V_{IN} = 0V$ to $V_{DD}$	●	-10	10	μA
$C_{IN}$	Input Capacitance	(Note 7)		3		pF
<b>LOGIC OUTPUTS</b>						
<b><math>OV_{DD} = 3.3V</math></b>						
$C_{OZ}$	Hi-Z Output Capacitance	$\overline{OE} = \text{High}$ (Note 7)		3		pF
$I_{SOURCE}$	Output Source Current	$V_{OUT} = 0V$		50		mA
$I_{SINK}$	Output Sink Current	$V_{OUT} = 3.3V$		50		mA
$V_{OH}$	High Level Output Voltage	$I_O = -10\mu A$ $I_O = -200\mu A$	●	3.1	3.295 3.29	V V
$V_{OL}$	Low Level Output Voltage	$I_O = 10\mu A$ $I_O = 1.6mA$	●		0.005 0.09	V V
<b><math>OV_{DD} = 2.5V</math></b>						
$V_{OH}$	High Level Output Voltage	$I_O = -200\mu A$		2.49		V
$V_{OL}$	Low Level Output Voltage	$I_O = 1.6mA$		0.09		V
<b><math>OV_{DD} = 1.8V</math></b>						
$V_{OH}$	High Level Output Voltage	$I_O = -200\mu A$		1.79		V
$V_{OL}$	Low Level Output Voltage	$I_O = 1.6mA$		0.09		V

**POWER REQUIREMENTS**

The ● denotes the specifications which apply over the full operating temperature range, otherwise specifications are at  $T_A = 25^\circ\text{C}$ . (Note 8)

SYMBOL	PARAMETER	CONDITIONS	LTC2222			LTC2223			UNITS
			MIN	TYP	MAX	MIN	TYP	MAX	
$V_{DD}$	Analog Supply Voltage	(Note 7)	● 3.1	3.3	3.5	3.1	3.3	3.5	V
$OV_{DD}$	Output Supply Voltage	(Note 7)	● 0.5	3.3	3.6	0.5	3.3	3.6	V
$I_{V_{DD}}$	Analog Supply Current		●	144	162	111	123		mA
$P_{DISS}$	Power Dissipation		●	475	535	366	406		mW
$P_{SHDN}$	Shutdown Power	SHDN = H, $\overline{OE}$ = H, No CLK		2		2			mW
$P_{NAP}$	Nap Mode Power	SHDN = H, $\overline{OE}$ = L, No CLK		35		35			mW

**TIMING CHARACTERISTICS**

The ● denotes the specifications which apply over the full operating temperature range, otherwise specifications are at  $T_A = 25^\circ\text{C}$ . (Note 4)

SYMBOL	PARAMETER	CONDITIONS	LTC2222			LTC2223			UNITS
			MIN	TYP	MAX	MIN	TYP	MAX	
$f_S$	Sampling Frequency		● 1		105	1		80	MHz
$t_L$	ENC Low Time	Duty Cycle Stabilizer Off	● 4.5	4.76	500	5.9	6.25	500	ns
		Duty Cycle Stabilizer On	● 3	4.76	500	3	6.25	500	ns
$t_H$	ENC High Time	Duty Cycle Stabilizer Off	● 4.5	4.76	500	5.9	6.25	500	ns
		Duty Cycle Stabilizer On	● 3	4.76	500	3	6.25	500	ns
$t_{AP}$	Sample-and-Hold Aperture Delay			0		0			ns
$t_D$	ENC to DATA Delay	(Note 7)	● 1.3	2.1	4	1.3	2.1	4	ns
$t_C$	ENC to CLOCKOUT Delay	(Note 7)	● 1.3	2.1	4	1.3	2.1	4	ns
	DATA to CLOCKOUT Skew	$(t_C - t_D)$ (Note 7)	● -0.6	0	0.6	-0.6	0	0.6	ns
$t_{OE}$	Output Enable Delay	(Note 7)	●	5	10	5	10		ns
	Pipeline Latency			5		5			Cycles

**Note 1:** Stresses beyond those listed under Absolute Maximum Ratings may cause permanent damage to the device. Exposure to any Absolute Maximum Rating condition for extended periods may affect device reliability and lifetime.

**Note 2:** All voltage values are with respect to ground with GND and OGNB wired together (unless otherwise noted).

**Note 3:** When these pin voltages are taken below GND or above  $V_{DD}$ , they will be clamped by internal diodes. This product can handle input currents of greater than 100mA below GND or above  $V_{DD}$  without latchup.

**Note 4:**  $V_{DD} = 3.3\text{V}$ ,  $f_{SAMPLE} = 105\text{MHz}$  (LTC2222) or 80MHz (LTC2223), differential  $ENC^+/ENC^- = 2V_{P-P}$  sine wave, input range =  $2V_{P-P}$  with differential drive, unless otherwise noted.

**Note 5:** Integral nonlinearity is defined as the deviation of a code from a straight line passing through the actual endpoints of the transfer curve. The deviation is measured from the center of the quantization band.

**Note 6:** Offset error is the offset voltage measured from  $-0.5$  LSB when the output code flickers between 0000 0000 0000 and 1111 1111 1111 in 2's complement output mode.

**Note 7:** Guaranteed by design, not subject to test.

**Note 8:**  $V_{DD} = 3.3\text{V}$ ,  $f_{SAMPLE} = 105\text{MHz}$  (LTC2222) or 80MHz (LTC2223), differential  $ENC^+/ENC^- = 2V_{P-P}$  sine wave, input range =  $1V_{P-P}$  with differential drive.

## TYPICAL PERFORMANCE CHARACTERISTICS

www.datasheet4u.com

**LTC2222: INL, 2V Range**

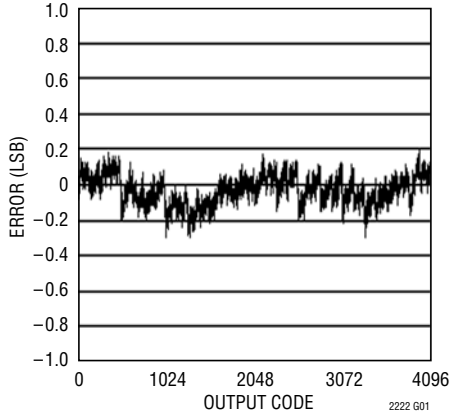

**LTC2222: DNL, 2V Range**

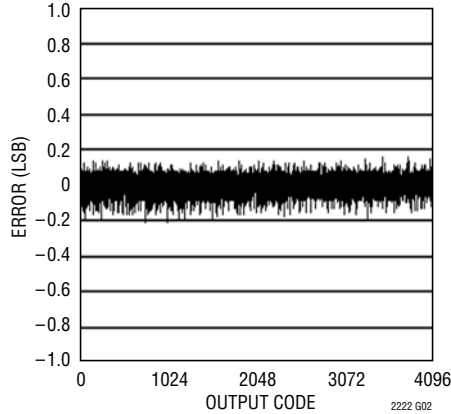

**LTC2222: SNR vs Input Frequency, -1dB, 2V Range**

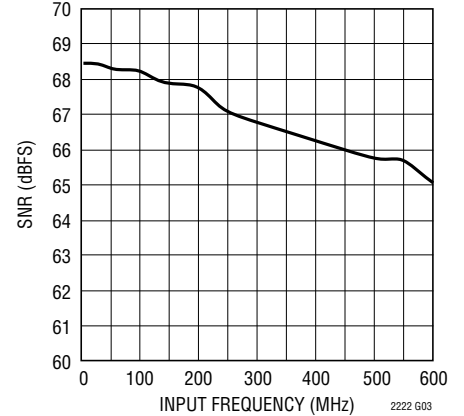

**LTC2222: SNR vs Input Frequency, -1dB, 1V Range**

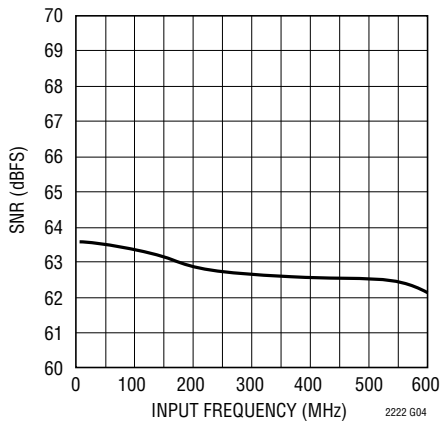

**LTC2222: SFDR (HD2 and HD3) vs Input Frequency, -1dB, 2V Range**

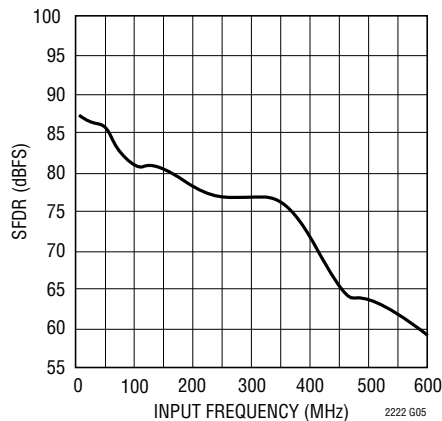

**LTC2222: SFDR (HD2 and HD3) vs Input Frequency, -1dB, 1V Range**

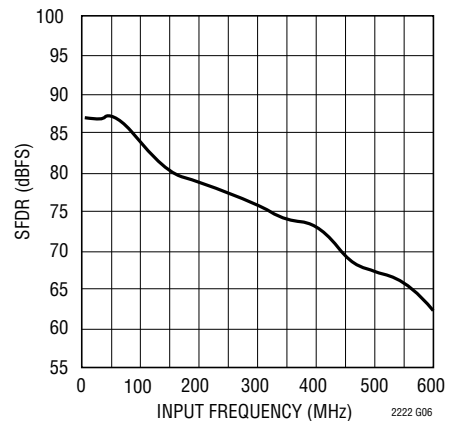

**LTC2222: SFDR (HD4+) vs Input Frequency, -1dB, 2V Range**

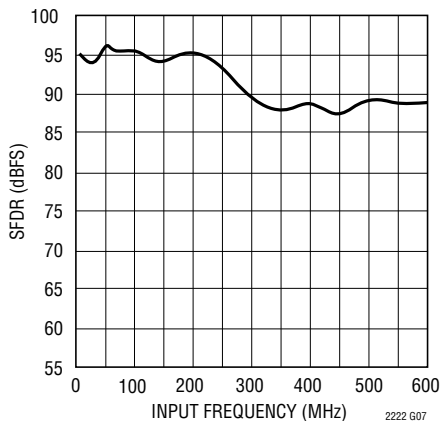

**LTC2222: SFDR (HD4+) vs Input Frequency, -1dB, 1V Range**

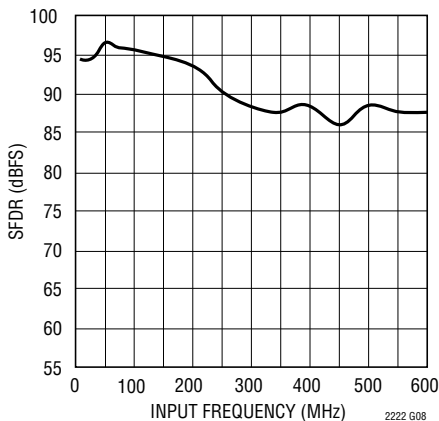

**LTC2222: SFDR and SNR vs Sample Rate, 2V Range,  $f_{IN} = 30\text{MHz}$ , -1dB**

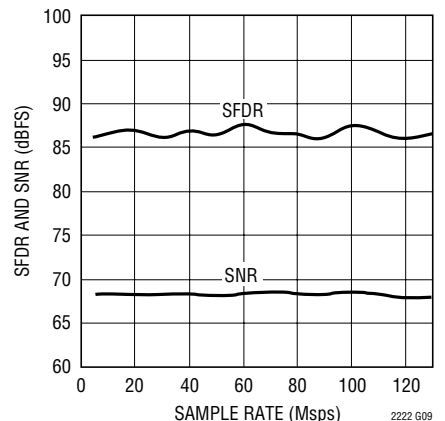

22223fa

# TYPICAL PERFORMANCE CHARACTERISTICS

LTC2222: SFDR and SNR vs Sample Rate, 1V Range,  $f_{IN} = 30\text{MHz}$ ,  $-1\text{dB}$

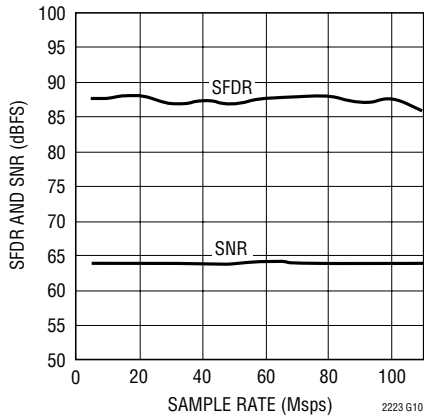

LTC2222:  $I_{VDD}$  vs Sample Rate, 5MHz Sine Wave Input,  $-1\text{dB}$

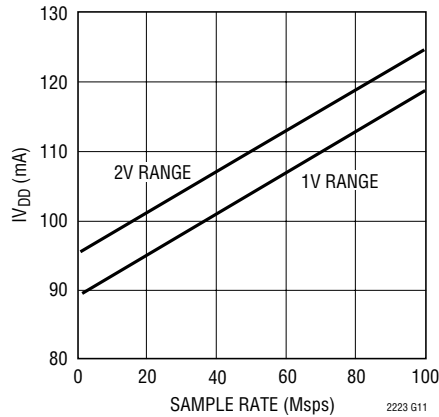

LTC2222:  $I_{OVD}$  vs Sample Rate, 5MHz Sine Wave Input,  $-1\text{dB}$ ,  $0V_{DD} = 1.8\text{V}$

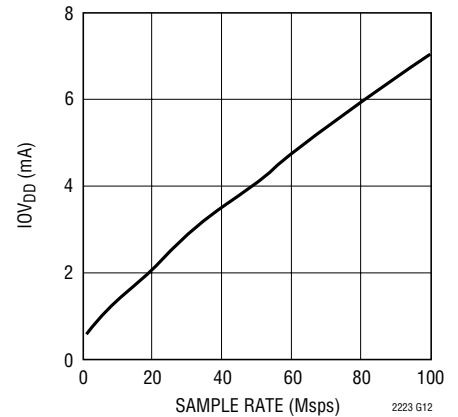

LTC2222: SFDR vs Input Level,  $f_{IN} = 70\text{MHz}$ , 2V Range

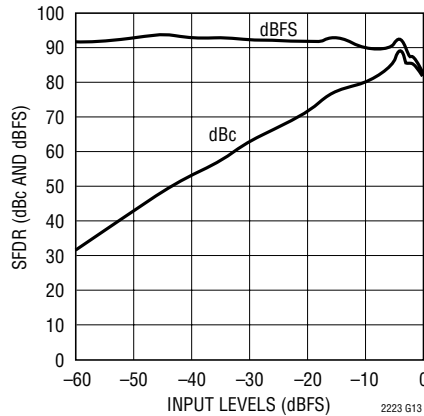

LTC2222: 8192 Point FFT,  $f_{IN} = 5\text{MHz}$ ,  $-1\text{dB}$ , 2V Range

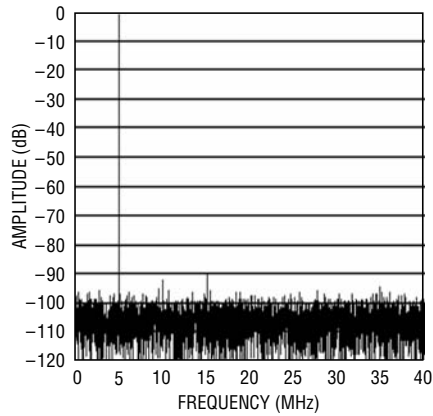

LTC2222: 8192 Point FFT,  $f_{IN} = 5\text{MHz}$ ,  $-1\text{dB}$ , 1V Range

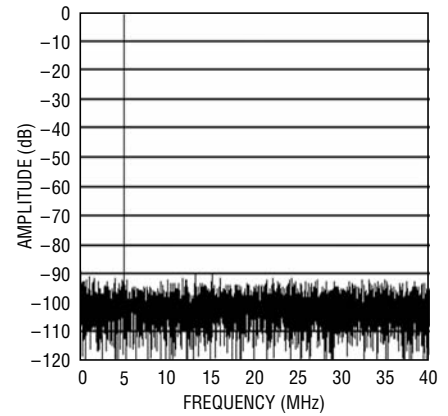

LTC2222: 8192 Point FFT,  $f_{IN} = 30\text{MHz}$ ,  $-1\text{dB}$ , 2V Range

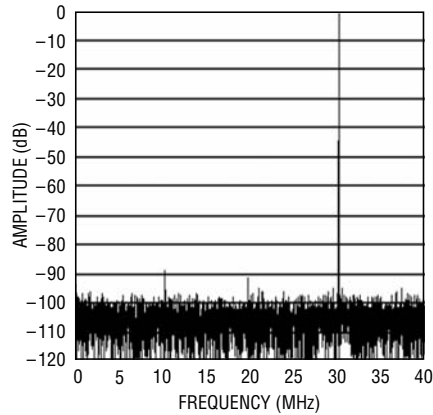

LTC2222: 8192 Point FFT,  $f_{IN} = 30\text{MHz}$ ,  $-1\text{dB}$ , 1V Range

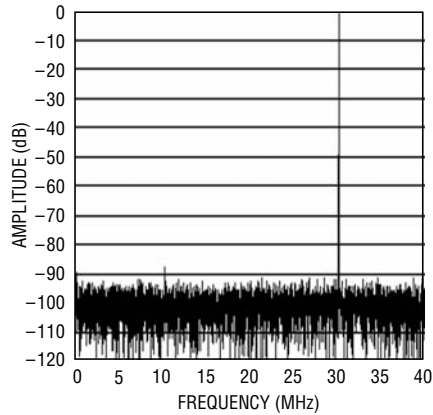

LTC2222: 8192 Point FFT,  $f_{IN} = 70\text{MHz}$ ,  $-1\text{dB}$ , 2V Range

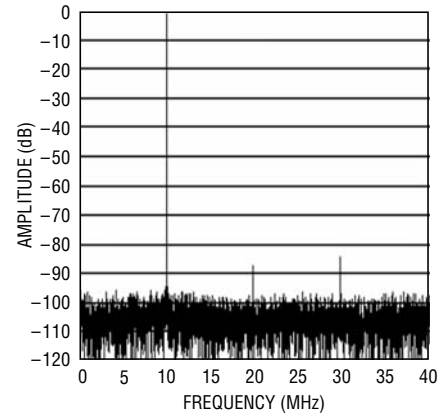

## TYPICAL PERFORMANCE CHARACTERISTICS

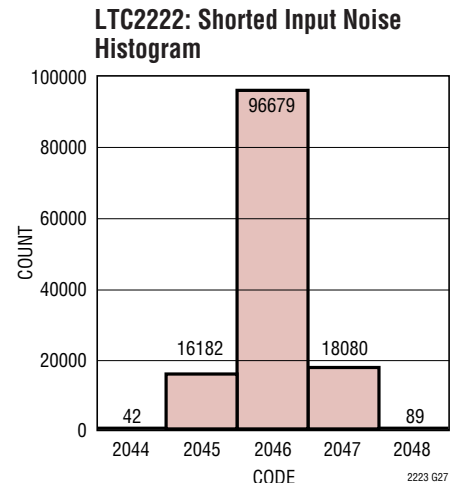
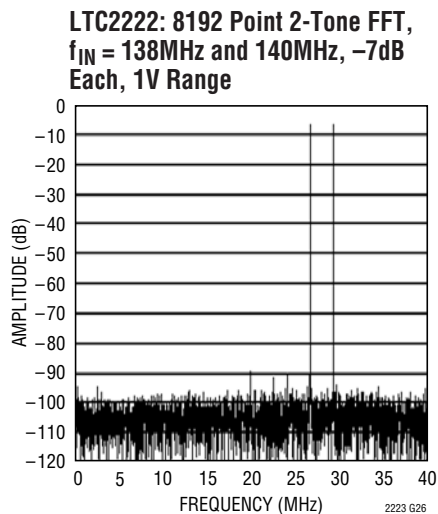
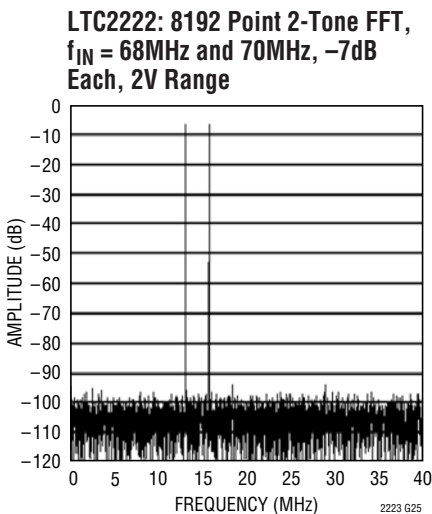
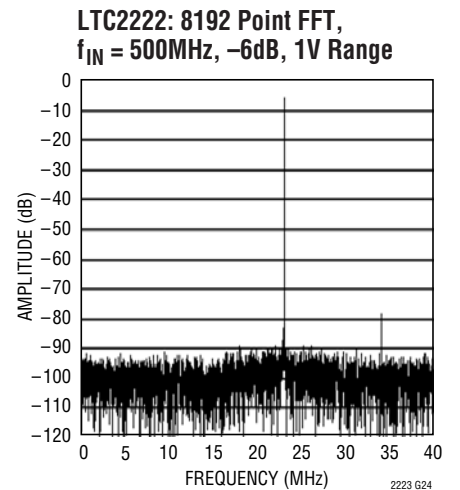
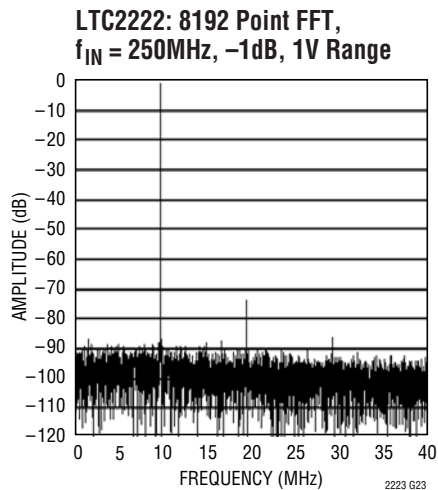
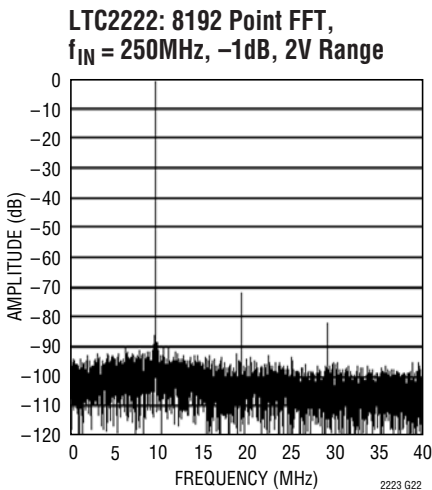
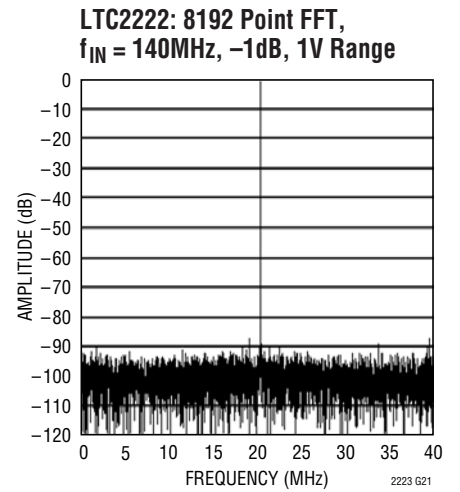
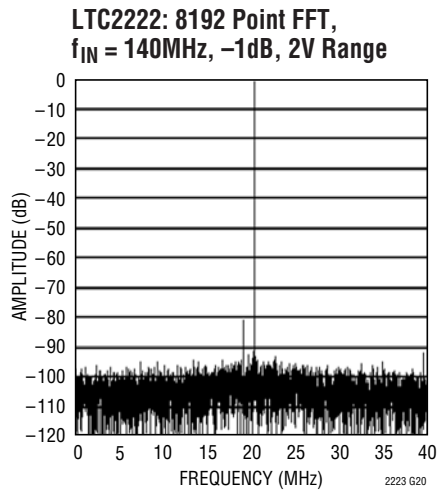
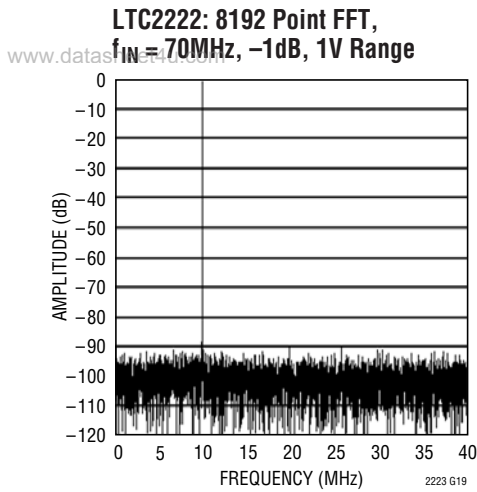



# TYPICAL PERFORMANCE CHARACTERISTICS

LTC2223: INL, 2V Range

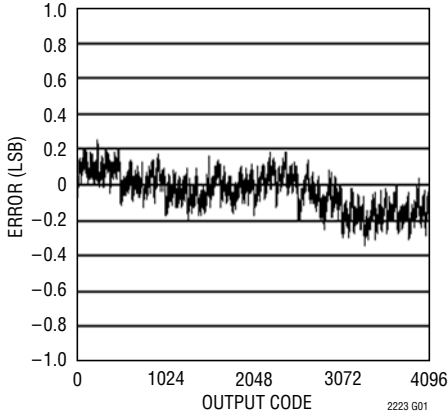

LTC2223: DNL, 2V Range

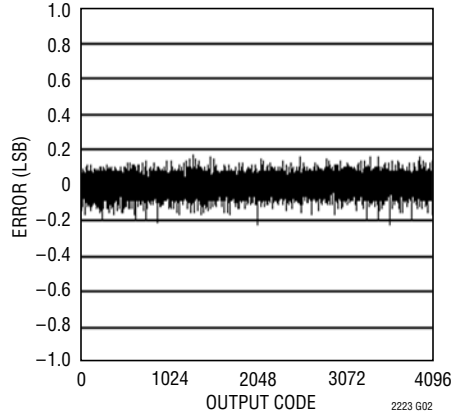

LTC2223: SNR vs Input Frequency, -1dB, 2V Range

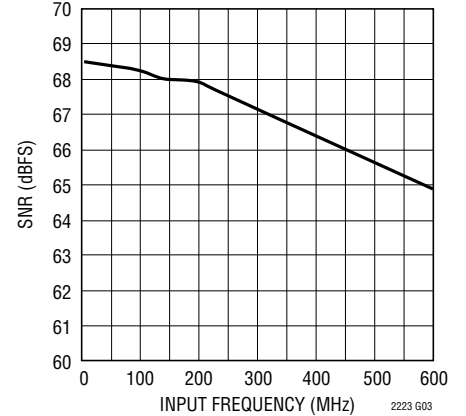

LTC2223: SNR vs Input Frequency, -1dB, 1V Range

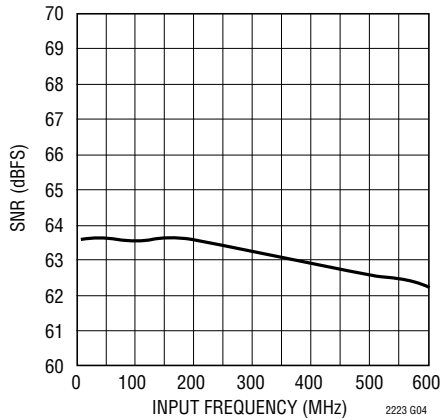

LTC2223: SFDR (HD2 and HD3) vs Input Frequency, -1dB, 2V Range

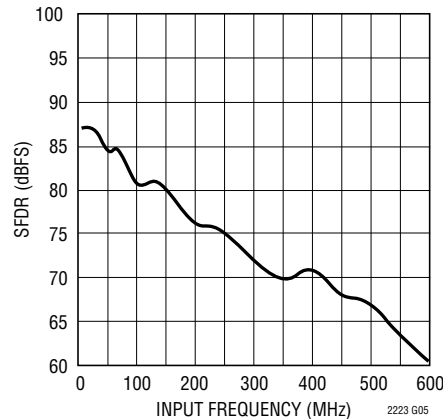

LTC2223: SFDR (HD2 and HD3) vs Input Frequency, -1dB, 1V Range

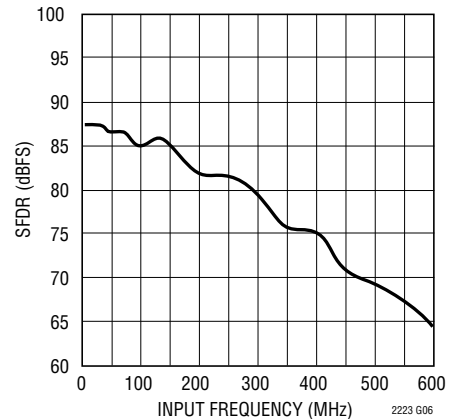

LTC2223: SFDR (HD4+) vs Input Frequency, -1dB, 2V Range

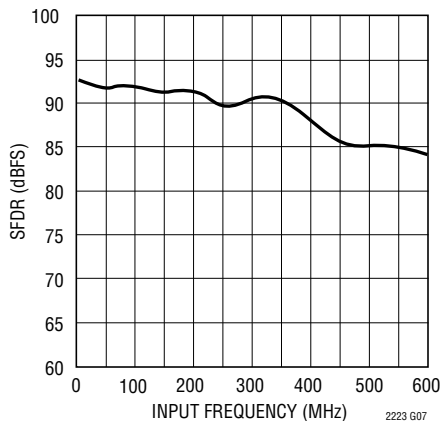

LTC2223: SFDR (HD4+) vs Input Frequency, -1dB, 1V Range

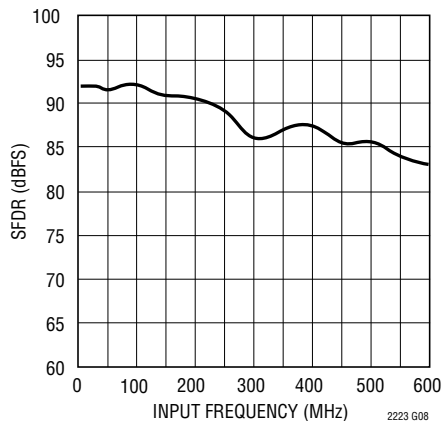

LTC2223: SFDR and SNR vs Sample Rate, 2V Range,  $f_{IN} = 30\text{MHz}$ , -1dB

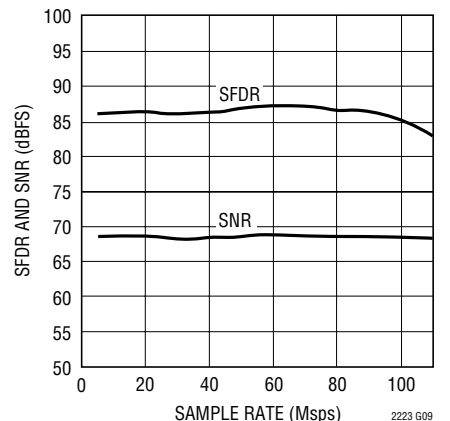

22223fa

## TYPICAL PERFORMANCE CHARACTERISTICS

**LTC2223: SFDR and SNR vs Sample Rate, 1V Range,  $f_{IN} = 30\text{MHz}$ ,  $-1\text{dB}$**

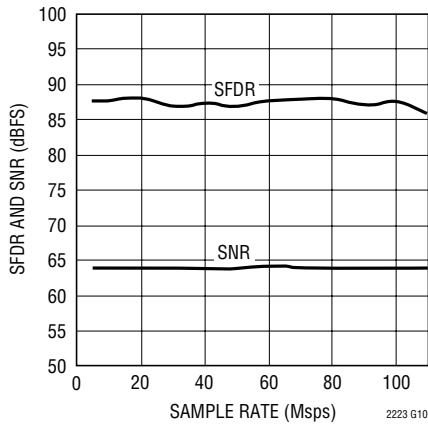

**LTC2223:  $I_{VDD}$  vs Sample Rate, 5MHz Sine Wave Input,  $-1\text{dB}$**

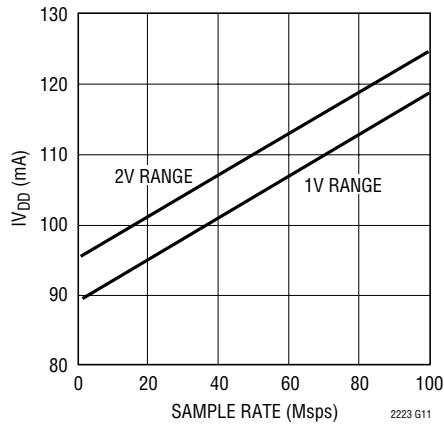

**LTC2223:  $I_{OVD}$  vs Sample Rate, 5MHz Sine Wave Input,  $-1\text{dB}$ ,  $O_{VDD} = 1.8\text{V}$**

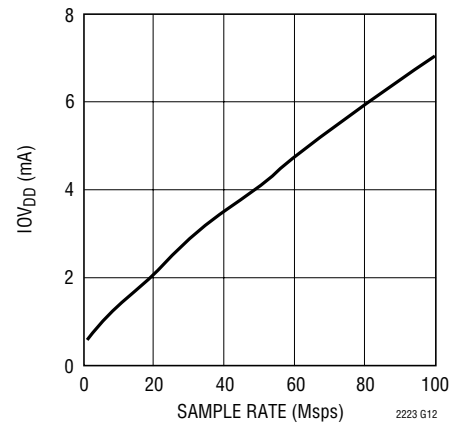

**LTC2223: SFDR vs Input Level,  $f_{IN} = 70\text{MHz}$ , 2V Range**

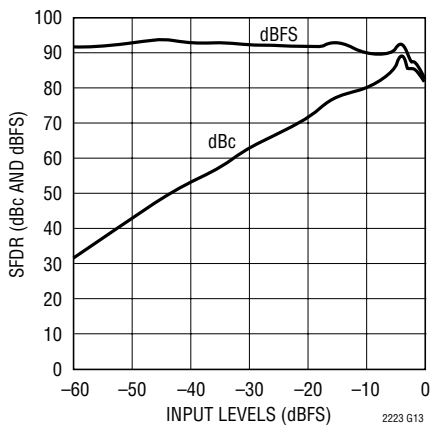

**LTC2223: 8192 Point FFT,  $f_{IN} = 5\text{MHz}$ ,  $-1\text{dB}$ , 2V Range**

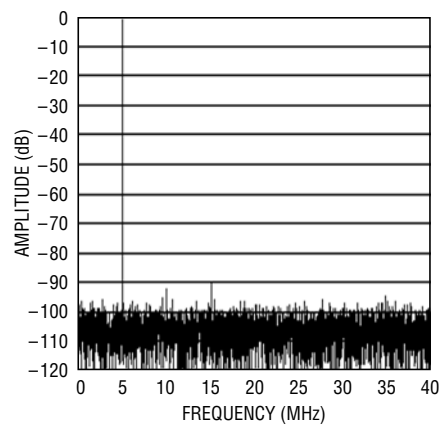

**LTC2223: 8192 Point FFT,  $f_{IN} = 5\text{MHz}$ ,  $-1\text{dB}$ , 1V Range**

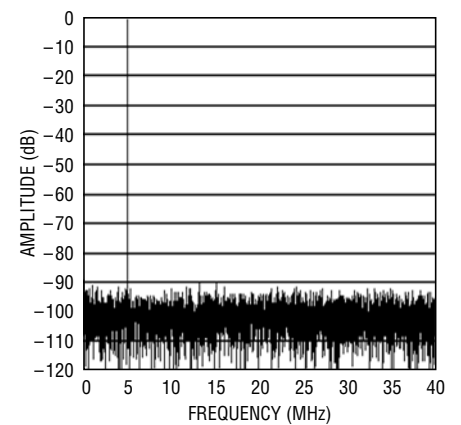

**LTC2223: 8192 Point FFT,  $f_{IN} = 30\text{MHz}$ ,  $-1\text{dB}$ , 2V Range**

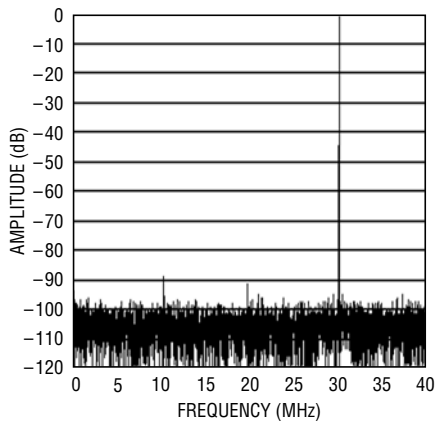

**LTC2223: 8192 Point FFT,  $f_{IN} = 30\text{MHz}$ ,  $-1\text{dB}$ , 1V Range**

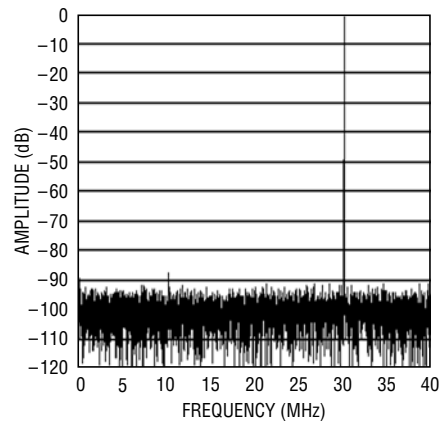

**LTC2223: 8192 Point FFT,  $f_{IN} = 70\text{MHz}$ ,  $-1\text{dB}$ , 2V Range**

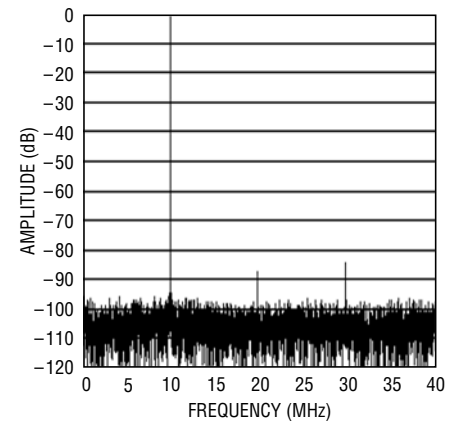

# TYPICAL PERFORMANCE CHARACTERISTICS

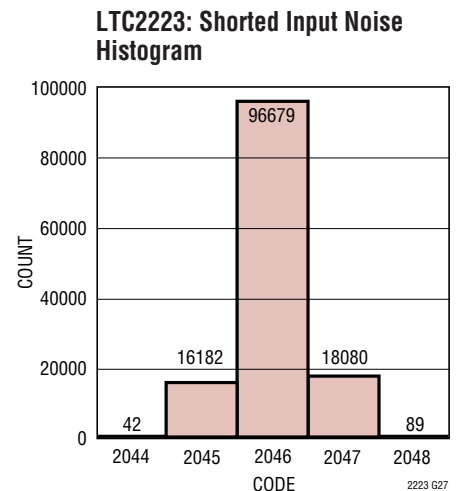
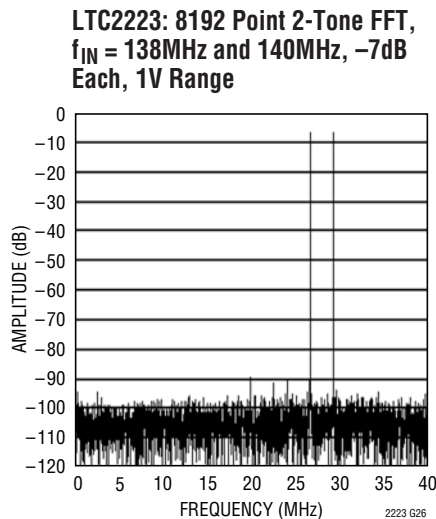
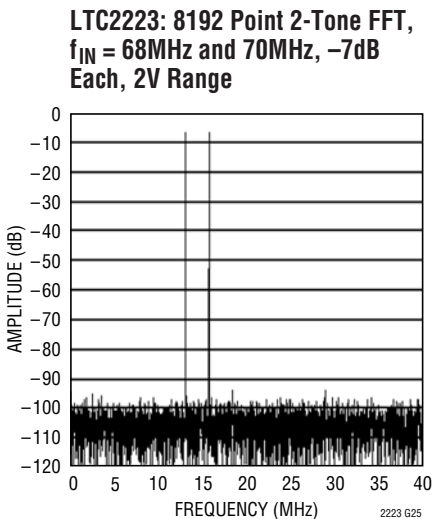
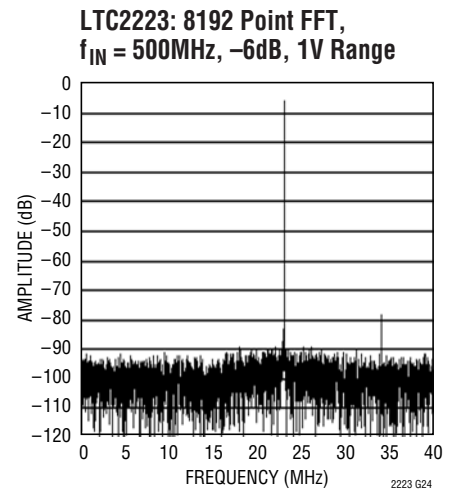
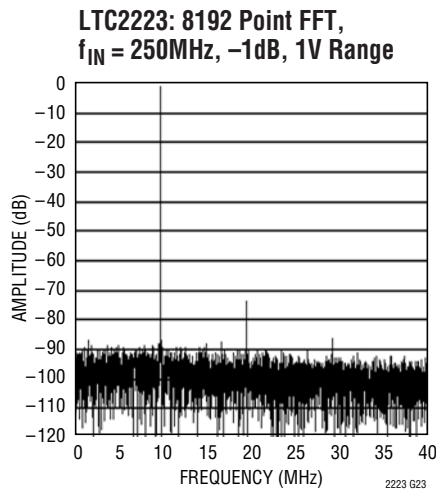
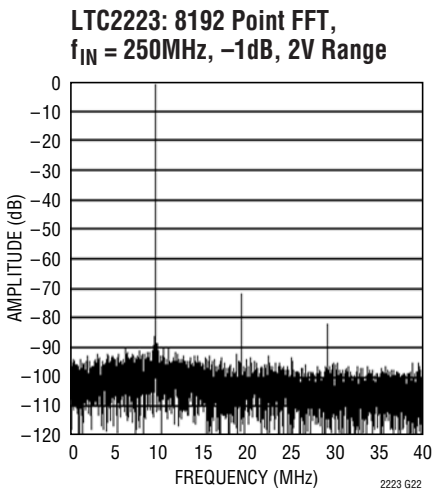
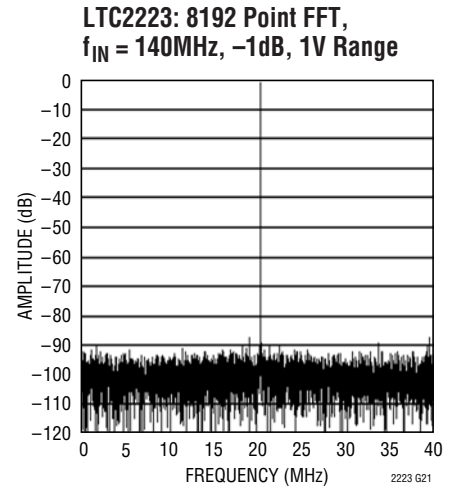
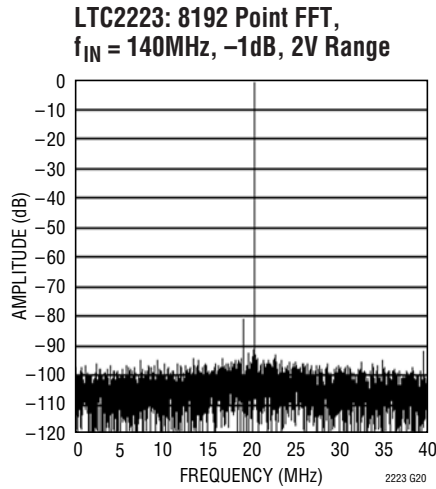
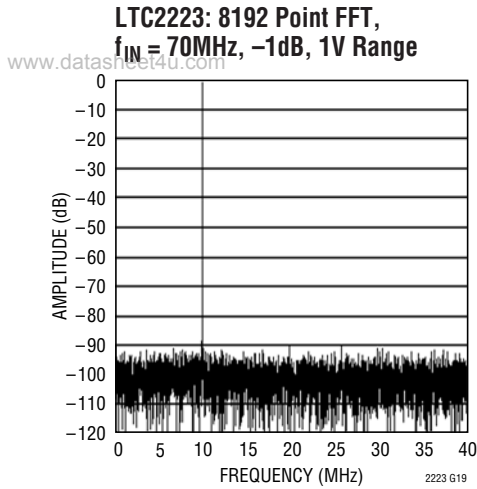

## PIN FUNCTIONS

**A<sub>IN+</sub> (Pin 1):** Positive Differential Analog Input.

**A<sub>IN-</sub> (Pin 2):** Negative Differential Analog Input.

www.datasheet4u.com

**REFHA (Pins 3, 4):** ADC High Reference. Bypass to Pins 5, 6 with 0.1 $\mu$ F ceramic chip capacitor, to Pins 9, 10 with a 2.2 $\mu$ F ceramic capacitor and to ground with a 1 $\mu$ F ceramic capacitor.

**REFLB (Pins 5, 6):** ADC Low Reference. Bypass to Pins 3, 4 with 0.1 $\mu$ F ceramic chip capacitor. Do not connect to Pins 9, 10.

**REFHB (Pins 7, 8):** ADC High Reference. Bypass to Pins 9, 10 with 0.1 $\mu$ F ceramic chip capacitor. Do not connect to Pins 3, 4.

**REFLA (Pins 9, 10):** ADC Low Reference. Bypass to Pins 7, 8 with 0.1 $\mu$ F ceramic chip capacitor, to Pins 3, 4 with a 2.2 $\mu$ F ceramic capacitor and to ground with a 1 $\mu$ F ceramic capacitor.

**V<sub>DD</sub> (Pins 11, 12, 14, 46, 47):** 3.3V Supply. Bypass to GND with 0.1 $\mu$ F ceramic chip capacitors. Adjacent pins can share a bypass capacitor.

**GND (Pins 13, 15, 45, 48):** ADC Power Ground.

**ENC<sup>+</sup> (Pin 16):** Encode Input. The input is sampled on the positive edge.

**ENC<sup>-</sup> (Pin 17):** Encode Complement Input. The input is sampled on the negative edge. Bypass to ground with 0.1 $\mu$ F ceramic for single-ended ENCODE signal.

**SHDN (Pin 18):** Shutdown Mode Selection Pin. Connecting SHDN to GND and  $\overline{OE}$  to GND results in normal operation with the outputs enabled. Connecting SHDN to GND and  $\overline{OE}$  to V<sub>DD</sub> results in normal operation with the outputs at high impedance. Connecting SHDN to V<sub>DD</sub> and  $\overline{OE}$  to GND results in nap mode with the outputs at high impedance. Connecting SHDN to V<sub>DD</sub> and  $\overline{OE}$  to V<sub>DD</sub> results in sleep mode with the outputs at high impedance.

**$\overline{OE}$  (Pin 19):** Output Enable Pin. Refer to SHDN pin function.

**CLOCKOUT (Pin 20):** Data Valid Output. Latch data on the falling edge of CLKOUT.

**D0 – D11 (Pins 21, 24, 25, 26, 29, 30, 31, 34, 35, 36, 39, 40):** Digital Outputs. D11 is the MSB.

**OGND (Pins 22, 27, 32, 38):** Output Driver Ground.

**OV<sub>DD</sub> (Pins 23, 28, 33, 37):** Positive Supply for the Output Drivers. Bypass to ground with 0.1 $\mu$ F ceramic chip capacitors.

**OF (Pin 41):** Over/Under Flow Output. High when an over or under flow has occurred.

**MODE (Pin 42):** Output Format and Clock Duty Cycle Stabilizer Selection Pin. Connecting MODE to 0V selects offset binary output format and turns the clock duty cycle stabilizer off. Connecting MODE to 1/3 V<sub>DD</sub> selects offset binary output format and turns the clock duty cycle stabilizer on. Connecting MODE to 2/3 V<sub>DD</sub> selects 2's complement output format and turns the clock duty cycle stabilizer on. Connecting MODE to V<sub>DD</sub> selects 2's complement output format and turns the clock duty cycle stabilizer off.

**SENSE (Pin 43):** Reference Programming Pin. Connecting SENSE to V<sub>CM</sub> selects the internal reference and a  $\pm 0.5V$  input range. V<sub>DD</sub> selects the internal reference and a  $\pm 1V$  input range. An external reference greater than 0.5V and less than 1V applied to SENSE selects an input range of  $\pm V_{SENSE}$ .  $\pm 1V$  is the largest valid input range.

**V<sub>CM</sub> (Pin 44):** 1.6V Output and Input Common Mode Bias. Bypass to ground with 2.2 $\mu$ F ceramic chip capacitor.

**GND (Exposed Pad):** ADC Power Ground. The exposed pad on the bottom of the package needs to be soldered to ground.

# FUNCTIONAL BLOCK DIAGRAM

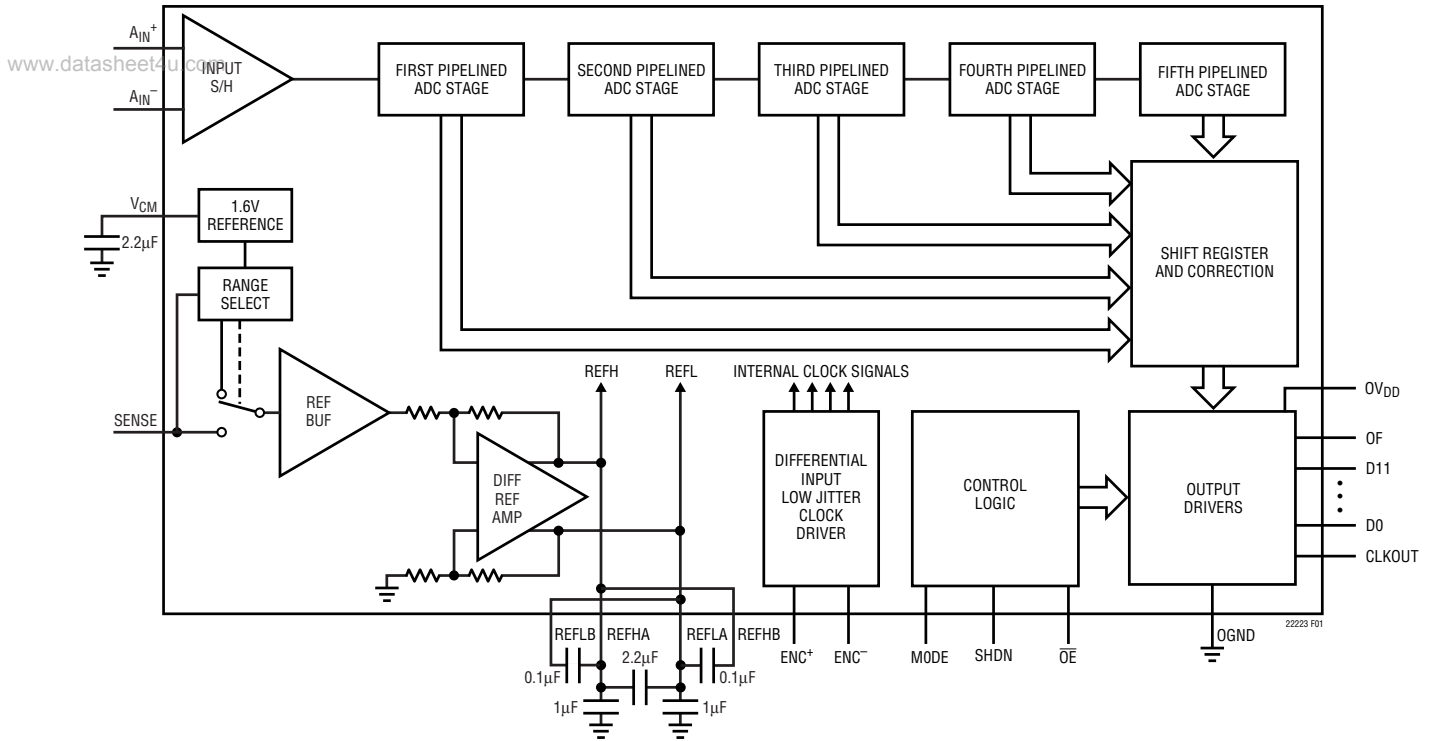
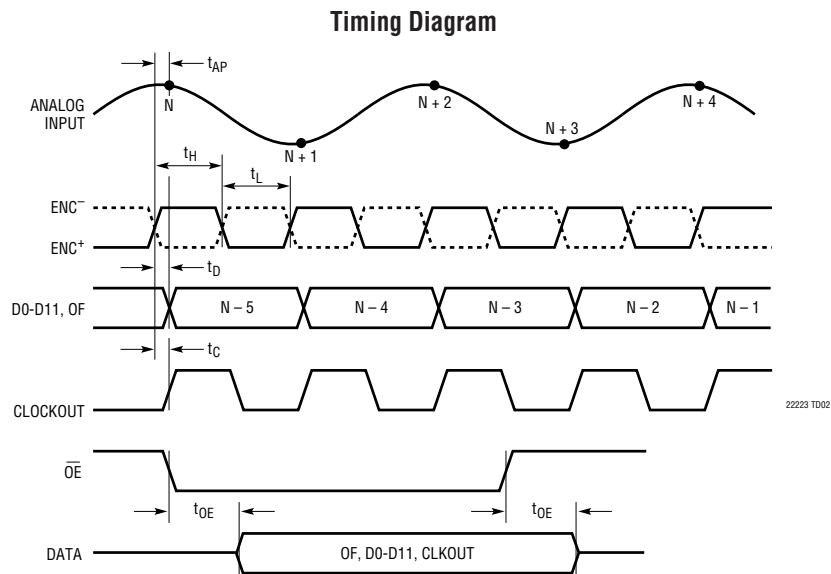

Figure 1. Functional Block Diagram

# TIMING DIAGRAMS



## APPLICATIONS INFORMATION

### DYNAMIC PERFORMANCE

#### Signal-to-Noise Plus Distortion Ratio

The signal-to-noise plus distortion ratio  $[S/(N + D)]$  is the ratio between the RMS amplitude of the fundamental input frequency and the RMS amplitude of all other frequency components at the ADC output. The output is band limited to frequencies above DC to below half the sampling frequency.

#### Signal-to-Noise Ratio

The signal-to-noise ratio (SNR) is the ratio between the RMS amplitude of the fundamental input frequency and the RMS amplitude of all other frequency components except the first five harmonics and DC.

#### Total Harmonic Distortion

Total harmonic distortion is the ratio of the RMS sum of all harmonics of the input signal to the fundamental itself. The out-of-band harmonics alias into the frequency band between DC and half the sampling frequency. THD is expressed as:

$$\text{THD} = 20\text{Log} (\sqrt{V_2^2 + V_3^2 + V_4^2 + \dots + V_n^2})/V_1$$

where  $V_1$  is the RMS amplitude of the fundamental frequency and  $V_2$  through  $V_n$  are the amplitudes of the second through  $n$ th harmonics. The THD calculated in this data sheet uses all the harmonics up to the fifth.

#### Intermodulation Distortion

If the ADC input signal consists of more than one spectral component, the ADC transfer function nonlinearity can produce intermodulation distortion (IMD) in addition to THD. IMD is the change in one sinusoidal input caused by the presence of another sinusoidal input at a different frequency.

If two pure sine waves of frequencies  $f_a$  and  $f_b$  are applied to the ADC input, nonlinearities in the ADC transfer function can create distortion products at the sum and difference frequencies of  $m f_a \pm n f_b$ , where  $m$  and  $n = 0, 1, 2, 3$ , etc. The 3rd order intermodulation products are  $2f_a + f_b$ ,  $2f_b + f_a$ ,  $2f_a - f_b$  and  $2f_b - f_a$ . The intermodulation distortion is defined as the ratio of the RMS value of either input tone to the RMS value of the largest 3rd order intermodulation product.

#### Spurious Free Dynamic Range (SFDR)

Spurious free dynamic range is the peak harmonic or spurious noise that is the largest spectral component excluding the input signal and DC. This value is expressed in decibels relative to the RMS value of a full scale input signal.

#### Input Bandwidth

The input bandwidth is that input frequency at which the amplitude of the reconstructed fundamental is reduced by 3dB for a full scale input signal.

#### Aperture Delay Time

The time from when a rising  $\text{ENC}^+$  equals the  $\text{ENC}^-$  voltage to the instant that the input signal is held by the sample and hold circuit.

#### Aperture Delay Jitter

The variation in the aperture delay time from conversion to conversion. This random variation will result in noise when sampling an AC input. The signal to noise ratio due to the jitter alone will be:

$$\text{SNR}_{\text{JITTER}} = -20\text{log} (2\pi \cdot f_{\text{IN}} \cdot t_{\text{JITTER}})$$

## APPLICATIONS INFORMATION

### CONVERTER OPERATION

As shown in Figure 1, the LTC2222/LTC2223 is a CMOS pipelined multistep converter. The converter has five pipelined ADC stages; a sampled analog input will result in a digitized value five cycles later (see the Timing Diagram section). For optimal AC performance the analog inputs should be driven differentially. For cost sensitive applications, the analog inputs can be driven single-ended with slightly worse harmonic distortion. The encode input is differential for improved common mode noise immunity. The LTC2222/LTC2223 has two phases of operation, determined by the state of the differential ENC<sup>+</sup>/ENC<sup>-</sup> input pins. For brevity, the text will refer to ENC<sup>+</sup> greater than ENC<sup>-</sup> as ENC high and ENC<sup>+</sup> less than ENC<sup>-</sup> as ENC low.

Each pipelined stage shown in Figure 1 contains an ADC, a reconstruction DAC and an interstage residue amplifier. In operation, the ADC quantizes the input to the stage and the quantized value is subtracted from the input by the DAC to produce a residue. The residue is amplified and output by the residue amplifier. Successive stages operate out of phase so that when the odd stages are outputting their residue, the even stages are acquiring that residue and vice versa.

When ENC is low, the analog input is sampled differentially directly onto the input sample-and-hold capacitors, inside the "Input S/H" shown in the block diagram. At the instant that ENC transitions from low to high, the sampled input is held. While ENC is high, the held input voltage is buffered by the S/H amplifier which drives the first pipelined ADC stage. The first stage acquires the output of the S/H during this high phase of ENC. When ENC goes back low, the first stage produces its residue which is acquired by the second stage. At the same time, the input S/H goes back to acquiring the analog input. When ENC goes back high, the second stage produces its residue which is acquired by the third stage. An identical process is repeated for the third and fourth stages, resulting in a fourth stage residue that is sent to the fifth stage ADC for final evaluation.

Each ADC stage following the first has additional range to accommodate flash and amplifier offset errors. Results from all of the ADC stages are digitally synchronized such that the results can be properly combined in the correction logic before being sent to the output buffer.

### SAMPLE/HOLD OPERATION AND INPUT DRIVE

#### Sample/Hold Operation

Figure 2 shows an equivalent circuit for the LTC2222/LTC2223 CMOS differential sample-and-hold. The analog inputs are connected to the sampling capacitors ( $C_{SAMPLE}$ ) through NMOS transistors. The capacitors shown attached to each input ( $C_{PARASITIC}$ ) are the summation of all other capacitance associated with each input.

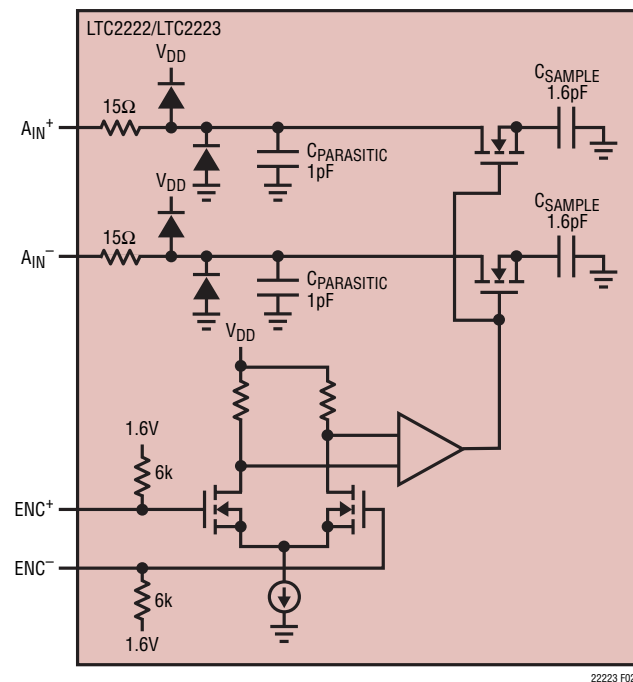

Figure 2. Equivalent Input Circuit

22223 F02



## APPLICATIONS INFORMATION

During the sample phase when ENC is low, the transistors connect the analog inputs to the sampling capacitors and they charge to, and track the differential input voltage. When ENC transitions from low to high, the sampled input voltage is held on the sampling capacitors. During the hold phase when ENC is high, the sampling capacitors are disconnected from the input and the held voltage is passed to the ADC core for processing. As ENC transitions from high to low, the inputs are reconnected to the sampling capacitors to acquire a new sample. Since the sampling capacitors still hold the previous sample, a charging glitch proportional to the change in voltage between samples will be seen at this time. If the change between the last sample and the new sample is small, the charging glitch seen at the input will be small. If the input change is large, such as the change seen with input frequencies near Nyquist, then a larger charging glitch will be seen.

### Single-Ended Input

For cost sensitive applications, the analog inputs can be driven single-ended. With a single-ended input the harmonic distortion and INL will degrade, but the SNR and DNL will remain unchanged. For a single-ended input,  $A_{IN}^+$  should be driven with the input signal and  $A_{IN}^-$  should be connected to 1.6V or  $V_{CM}$ .

### Common Mode Bias

For optimal performance the analog inputs should be driven differentially. Each input should swing  $\pm 0.5V$  for the 2V range or  $\pm 0.25V$  for the 1V range, around a common mode voltage of 1.6V. The  $V_{CM}$  output pin (Pin 44) may be used to provide the common mode bias level.  $V_{CM}$  can be tied directly to the center tap of a transformer to set the DC input level or as a reference level to an op amp differential driver circuit. The  $V_{CM}$  pin must be bypassed to ground close to the ADC with a 2.2 $\mu F$  or greater capacitor.

### Input Drive Impedance

As with all high performance, high speed ADCs, the dynamic performance of the LTC2222/LTC2223 can be influenced by the input drive circuitry, particularly the second and third harmonics. Source impedance and input reactance can influence SFDR. At the falling edge of ENC,

the sample-and-hold circuit will connect the 1.6pF sampling capacitor to the input pin and start the sampling period. The sampling period ends when ENC rises, holding the sampled input on the sampling capacitor. Ideally the input circuitry should be fast enough to fully charge the sampling capacitor during the sampling period  $1/(2F_{ENCODE})$ ; however, this is not always possible and the incomplete settling may degrade the SFDR. The sampling glitch has been designed to be as linear as possible to minimize the effects of incomplete settling.

For the best performance, it is recommended to have a source impedance of 100 $\Omega$  or less for each input. The source impedance should be matched for the differential inputs. Poor matching will result in higher even order harmonics, especially the second.

### Input Drive Circuits

Figure 3 shows the LTC2222/LTC2223 being driven by an RF transformer with a center tapped secondary. The secondary center tap is DC biased with  $V_{CM}$ , setting the ADC input signal at its optimum DC level. Terminating on the transformer secondary is desirable, as this provides a common mode path for charging glitches caused by the sample and hold. Figure 3 shows a 1:1 turns ratio transformer. Other turns ratios can be used if the source impedance seen by the ADC does not exceed 100 $\Omega$  for each ADC input. A disadvantage of using a transformer is the loss of low frequency response. Most small RF transformers have poor performance at frequencies below 1MHz.

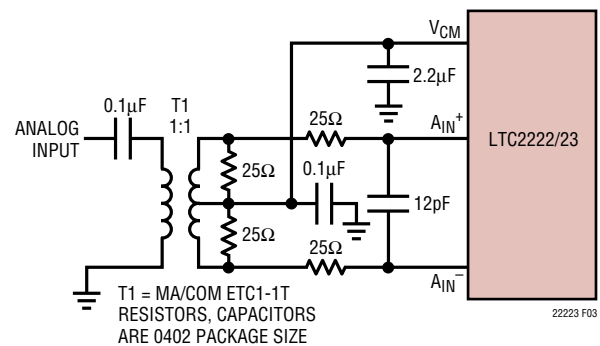

Figure 3. Single-Ended to Differential Conversion Using a Transformer



## APPLICATIONS INFORMATION

Figure 4 demonstrates the use of a differential amplifier to convert a single ended input signal into a differential input signal. The advantage of this method is that it provides low frequency input response; however, the limited gain bandwidth of most op amps will limit the SFDR at high input frequencies.

Figure 5 shows a single-ended input circuit. The impedance seen by the analog inputs should be matched. This circuit is not recommended if low distortion is required.

The 25Ω resistors and 12pF capacitor on the analog inputs serve two purposes: isolating the drive circuitry from the sample-and-hold charging glitches and limiting the wideband noise at the converter input. For input frequencies higher than 100MHz, the capacitor may need to be decreased to prevent excessive signal loss.

For input frequencies above 100MHz the input circuits of Figure 6, 7 and 8 are recommended. The balun transformer gives better high frequency response than a flux coupled center tapped transformer. The coupling capacitors allow the analog inputs to be DC biased at 1.6V. In Figure 8 the series inductors are impedance matching elements that maximize the ADC bandwidth.

### Reference Operation

Figure 9 shows the LTC2222/LTC2223 reference circuitry consisting of a 1.6V bandgap reference, a difference amplifier and switching and control circuit. The internal voltage reference can be configured for two pin selectable

input ranges of 2V ( $\pm 1V$  differential) or 1V ( $\pm 0.5V$  differential). Tying the SENSE pin to  $V_{DD}$  selects the 2V range; tying the SENSE pin to  $V_{CM}$  selects the 1V range.

The 1.6V bandgap reference serves two functions: its output provides a DC bias point for setting the common mode voltage of any external input circuitry; additionally, the reference is used with a difference amplifier to generate the differential reference levels needed by the internal ADC circuitry. An external bypass capacitor is required for the 1.6V reference output,  $V_{CM}$ . This provides a high frequency low impedance path to ground for internal and external circuitry.

The difference amplifier generates the high and low reference for the ADC. High speed switching circuits are connected to these outputs and they must be externally bypassed. Each output has four pins: two each of REFHA and REFHB for the high reference and two each of REFLA and REFLB for the low reference. The multiple output pins are needed to reduce package inductance. Bypass capacitors must be connected as shown in Figure 9.

Other voltage ranges in between the pin selectable ranges can be programmed with two external resistors as shown in Figure 10. An external reference can be used by applying its output directly or through a resistor divider to SENSE. It is not recommended to drive the SENSE pin with a logic device. The SENSE pin should be tied to the appropriate level as close to the converter as possible. If the SENSE pin is driven externally, it should be bypassed to ground as close to the device as possible with a 1μF ceramic capacitor.



# APPLICATIONS INFORMATION

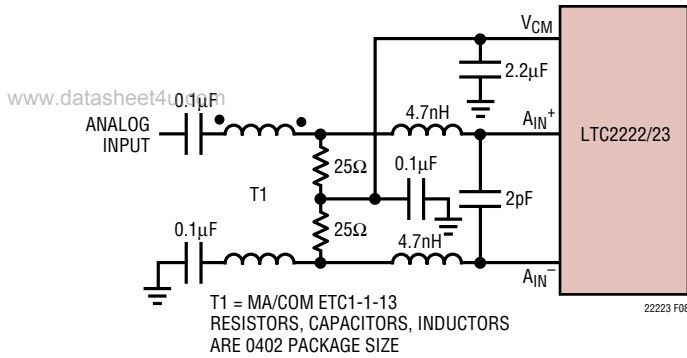

Figure 8. Recommended Front End Circuit for Input Frequencies Above 500MHz

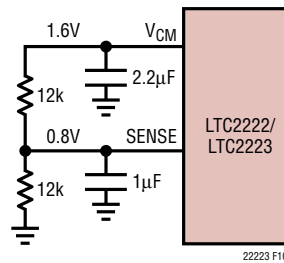

Figure 10. 1.6V Range ADC

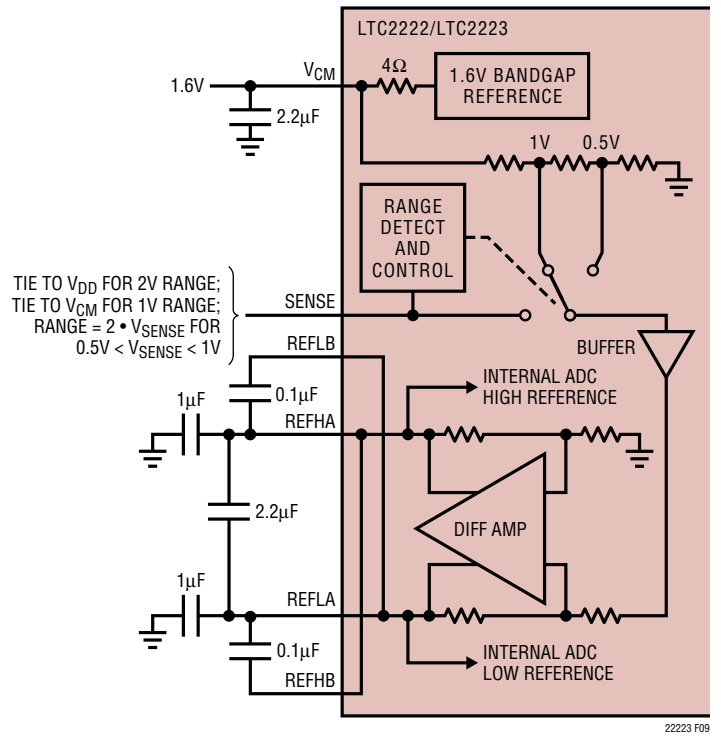

Figure 9. Equivalent Reference Circuit

## APPLICATIONS INFORMATION

### Input Range

The input range can be set based on the application. The 2V input range will provide the best signal-to-noise performance while maintaining excellent SFDR. The 1V input range will have better SFDR performance, but the SNR will degrade by 5dB. See the Typical Performance Characteristics section.

### Driving the Encode Inputs

The noise performance of the LTC2222/LTC2223 can depend on the encode signal quality as much as on the analog input. The ENC<sup>+</sup>/ENC<sup>-</sup> inputs are intended to be driven differentially, primarily for noise immunity from common mode noise sources. Each input is biased through a 6k resistor to a 1.6V bias. The bias resistors set the DC operating point for transformer coupled drive circuits and can set the logic threshold for single-ended drive circuits.

Any noise present on the encode signal will result in additional aperture jitter that will be RMS summed with the inherent ADC aperture jitter.

In applications where jitter is critical (high input frequencies) take the following into consideration:

1. Differential drive should be used.
2. Use as large an amplitude as possible; if transformer coupled use a higher turns ratio to increase the amplitude.
3. If the ADC is clocked with a sinusoidal signal, filter the encode signal to reduce wideband noise.
4. Balance the capacitance and series resistance at both encode inputs so that any coupled noise will appear at both inputs as common mode noise. The encode inputs have a common mode range of 1.1V to 2.5V. Each input may be driven from ground to  $V_{DD}$  for single-ended drive.

### Maximum and Minimum Encode Rates

The maximum encode rate for the LTC2222/LTC2223 is 105MSPs (LTC2222) and 80MSPs (LTC2223). For the ADC to operate properly, the encode signal should have a 50% ( $\pm 5\%$ ) duty cycle. Each half cycle must have at least 4.5ns (LTC2222) or 5.9ns (LTC2223) for the ADC internal circuitry to have enough settling time for proper operation. Achieving a precise 50% duty cycle is easy with differential sinusoidal drive using a transformer or using symmetric differential logic such as PECL or LVDS.

An optional clock duty cycle stabilizer circuit can be used if the input clock has a non 50% duty cycle. This circuit uses the rising edge of the ENC<sup>+</sup> pin to sample the analog input. The falling edge of ENC<sup>+</sup> is ignored and the internal falling edge is generated by a phase-locked loop. The input clock duty cycle can vary from 20% to 80% and the clock duty cycle stabilizer will maintain a constant 50% internal duty cycle. If the clock is turned off for a long period of time, the duty cycle stabilizer circuit will require a hundred clock cycles for the PLL to lock onto the input clock. To use the clock duty cycle stabilizer, the MODE pin should be connected to  $1/3V_{DD}$  or  $2/3V_{DD}$  using external resistors.

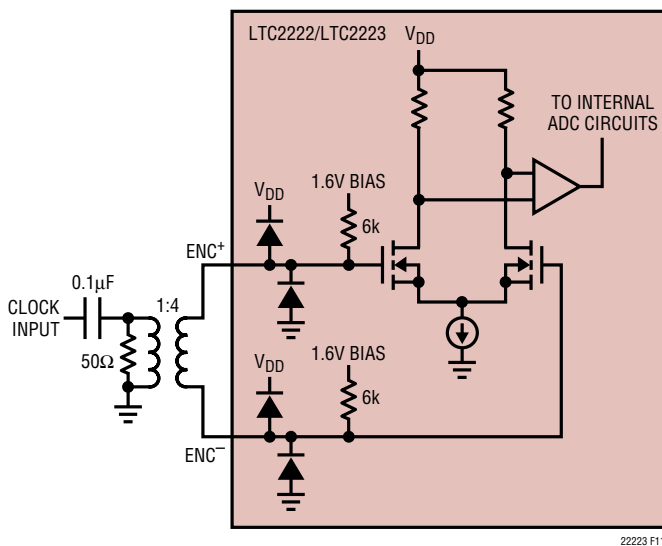

Figure 11. Transformer Driven ENC<sup>+</sup>/ENC<sup>-</sup>

## APPLICATIONS INFORMATION

The lower limit of the LTC2222/LTC2223 sample rate is determined by droop of the sample-and-hold circuits. The pipelined architecture of this ADC relies on storing analog signals on small valued capacitors. Junction leakage will discharge the capacitors. The specified minimum operating frequency for the LTC2222/LTC2223 is 1Msps.

### DIGITAL OUTPUTS

Table 1 shows the relationship between the analog input voltage, the digital data bits and the overflow bit.

**Table 1. Output Codes vs Input Voltage**

$A_{IN}^+ - A_{IN}^-$ (2V Range)	OF	D11 – D0 (Offset Binary)	D11 – D0 (2's Complement)
>+1.000000V	1	1111 1111 1111	0111 1111 1111
+0.999512V	0	1111 1111 1111	0111 1111 1111
+0.999024V	0	1111 1111 1110	0111 1111 1110
+0.000488V	0	1000 0000 0001	0000 0000 0001
0.000000V	0	1000 0000 0000	0000 0000 0000
-0.000488V	0	0111 1111 1111	1111 1111 1111
-0.000976V	0	0111 1111 1110	1111 1111 1110
-0.999512V	0	0000 0000 0001	1000 0000 0001
-1.000000V	0	0000 0000 0000	1000 0000 0000
<-1.000000V	1	0000 0000 0000	1000 0000 0000

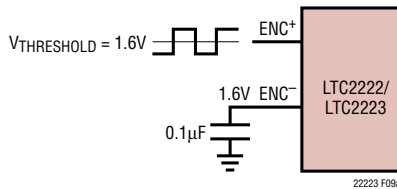

**Figure 12a. Single-Ended ENC Drive, Not Recommended for Low Jitter**

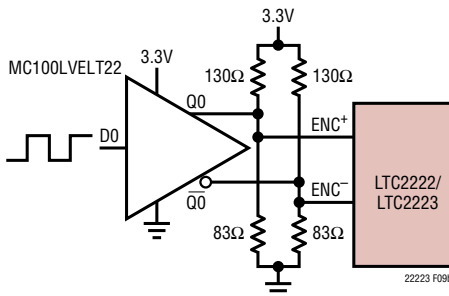

**Figure 12b. ENC Drive Using a CMOS to PECL Translator**

### Digital Output Buffers

Figure 13 shows an equivalent circuit for a single output buffer. Each buffer is powered by  $OV_{DD}$  and  $OGND$ , isolated from the ADC power and ground. The additional N-channel transistor in the output driver allows operation down to low voltages. The internal resistor in series with the output makes the output appear as  $50\Omega$  to external circuitry and may eliminate the need for external damping resistors.

As with all high speed/high resolution converters, the digital output loading can affect the performance. The digital outputs of the LTC2222/LTC2223 should drive a minimal capacitive load to avoid possible interaction between the digital outputs and sensitive input circuitry. The output should be buffered with a device such as an ALVCH16373 CMOS latch. For full speed operation the capacitive load should be kept under 10pF.

Lower  $OV_{DD}$  voltages will also help reduce interference from the digital outputs.

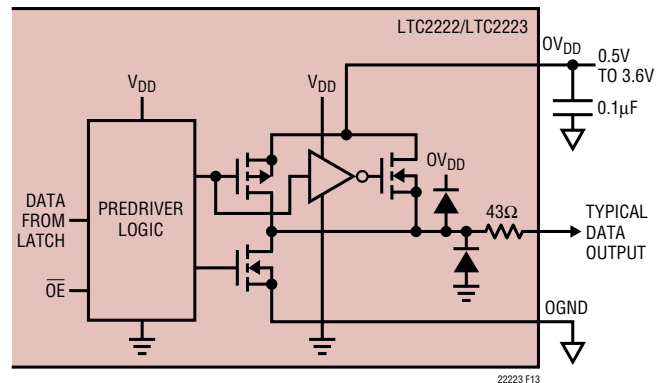

**Figure 13. Digital Output Buffer**

## APPLICATIONS INFORMATION

### Data Format

The LTC2222/LTC2223 parallel digital output can be selected for offset binary or 2's complement format. The format is selected with the MODE pin. Connecting MODE to GND or  $1/3V_{DD}$  selects offset binary output format. Connecting MODE to  $2/3V_{DD}$  or  $V_{DD}$  selects 2's complement output format. An external resistor divider can be used to set the  $1/3V_{DD}$  or  $2/3V_{DD}$  logic values. Table 2 shows the logic states for the MODE pin.

**Table 2. MODE Pin Function**

MODE Pin	Output Format	Clock Duty Cycle Stabilizer
0	Offset Binary	Off
$1/3V_{DD}$	Offset Binary	On
$2/3V_{DD}$	2's Complement	On
$V_{DD}$	2's Complement	Off

### Overflow Bit

When OF outputs a logic high the converter is either overranged or underranged.

### Output Clock

The ADC has a delayed version of the ENC<sup>+</sup> input available as a digital output, CLKOUT. The CLKOUT pin can be used to synchronize the converter data to the digital system. This is necessary when using a sinusoidal encode. Data will be updated just after CLKOUT rises and can be latched on the falling edge of CLKOUT.

### Output Driver Power

Separate output power and ground pins allow the output drivers to be isolated from the analog circuitry. The power supply for the digital output buffers,  $OV_{DD}$ , should be tied to the same power supply as for the logic being driven. For example if the converter is driving a DSP powered by a 1.8V supply then  $OV_{DD}$  should be tied to that same 1.8V supply.

$OV_{DD}$  can be powered with any voltage up to 3.6V.  $OGND$  can be powered with any voltage from GND up to 1V and must be less than  $OV_{DD}$ . The logic outputs will swing between  $OGND$  and  $OV_{DD}$ .

### Output Enable

The outputs may be disabled with the output enable pin,  $\overline{OE}$ .  $\overline{OE}$  high disables all data outputs including OF and CLKOUT. The data access and bus relinquish times are too slow to allow the outputs to be enabled and disabled during full speed operation. The output Hi-Z state is intended for use during long periods of inactivity.

### Sleep and Nap Modes

The converter may be placed in shutdown or nap modes to conserve power. Connecting SHDN to GND results in normal operation. Connecting SHDN to  $V_{DD}$  and  $\overline{OE}$  to  $V_{DD}$  results in sleep mode, which powers down all circuitry including the reference and typically dissipates 1mW. When exiting sleep mode it will take milliseconds for the output data to become valid because the reference capacitors have

## APPLICATIONS INFORMATION

to recharge and stabilize. Connecting SHDN to  $V_{DD}$  and  $\overline{OE}$  to GND results in nap mode, which typically dissipates 35mW. In nap mode, the on-chip reference circuit is kept on, so that recovery from nap mode is faster than that from sleep mode, typically taking 100 clock cycles. In both sleep and nap mode all digital outputs are disabled and enter the Hi-Z state.

### GROUNDING AND BYPASSING

The LTC2222/LTC2223 requires a printed circuit board with a clean unbroken ground plane. A multilayer board with an internal ground plane is recommended. Layout for the printed circuit board should ensure that digital and analog signal lines are separated as much as possible. In particular, care should be taken not to run any digital track alongside an analog signal track or underneath the ADC.

High quality ceramic bypass capacitors should be used at the  $V_{DD}$ ,  $OV_{DD}$ ,  $V_{CM}$ , REFHA, REFHB, REFLA and REFLB pins as shown in the block diagram on the front page of this data sheet. Bypass capacitors must be located as close to the pins as possible. Of particular importance are the capaci-

tors between REFHA and REFLB and between REFHB and REFLA. These capacitors should be as close to the device as possible (1.5mm or less). Size 0402 ceramic capacitors are recommended. The 2.2 $\mu$ F capacitor between REFHA and REFLA can be somewhat further away. The traces connecting the pins and bypass capacitors must be kept short and should be made as wide as possible.

The LTC2222/LTC2223 differential inputs should run parallel and close to each other. The input traces should be as short as possible to minimize capacitance and to minimize noise pickup.

### HEAT TRANSFER

Most of the heat generated by the LTC2222/LTC2223 is transferred from the die through the bottom-side exposed pad and package leads onto the printed circuit board. For good electrical and thermal performance, the exposed pad should be soldered to a large grounded pad on the PC board. It is critical that all ground pins are connected to a ground plane of sufficient area.



## APPLICATIONS INFORMATION

### Clock Sources for Undersampling

Undersampling raises the bar on the clock source and the higher the input frequency, the greater the sensitivity to clock jitter or phase noise. A clock source that degrades SNR of a full-scale signal by 1dB at 70MHz will degrade SNR by 3dB at 140MHz, and 4.5dB at 190MHz.

In cases where absolute clock frequency accuracy is relatively unimportant and only a single ADC is required, a 3V canned oscillator from vendors such as Saronix or Vectron can be placed close to the ADC and simply connected directly to the ADC. If there is any distance to the ADC, some source termination to reduce ringing that may occur even over a fraction of an inch is advisable. You must not allow the clock to overshoot the supplies or performance will suffer. Do not filter the clock signal with a narrow band filter unless you have a sinusoidal clock source, as the rise and fall time artifacts present in typical digital clock signals will be translated into phase noise.

The lowest phase noise oscillators have single-ended sinusoidal outputs, and for these devices the use of a filter close to the ADC may be beneficial. This filter should be close to the ADC to both reduce roundtrip reflection times, as well as reduce the susceptibility of the traces between the filter and the ADC. If you are sensitive to close-in phase noise, the power supply for oscillators and any buffers

must be very stable, or propagation delay variation with supply will translate into phase noise. Even though these clock sources may be regarded as digital devices, do not operate them on a digital supply. If your clock is also used to drive digital devices such as an FPGA, you should locate the oscillator, and any clock fan-out devices close to the ADC, and give the routing to the ADC precedence. The clock signals to the FPGA should have series termination at the source to prevent high frequency noise from the FPGA disturbing the substrate of the clock fan-out device. If you use an FPGA as a programmable divider, you must re-time the signal using the original oscillator, and the re-timing flip-flop as well as the oscillator should be close to the ADC, and powered with a very quiet supply.

For cases where there are multiple ADCs, or where the clock source originates some distance away, differential clock distribution is advisable. This is advisable both from the perspective of EMI, but also to avoid receiving noise from digital sources both radiated, as well as propagated in the waveguides that exist between the layers of multi-layer PCBs. The differential pairs must be close together, and distanced from other signals. The differential pair should be guarded on both sides with copper distanced at least 3x the distance between the traces, and grounded with vias no more than 1/4 inch apart.



# APPLICATIONS INFORMATION

## Evaluation Circuit Schematic of the LTC2222

www.datasheet4u.com

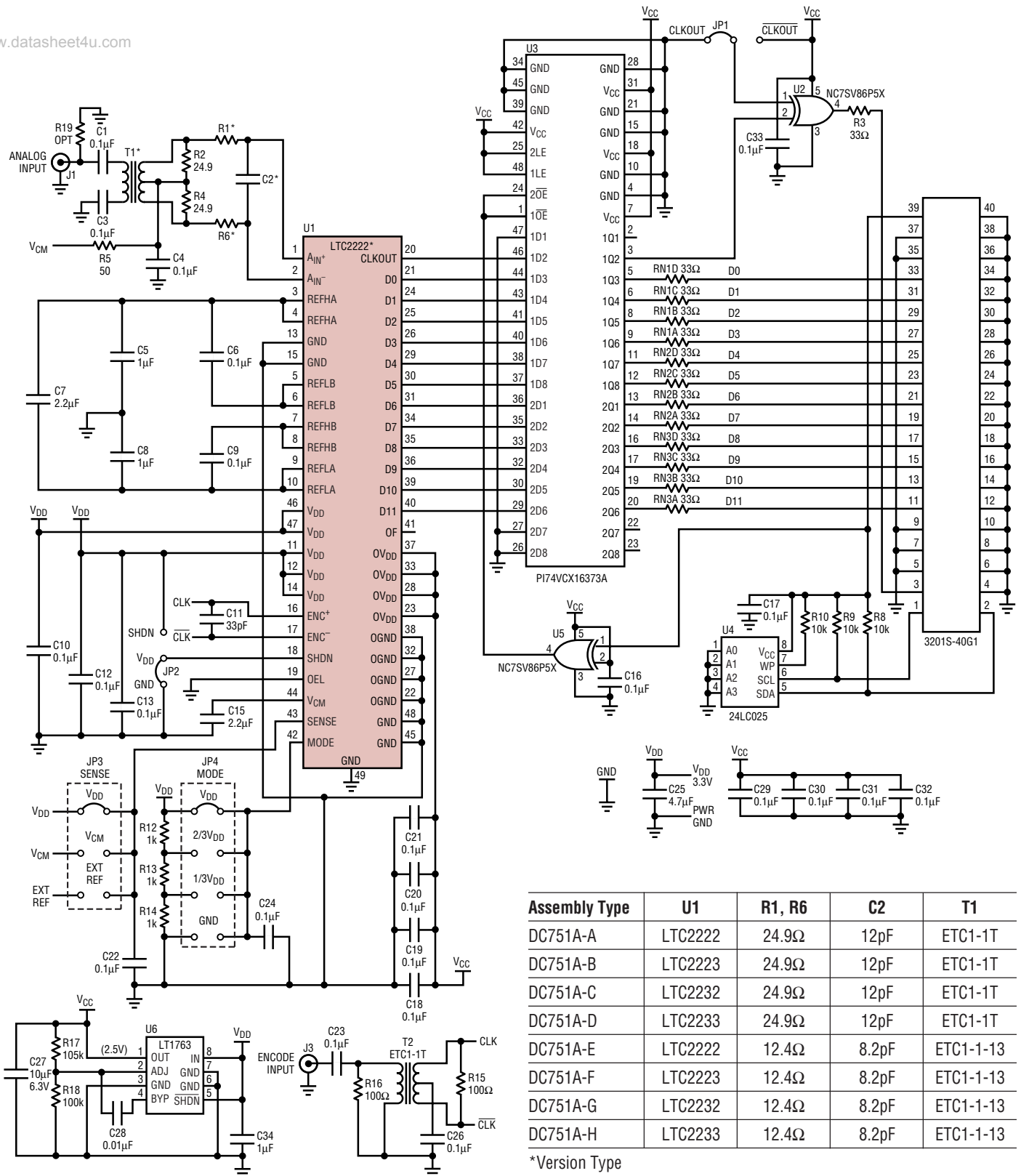

Assembly Type	U1	R1, R6	C2	T1
DC751A-A	LTC2222	24.9Ω	12pF	ETC1-1T
DC751A-B	LTC2223	24.9Ω	12pF	ETC1-1T
DC751A-C	LTC2232	24.9Ω	12pF	ETC1-1T
DC751A-D	LTC2233	24.9Ω	12pF	ETC1-1T
DC751A-E	LTC2222	12.4Ω	8.2pF	ETC1-1-13
DC751A-F	LTC2223	12.4Ω	8.2pF	ETC1-1-13
DC751A-G	LTC2232	12.4Ω	8.2pF	ETC1-1-13
DC751A-H	LTC2233	12.4Ω	8.2pF	ETC1-1-13

\*Version Type

22223fa

## APPLICATIONS INFORMATION

Silkscreen Top

www.datasheet4u.com

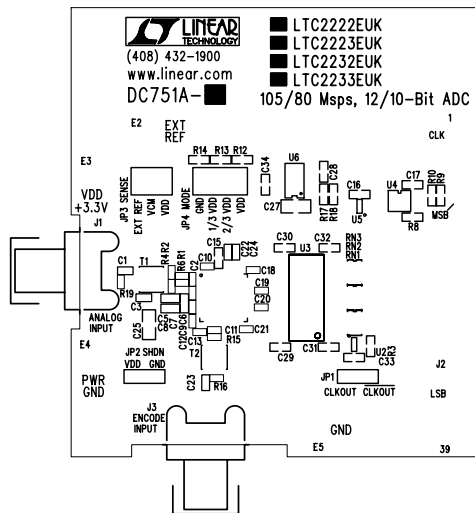

Layer 1 Component Side

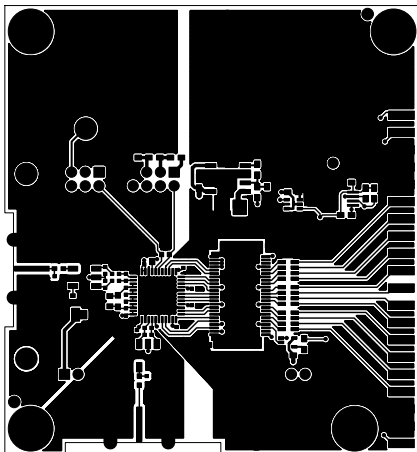

Layer 2 GND Plane

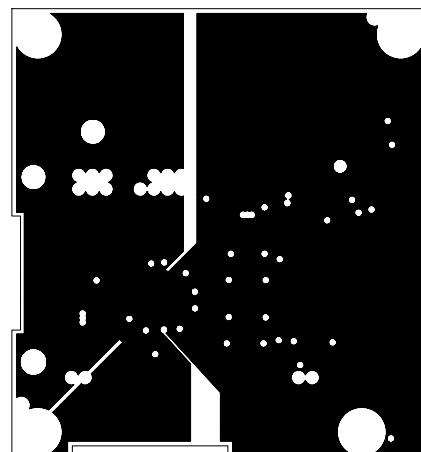

Layer 3 Power Plane

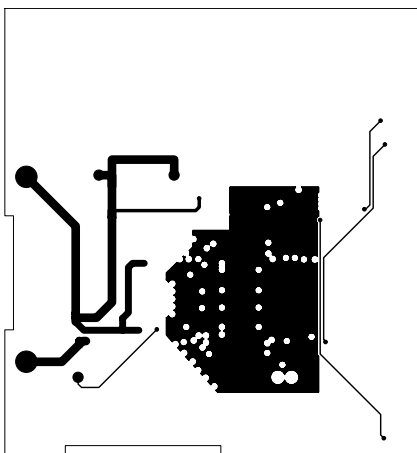

Layer 4 Bottom Side

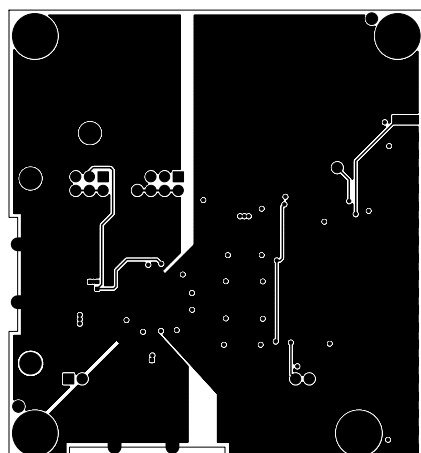

22223fa

# PACKAGE DESCRIPTION

www.datasheet4u.com

## UK Package 48-Lead Plastic QFN (7mm × 7mm) (Reference LTC DWG # 05-08-1704)

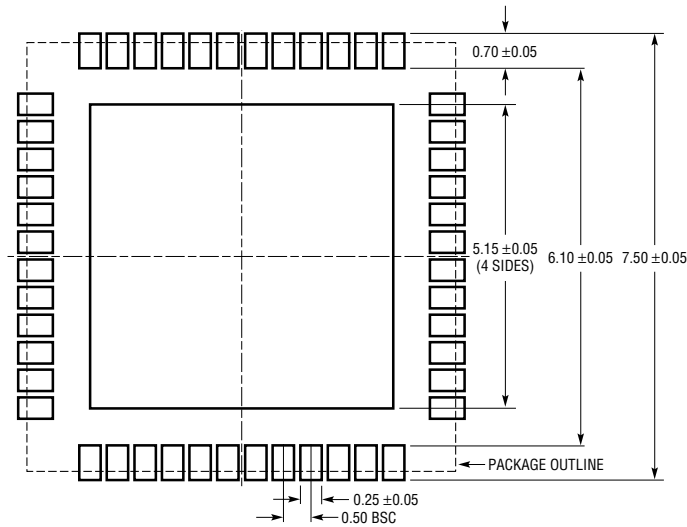

- NOTE:
1. DRAWING CONFORMS TO JEDEC PACKAGE OUTLINE MO-220 VARIATION (WKKD-2)
  2. ALL DIMENSIONS ARE IN MILLIMETERS
  3. DIMENSIONS OF EXPOSED PAD ON BOTTOM OF PACKAGE DO NOT INCLUDE MOLD FLASH. MOLD FLASH, IF PRESENT, SHALL NOT EXCEED 0.20mm ON ANY SIDE, IF PRESENT
  4. EXPOSED PAD SHALL BE SOLDER PLATED
  5. SHADED AREA IS ONLY A REFERENCE FOR PIN 1 LOCATION ON THE TOP AND BOTTOM OF PACKAGE

RECOMMENDED SOLDER PAD PITCH AND DIMENSIONS

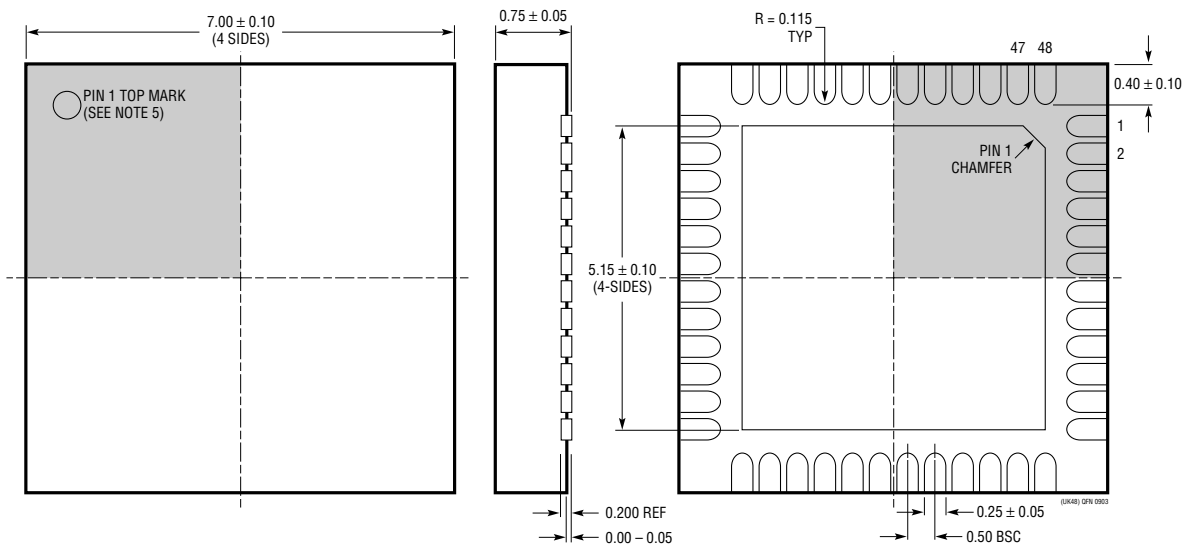

BOTTOM VIEW—EXPOSED PAD

## RELATED PARTS

PART NUMBER	DESCRIPTION	COMMENTS
LTC1748	14-Bit, 80Msps, 5V ADC	76.3dB SNR, 90dB SFDR, 48-Pin TSSOP Package
LTC1750	14-Bit, 80Msps, 5V Wideband ADC	Up to 500MHz IF Undersampling, 90dB SFDR
LT1993-2	High Speed Differential Op Amp	800MHz BW, 70dBc Distortion at 70MHz, 6dB Gain
LT1994	Low Noise, Low Distortion Fully Differential Input/Output Amplifier/Driver	Low Distortion: -94dBc at 1MHz
LTC2202	16-Bit, 10Msps, 3.3V ADC, Lowest Noise	150mW, 81.6dB SNR, 100dB SFDR, 48-Pin QFN
LTC2208	16-Bit, 130Msps, 3.3V ADC, LVDS Outputs	1250mW, 78dB SNR, 100dB SFDR, 64-Pin QFN
LTC2220-1	12-Bit, 185Msps, 3.3V ADC, LVDS Outputs	910mW, 67.7dB SNR, 80dB SFDR, 64-Pin QFN
LTC2222	12-Bit, 105Msps, 3.3V ADC, High IF Sampling	475mW, 68.4dB SNR, 84dB SFDR, 48-Pin QFN
LTC2222-11	11-Bit, 105Msps, 3.3V ADC, High IF Sampling	475mW, 65.7dB SNR, 84dB SFDR, 48-Pin QFN
LTC2223	12-Bit, 80Msps, 3.3V ADC, High IF Sampling	366mW, 68.5dB SNR, 84dB SFDR, 48-Pin QFN
LTC2224	12-Bit, 135Msps, 3.3V ADC, High IF Sampling	630mW, 67.6dB SNR, 84dB SFDR, 48-Pin QFN
LTC2232	10-Bit, 105Msps, 3.3V ADC, High IF Sampling	475mW, 61.3dB SNR, 78dB SFDR, 48-Pin QFN
LTC2233	10-Bit, 80Msps, 3.3V ADC, High IF Sampling	366mW, 61.3dB SNR, 78dB SFDR, 48-Pin QFN
LTC2234	10-Bit, 135Msps, 3.3V ADC, High IF Sampling	630mW, 61.2dB SNR, 78dB SFDR, 48-Pin QFN
LTC2255	14-Bit, 125Msps, 3V ADC, Lowest Power	395mW, 72.5dB SNR, 88dB SFDR, 32-Pin QFN
LTC2284	14-Bit, Dual, 105Msps, 3V ADC, Low Crosstalk	540mW, 72.4dB SNR, 88dB SFDR, 64-Pin QFN
LT5512	DC-3GHz High Signal Level Downconverting Mixer	DC to 3GHz, 21dBm IIP3, Integrated LO Buffer
LT5514	Ultralow Distortion IF Amplifier/ADC Driver with Digitally Controlled Gain	450MHz 1dB BW, 47dB OIP3, Digital Gain Control 10.5dB to 33dB in 1.5dB/Step
LT5515	1.5GHz to 2.5GHz Direct Conversion Quadrature Demodulator	High IIP3: 20dBm at 1.9GHz, Integrated LO Quadrature Generator
LT5516	800MHz to 1.5GHz Direct Conversion Quadrature Demodulator	High IIP3: 21.5dBm at 900MHz, Integrated LO Quadrature Generator
LT5517	40MHz to 900MHz Direct Conversion Quadrature Demodulator	High IIP3: 21dBm at 800MHz, Integrated LO Quadrature Generator
LT5522	600MHz to 2.7GHz High Linearity Downconverting Mixer	4.5V to 5.25V Supply, 25dBm IIP3 at 900MHz, NF = 12.5dB, 500Ω Single-Ended RF and LO Ports