

Low Power 8th Order Pin Selectable Elliptic or Linear Phase Lowpass Filter

FEATURES

- 8th Order Pin Selectable Elliptic or Bessel Filter in a 14-Pin Package
- 4mA Supply Current with $\pm 5V$ Supplies
- 64dB Attenuation at $1.44 f_{CUTOFF}$ (Elliptic Response)
- f_{CUTOFF} up to 30kHz (50:1 f_{CLK} to f_{CUTOFF} Ratio)
- $110\mu V_{RMS}$ Wideband Noise with $\pm 5V$ Supplies
- Operates at Single 5V Supply with $1V_{RMS}$ Input Range
- Operates up to $\pm 8V$ Supplies
- TTL/CMOS Compatible Clock Input
- No External Components

APPLICATIONS

- Anti-Aliasing Filters
- Battery-Operated Instruments
- Telecommunication Filters

DESCRIPTION

The LTC1164-6 is a monolithic 8th order elliptic lowpass filter featuring clock-tunable cutoff frequency and low power supply current. Low power operation is achieved without compromising noise or distortion performance. At $\pm 5V$ supplies the LTC1164-6 uses only 4mA supply current while keeping wideband noise below $110\mu V_{RMS}$. With a single 5V supply, the LTC1164-6 can provide up to 10kHz cutoff frequency and 80dB signal-to-noise ratio while consuming only 2.5mA.

The LTC1164-6 provides an elliptic lowpass rolloff with stopband attenuation of 64dB at $1.44 f_{CUTOFF}$ and an f_{CLK} -to- f_{CUTOFF} ratio of 100:1 (pin 10 to V^-). For a ratio of 100:1, f_{CUTOFF} can be clock-tuned up to 10kHz. For a f_{CLK} -to- f_{CUTOFF} ratio of 50:1 (pin 10 to V^+), the LTC1164-6 provides an elliptic lowpass filter with f_{CUTOFF} frequencies up to 20kHz. When pin 10 is connected to ground, the LTC1164-6 approximates an 8th order linear phase response with 65dB attenuation at $4.5 f_{-3dB}$ and f_{CLK}/f_{-3dB} ratio of 160:1. The LTC1164-6 is pin compatible with the LTC1064-1.

TYPICAL APPLICATION

10kHz Anti-Aliasing Elliptic Filter

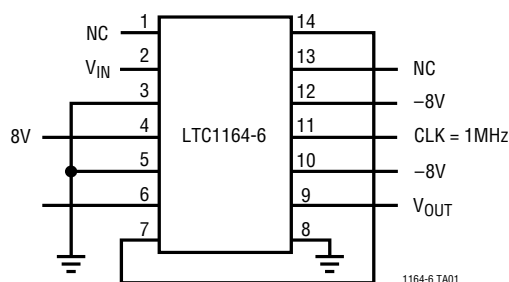

WIDEBAND NOISE = $115\mu V_{RMS}$

NOTE: THE CONNECTION FROM PIN 7 TO PIN 14 SHOULD BE MADE UNDER THE PACKAGE. THE POWER SUPPLIES SHOULD BE BYPASSED BY A $0.1\mu F$ CAPACITOR AS CLOSE TO THE PACKAGE AS POSSIBLE.

Frequency Response

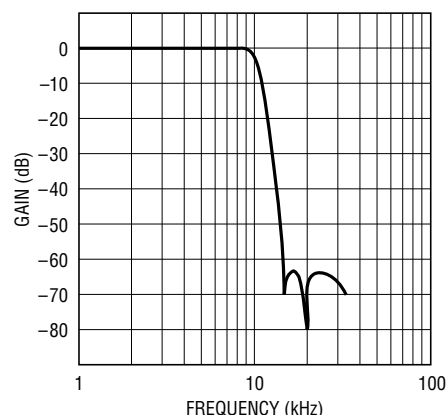

1164-6 TA02

LTC1164-6

ABSOLUTE MAXIMUM RATINGS (Note 1)

Total Supply Voltage (V^+ to V^-)	16V	Operating Temperature Range	
Input Voltage (Note 2)	($V^+ + 0.3V$) to ($V^- - 0.3V$)	LTC1164-6C	-40°C to 85°C
Output Short-Circuit Duration	Indefinite	LTC1164-6M	-55°C to 125°C
Power Dissipation	400mW	Storage Temperature Range	-65°C to 150°C
Burn-In Voltage	16V	Lead Temperature (Soldering, 10 sec)	300°C

PACKAGE/ORDER INFORMATION

<p>J PACKAGE 14-LEAD CERAMIC DIP</p> <p>N PACKAGE 14-LEAD PLASTIC DIP</p> <p>$T_{JMAX} = 150^\circ\text{C}$, $\theta_{JA} = 65^\circ\text{C/W}$ (J) $T_{JMAX} = 110^\circ\text{C}$, $\theta_{JA} = 65^\circ\text{C/W}$ (N)</p>	<p>ORDER PART NUMBER</p> <p>LTC1164-6CN LTC1164-6CJ LTC1164-6MJ</p>	<p>S PACKAGE 16-LEAD PLASTIC SOL</p> <p>$T_{JMAX} = 110^\circ\text{C}$, $\theta_{JA} = 85^\circ\text{C/W}$</p>	<p>ORDER PART NUMBER</p> <p>LTC1164-6CS</p>
--	---	--	---

ELECTRICAL CHARACTERISTICS

$V_S = \pm 7.5V$, $R_L = 10k$, $T_A = 25^\circ\text{C}$, $f_{CLK} = 400kHz$, TTL or CMOS level (maximum clock rise or fall time $\leq 1\mu s$) and all gain measurements are referenced to passband gain, unless otherwise specified. (f_{CLK}/f_{CUTOFF}) = 4kHz at 100:1 and 8kHz at 50:1.

PARAMETER	CONDITIONS	MIN	TYP	MAX	UNITS
Passband Gain 0.1Hz to 0.25 f_{CUTOFF} (Note 4)	$f_{IN} = 1kHz$, (f_{CLK}/f_C) = 100:1	-0.50	-0.15	0.25	dB
Passband Ripple with $V_S = \text{Single } 5V$	1Hz to 0.8 f_C (Table 2)		0.1 to -0.3		dB
Gain at 0.50 f_{CUTOFF} (Note 3)	$f_{IN} = 2kHz$, (f_{CLK}/f_C) = 100:1	-0.45	-0.10	0.10	dB
Gain at 0.90 f_{CUTOFF} (Note 3)	$f_{IN} = 3.6kHz$, (f_{CLK}/f_C) = 100:1	-0.75	-0.30	0.10	dB
Gain at 0.95 f_{CUTOFF} (Note 3)	$f_{IN} = 3.8kHz$, (f_{CLK}/f_C) = 100:1	-1.40	-0.70	-0.40	dB
Gain at f_{CUTOFF} (Note 3)	$f_{IN} = 4kHz$, (f_{CLK}/f_C) = 100:1	-3.50	-2.70	-2.30	dB
	$f_{IN} = 8kHz$, (f_{CLK}/f_C) = 50:1	-3.00	-2.10	-1.50	dB
Gain at 1.44 f_{CUTOFF} (Note 3)	$f_{IN} = 5.76kHz$, (f_{CLK}/f_C) = 100:1	-69	-64	-58	dB
Gain at 2.0 f_{CUTOFF} (Note 3)	$f_{IN} = 8kHz$, (f_{CLK}/f_C) = 100:1	-69	-64	-58	dB
Gain with $f_{CLK} = 20kHz$	$f_{IN} = 200Hz$, (f_{CLK}/f_C) = 100:1	-3.50	-2.70	-2.30	dB
Gain with $V_S = \pm 2.375V$	$f_{IN} = 400kHz$, $f_{IN} = 2kHz$, (f_{CLK}/f_C) = 100:1	-0.50	-0.10	0.30	dB
	$f_{IN} = 400kHz$, $f_{IN} = 4kHz$, (f_{CLK}/f_C) = 100:1	-3.30	-2.50	-2.00	dB
Input Frequency Range (Tables 3, 4)	(f_{CLK}/f_C) = 100:1		0 - $<f_{CLK}/2$		kHz
	(f_{CLK}/f_C) = 50:1		0 - $<f_{CLK}$		kHz
Maximum f_{CLK} (Table 3)	$V_S \geq \pm 7.5V$		1.5		MHz
	$V_S \leq \pm 5V$		1.0		MHz
	$V_S = \text{Single } 5V$, AGND = 2V		1.0		MHz

ELECTRICAL CHARACTERISTICS

$V_S = \pm 7.5V$, $R_L = 10k$, $T_A = 25^\circ C$, $f_{CLK} = 400kHz$, TTL or CMOS level (maximum clock rise or fall time $\leq 1\mu s$) and all gain measurements are referenced to passband gain, unless otherwise specified. $(f_{CLK}/f_{CUTOFF}) = 4kHz$ at 100:1 and 8kHz at 50:1.

PARAMETER	CONDITIONS	MIN	TYP	MAX	UNITS
Clock Feedthrough	Input at GND, $f = f_{CLK}$, Square Wave $V_S = \pm 7.5V$, $(f_{CLK}/f_C) = 100:1$ $V_S = \pm 5V$, $(f_{CLK}/f_C) = 50:1$		500 200		μV_{RMS} μV_{RMS}
Wideband Noise	Input at GND, $1Hz \leq f < f_{CLK}$ $V_S = \pm 7.5V$ $V_S = \pm 2.5V$		$115 \pm 5\%$ $100 \pm 5\%$		μV_{RMS} μV_{RMS}
Input Impedance		30	40	70	k Ω
Output DC Voltage Swing	$V_S = \pm 2.375V$ $V_S = \pm 5V$ $V_S = \pm 7.5V$	● ± 1.25 ● ± 3.70 ● ± 5.40	± 1.50 ± 4.10 ± 5.90		V V V
Output DC Offset	$V_S = \pm 5V$, $(f_{CLK}/f_C) = 100:1$		± 100	± 160	mV
Output DC Offset TempCo	$V_S = \pm 5V$, $(f_{CLK}/f_C) = 100:1$		± 100		$\mu V/^\circ C$
Power Supply Current	$V_S = \pm 2.375V$, $T_A > 25^\circ C$ $V_S = \pm 5V$, $T_A > 25^\circ C$ $V_S = \pm 7.5V$, $T_A > 25^\circ C$	● ● ●	2.5 4.5 7.0	4.0 7.0 11.0	mA mA mA
Power Supply Range			± 2.375	± 8	V

The ● denotes specifications which apply over the full operating temperature range.

Note 1: Absolute Maximum Ratings are those values beyond which life of the device may be impaired.

Note 2: Connecting any pin to voltages greater than V^+ or less than V^-

may cause latch-up. It is recommended that no sources operating from external supplies be applied prior to power-up of the LTC1164-6.

Note 3: All gains are measured relative to passband gain.

Note 4: The cutoff frequency of the filter is abbreviated as f_{CUTOFF} or f_C .

TYPICAL PERFORMANCE CHARACTERISTICS

Stopband Gain vs Frequency
(Elliptic Response)

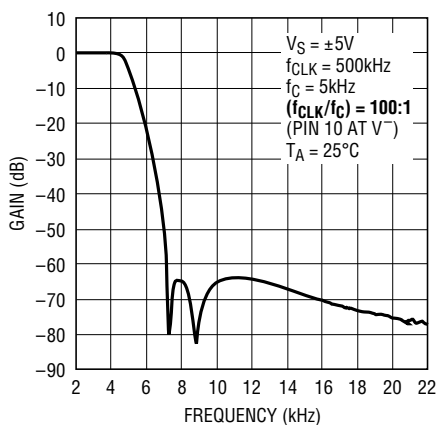

1164-6 G01

Stopband Gain vs Frequency
(Elliptic Response)

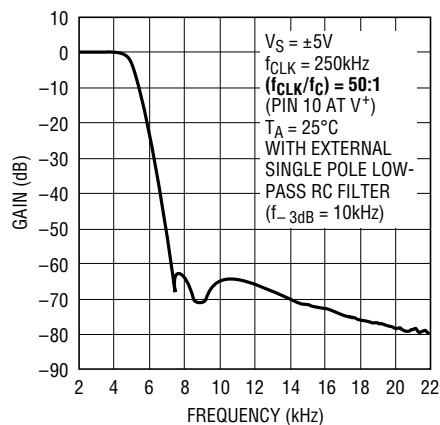

1164-6 G02

TYPICAL PERFORMANCE CHARACTERISTICS

Stopband Gain vs Frequency (Linear Phase Response)

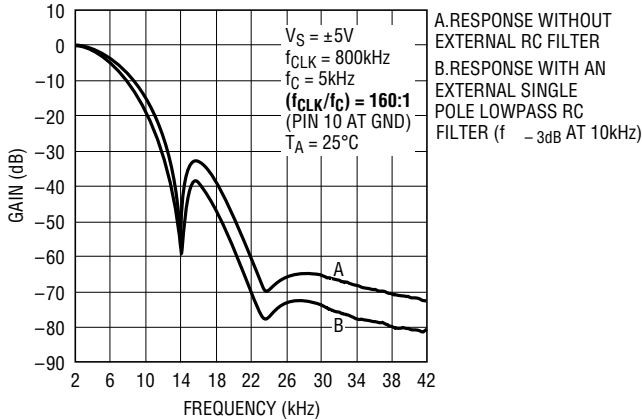

1164-6 G03

Passband Gain and Phase vs Frequency

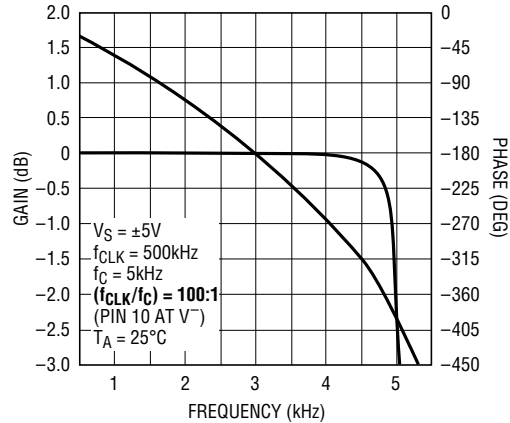

1164-6 G04

Passband Gain vs Frequency

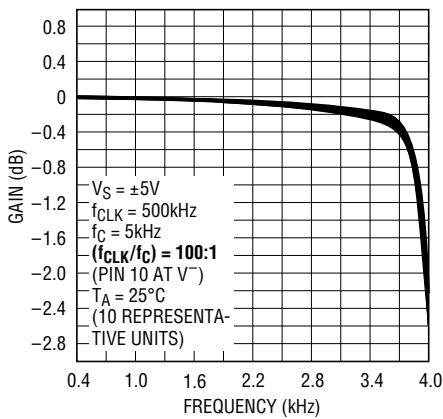

1164-6 G05

Passband Gain and Phase vs Frequency (Linear Phase Response)

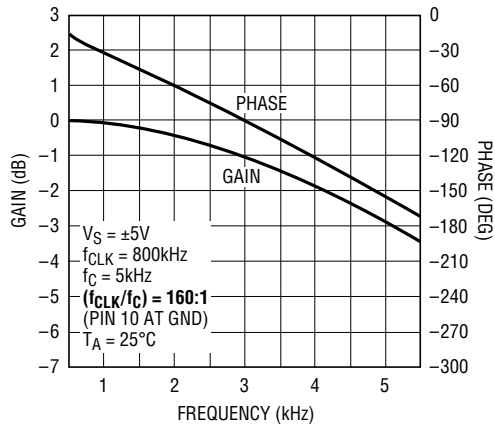

1164-6 G11

Maximum Passband over Temperature

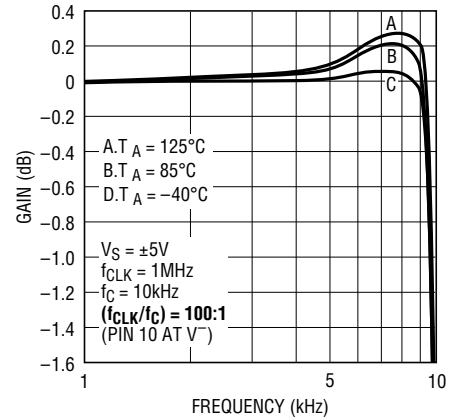

1164-6 G07

Passband vs Frequency and fCLK

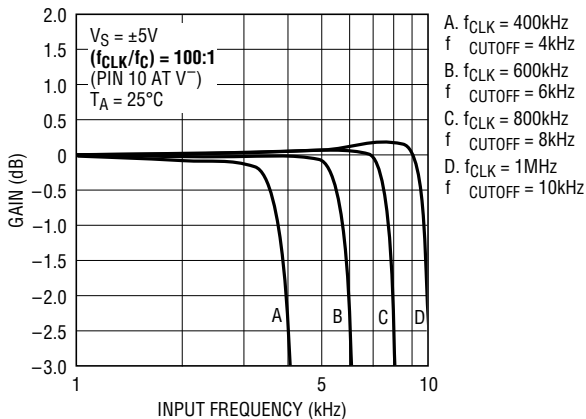

1164-6 G06

Passband Gain and Phase vs Frequency and fCLK

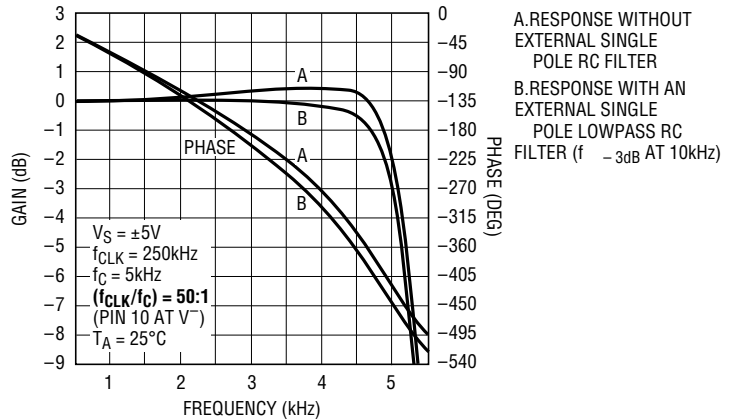

1164-6 G08

TYPICAL PERFORMANCE CHARACTERISTICS

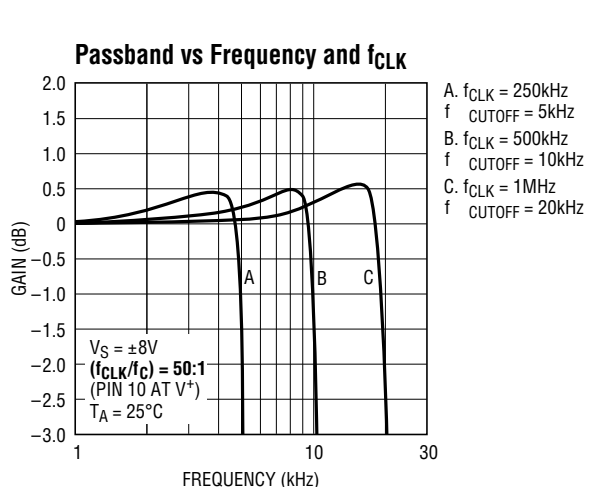

1164-6 G09

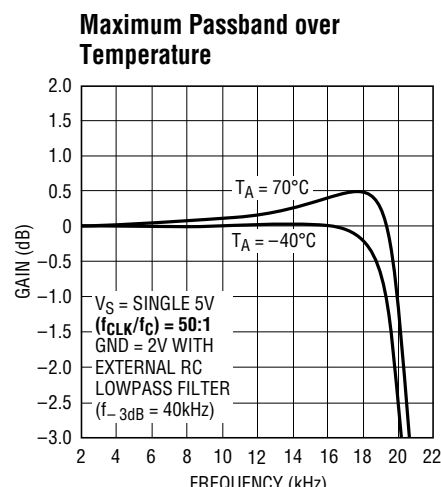

1164-6 G10

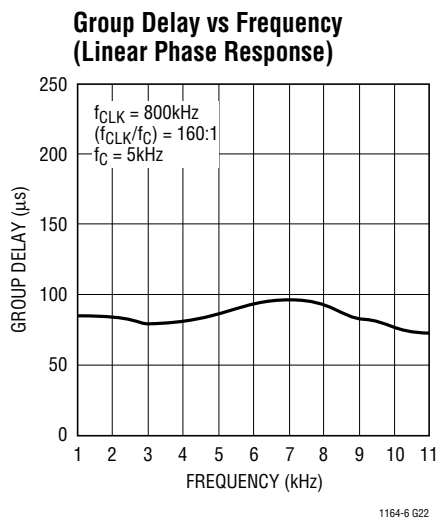

1164-6 G22

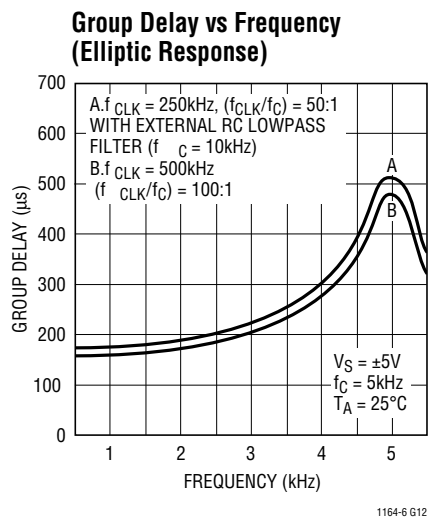

1164-6 G12

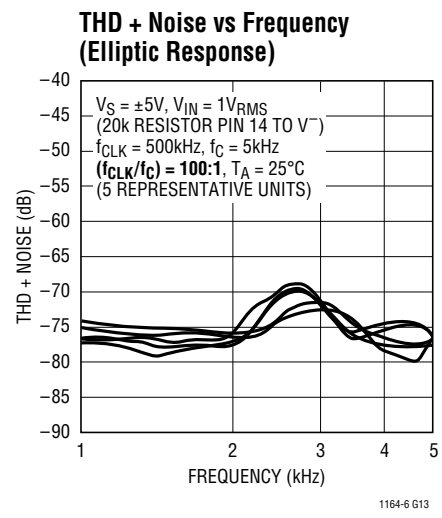

1164-6 G13

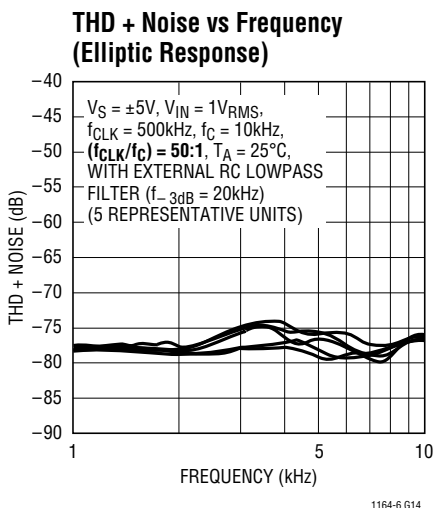

1164-6 G14

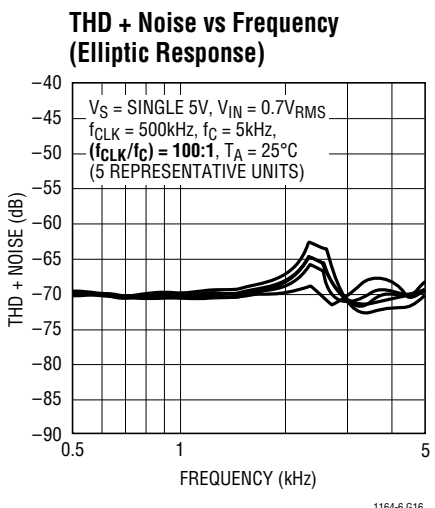

1164-6 G16

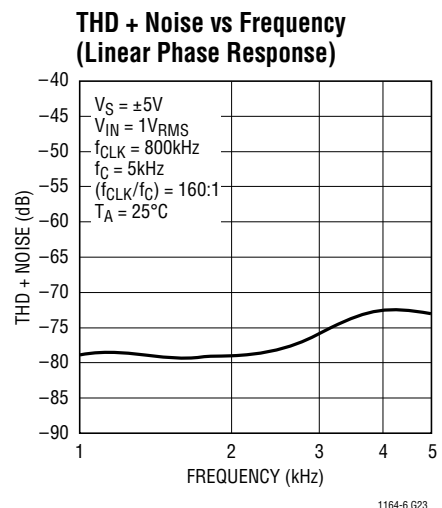

1164-6 G23

TYPICAL PERFORMANCE CHARACTERISTICS

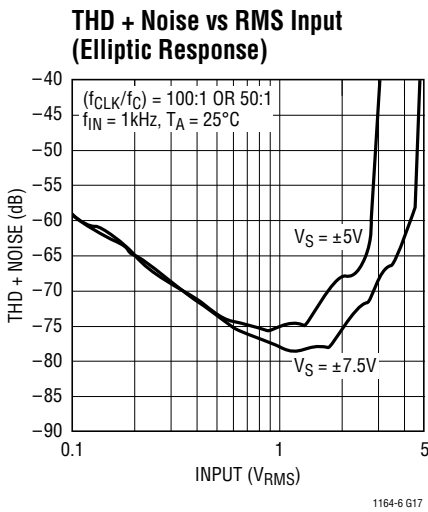

1164-6 G17

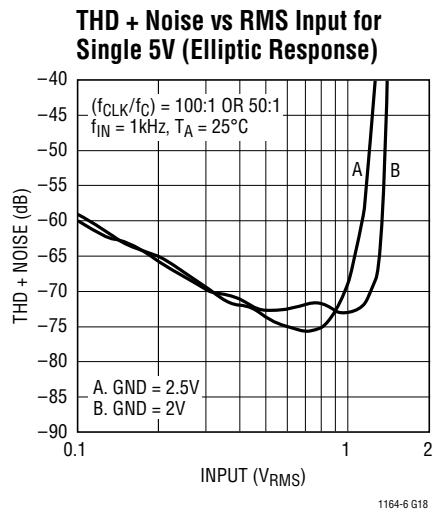

1164-6 G18

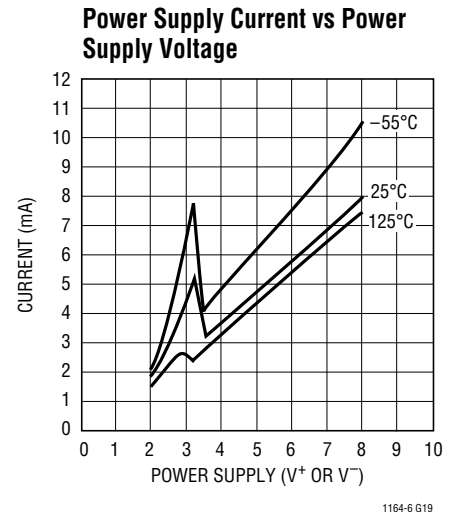

1164-6 G19

Transient Response

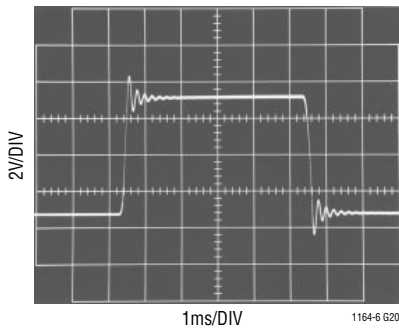

1164-6 G20

$V_S = \pm 7.5\text{V}$, $V_{IN} = \pm 3\text{V}$ 100Hz SQUARE WAVE
 $f_{CLK} = 500\text{kHz}$, $(f_{CLK}/f_C) = 100:1$, $f_{CUTOFF} = 5\text{kHz}$
 ELLIPTIC RESPONSE

Transient Response

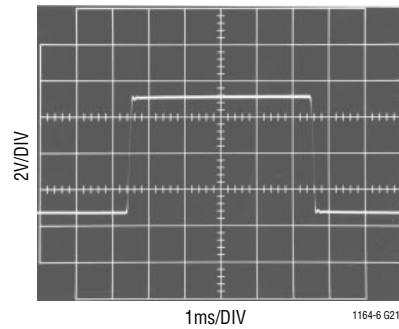

1164-6 G21

$V_S = \pm 7.5\text{V}$, $V_{IN} = \pm 3\text{V}$ 100Hz SQUARE WAVE
 $f_{CLK} = 800\text{kHz}$, $(f_{CLK}/f_C) = 160:1$, $f_{CUTOFF} = 5\text{kHz}$
 LINEAR PHASE RESPONSE

PIN FUNCTIONS (14-Lead Dual-In-Line Package)

Power Supply Pins (4, 12)

The V^+ (pin 4) and the V^- (pin 12) should be bypassed with a $0.1\mu\text{F}$ capacitor to an adequate analog ground. The filter's power supplies should be isolated from other digital or high voltage analog supplies. A low noise linear supply is recommended. Using a switching power supply will lower the signal-to-noise ratio of the filter. The supply during power-up should have a slew rate less than $1\text{V}/\mu\text{s}$. When V^+ is applied before V^- and V^- could go above ground, a signal diode must be used to clamp V^- . Figures

1 and 2 show typical connections for dual and single supply operation.

Clock Input Pin (11)

Any TTL or CMOS clock source with a square-wave output and 50% duty cycle ($\pm 10\%$) is an adequate clock source for the device. The power supply for the clock source should not be the filter's power supply. The analog ground for the filter should be connected to clock's ground at a single point only. Table 1 shows the clock's low and high

PIN FUNCTIONS (14-Lead Dual-In-Line Package)

can be used provided that its input common-mode range is well within the filter's output swing. Pin 6 is an intermediate filter output providing an unspecified 6th order lowpass filter. Pin 6 should not be loaded.

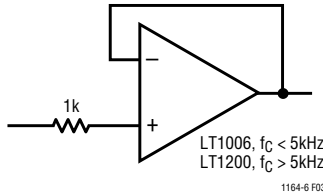

Figure 3. Buffer for Filter Output

External Connection Pins (7, 14)

Pins 7 and 14 should be connected together. In a printed circuit board the connection should be done under the IC package through a short trace surrounded by the analog ground plane.

NC Pin (1, 8, 13)

Pins 1, 8, and 13 are not connected to any internal circuit point on the device and should preferably be tied to analog ground.

APPLICATIONS INFORMATION

Passband Response

The passband response of the LTC1164-6 is optimized for a f_{CLK}/f_{CUTOFF} ratio of 100:1. Minimum passband ripple occurs from 1Hz to 80% of f_{CUTOFF} . Although the passband of the LTC1164-6 is optimized for ratio f_{CLK}/f_{CUTOFF} of 100:1, if a ratio of 50:1 is desired, connect a single pole lowpass RC ($f_{-3dB} = 2 f_{CUTOFF}$) at the output of the filter. The RC will make the passband gain response as flat as the 100:1 case. If the RC is omitted, and clock frequencies are below 500kHz the passband gain will peak by 0.4dB at 90% f_{CUTOFF} .

Table 2. Typical Passband Ripple with Single 5V Supply ($f_{CLK}/f_C = 100:1$, GND = 2V, 30kHz, Fixed Single Pole, Lowpass RC Filter at Pin 9 (See Typical Applications))

PASSBAND FREQUENCY	PASSBAND GAIN (REFERENCED TO 0dB)			
	$f_{CUTOFF} = 1kHz$	$f_{CUTOFF} = 10kHz$		
		$T_A = 25^\circ C$ (dB)	$T_A = 0^\circ C$ (dB)	$T_A = 25^\circ C$ (dB)
% of f_{CUTOFF}				
10	0.00	0.00	0.00	0.00
20	-0.02	0.00	0.01	0.01
30	-0.05	-0.01	-0.01	0.01
40	-0.10	-0.02	-0.02	0.02
50	-0.13	-0.03	-0.01	0.03
60	-0.15	-0.01	0.01	0.05
70	-0.18	-0.01	0.01	0.07
80	-0.25	-0.08	-0.05	0.02
90	-0.39	-0.23	-0.18	-0.05
f_{CUTOFF}	-2.68	-2.79	-2.74	-2.68

The gain peaking can approximate a $\sin \chi/\chi$ correction for some applications. (See Typical Performance Characteristics curve, Passband vs Frequency and f_{CLK} at $f_{CLK}/f_C = 50:1$.)

When the LTC1164-6 operates with a single 5V supply and its cutoff frequency is clock-tuned to 10kHz, an output single pole RC filter can also help maintain outstanding passband flatness from 0°C to 70°C. Table 2 shows details.

Clock Feedthrough

Clock feedthrough is defined as, the RMS value of the clock frequency and its harmonics that are present at the filter's output pin (9). The clock feedthrough is tested with the input pin (2) grounded and, it depends on PC board layout and on the value of the power supplies. With proper layout techniques the values of the clock feedthrough are shown in Table 3.

Table 3. Clock Feedthrough

V_S	50:1	100:1
$\pm 2.5V$	60 μV_{RMS}	60 μV_{RMS}
$\pm 5V$	100 μV_{RMS}	200 μV_{RMS}
$\pm 7.5V$	150 μV_{RMS}	500 μV_{RMS}

Note: The clock feedthrough at $\pm 2.5V$ supplies is imbedded in the wideband noise of the filter. (The clock signal is a square wave.)

APPLICATIONS INFORMATION

Any parasitic switching transients during the rise and fall edges of the incoming clock are not part of the clock feedthrough specifications. Switching transients have frequency contents much higher than the applied clock; their amplitude strongly depends on scope probing techniques as well as grounding and power supply bypassing. The clock feedthrough, if bothersome, can be greatly reduced by adding a simple R/C lowpass network at the output of the filter pin (9). This R/C will completely eliminate any switching transient.

Wideband Noise

The wideband noise of the filter is the total RMS value of the device's noise spectral density and it is used to determine the operating signal-to-noise ratio. Most of its frequency contents lie within the filter passband and it cannot be reduced with post filtering. For instance, the LTC1164-6 wideband noise at $\pm 2.5V$ supply is $100\mu V_{RMS}$, $90\mu V_{RMS}$ of which have frequency contents from DC up to the filter's cutoff frequency. The total wideband noise (μV_{RMS}) is nearly independent of the value of the clock. The clock feedthrough specifications are not part of the wideband noise.

Speed Limitations

The LTC1164-6 optimizes AC performance versus power consumption. To avoid op amp slew rate limiting at maximum clock frequencies, the signal amplitude should be kept below a specified level as shown on Table 4.

Aliasing

Aliasing is an inherent phenomenon of sampled data systems and it occurs when input frequencies close to the sampling frequency are applied. For the LTC1164-6 case, an input signal whose frequency is in the range of $f_{CLK} \pm 4\%$, will be aliased back into the filter's passband. If, for instance, an LTC1164-6 operating with a 100kHz clock and 1kHz cutoff frequency receives a 98.5kHz, $10mV_{RMS}$ input signal, a 1.5kHz, $10\mu V_{RMS}$ alias signal will appear at its output. When the LTC1164-6 operates with a clock-to-cutoff frequency of 50:1, aliasing occurs at twice the clock frequency. Table 5 shows details.

Table 4. Maximum V_{IN} vs V_S and f_{CLK}

POWER SUPPLY	MAXIMUM f_{CLK}	MAXIMUM V_{IN}
$\pm 7.5V$	1.5MHz 1MHz $\geq 1MHz$	$1V_{RMS}$ ($f_{IN} > 35kHz$) $3V_{RMS}$ ($f_{IN} > 25kHz$) $0.7V_{RMS}$ ($f_{IN} > 250kHz$)
$\pm 5V$	1MHz 1MHz	$2.5V_{RMS}$ ($f_{IN} > 25kHz$) $0.5V_{RMS}$ ($f_{IN} > 100kHz$)
Single 5V	1MHz 1MHz	$0.7V_{RMS}$ ($f_{IN} > 25kHz$) $0.5V_{RMS}$ ($f_{IN} > 100kHz$)

Table 5. Aliasing ($f_{CLK} = 100kHz$)

INPUT FREQUENCY ($V_{IN} = 1V_{RMS}$) (kHz)	OUTPUT LEVEL (Relative to Input) (dB)	OUTPUT FREQUENCY (Aliased Frequency) (kHz)
$f_{CLK}/f_C = 100:1$, $f_{CUTOFF} = 1kHz$		
96 (or 104)	-75.0	4.0
97 (or 103)	-68.0	3.0
98 (or 102)	-65.0	2.0
98.5 (or 101.5)	-60.0	1.5
99 (or 101)	-3.2	1.0
99.5 (or 100.5)	-0.5	0.5
$f_{CLK}/f_C = 50:1$, $f_{CUTOFF} = 2kHz$		
192 (or 208)	-76.0	8.0
194 (or 206)	-68.0	6.0
196 (or 204)	-63.0	4.0
198 (or 202)	-3.4	2.0
199 (or 201)	-1.3	1.0
199.5 (or 200.5)	-0.9	0.5

Table 6. Transient Response of LTC Lowpass Filters

LOWPASS FILTER	DELAY TIME* (SEC)	RISE TIME** (SEC)	SETTLING TIME*** (SEC)	OVER-SHOOT (%)
LTC1064-3 Bessel	$0.50/f_C$	$0.34/f_C$	$0.80/f_C$	0.5
LTC1164-5 Linear Phase	$0.43/f_C$	$0.34/f_C$	$0.85/f_C$	0
LTC1164-6 Linear Phase	$0.43/f_C$	$0.34/f_C$	$1.15/f_C$	1
LTC1264-7 Linear Phase	$1.15/f_C$	$0.36/f_C$	$2.05/f_C$	5
LTC1164-7 Linear Phase	$1.20/f_C$	$0.39/f_C$	$2.20/f_C$	5
LTC1064-7 Linear Phase	$1.20/f_C$	$0.39/f_C$	$2.20/f_C$	5
LTC1164-5 Butterworth	$0.80/f_C$	$0.48/f_C$	$2.40/f_C$	11
LTC1164-6 Elliptic	$0.85/f_C$	$0.54/f_C$	$4.30/f_C$	18
LTC1064-4 Elliptic	$0.90/f_C$	$0.54/f_C$	$4.50/f_C$	20
LTC1064-1 Elliptic	$0.85/f_C$	$0.54/f_C$	$6.50/f_C$	20

* To 50% $\pm 5\%$, ** 10% to 90% $\pm 5\%$, *** To 1% $\pm 0.5\%$

TYPICAL APPLICATIONS

8th Order Elliptic Lowpass Filter
($f_{CLK}/f_C = 50:1$)

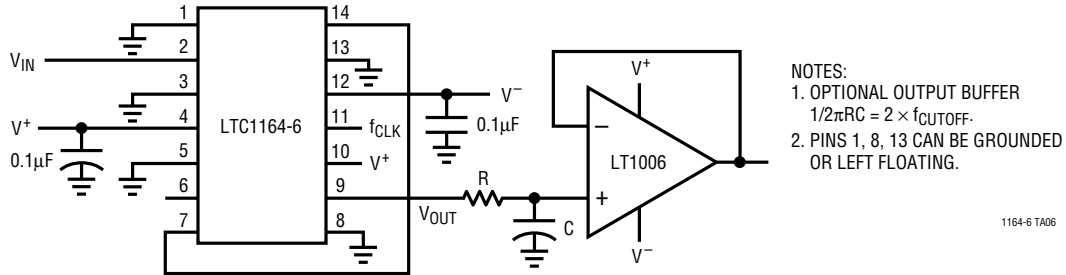

8th Order Elliptic Lowpass Filter
($f_{CLK}/f_C = 100:1$)

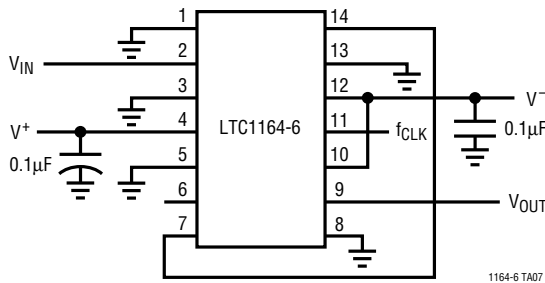

8th Order Linear Phase Lowpass Filter
($f_{CLK}/f_C = 160:1$)

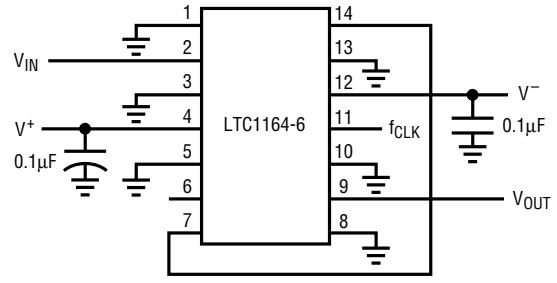

8th Order 20kHz Cutoff, Elliptic Filter Operating with a Single 5V Supply and Driving 1k, 1000pF Load

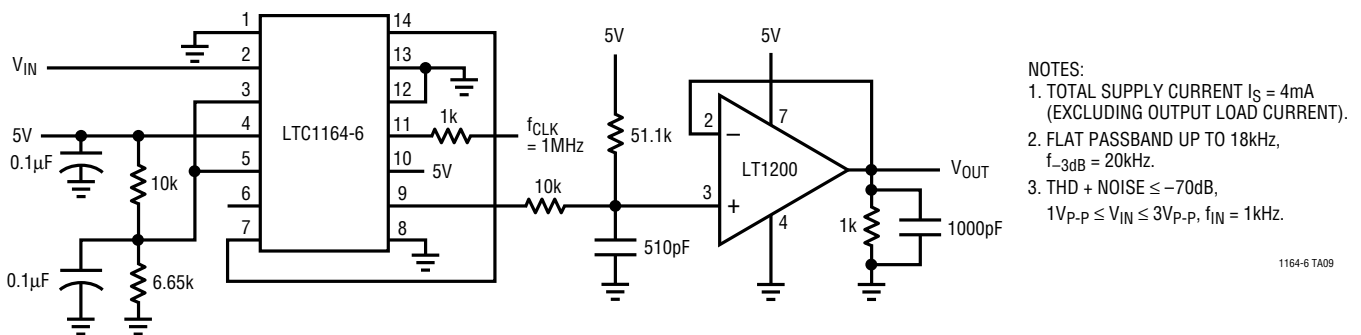

TYPICAL APPLICATIONS

8th Order Low Power, Clock-Tunable Elliptic Filter with Active RC Input Anti-Aliasing Filter and Output Smoothing Filter

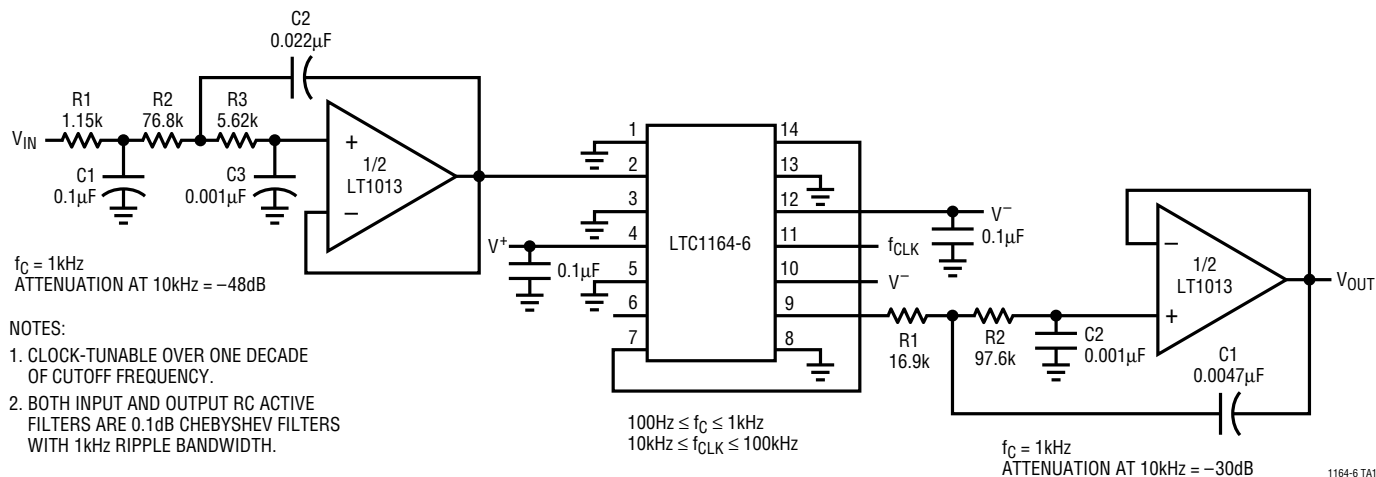

Single 5V, 16th Order Lowpass Filter $f_{CUTOFF} = 10\text{kHz}$

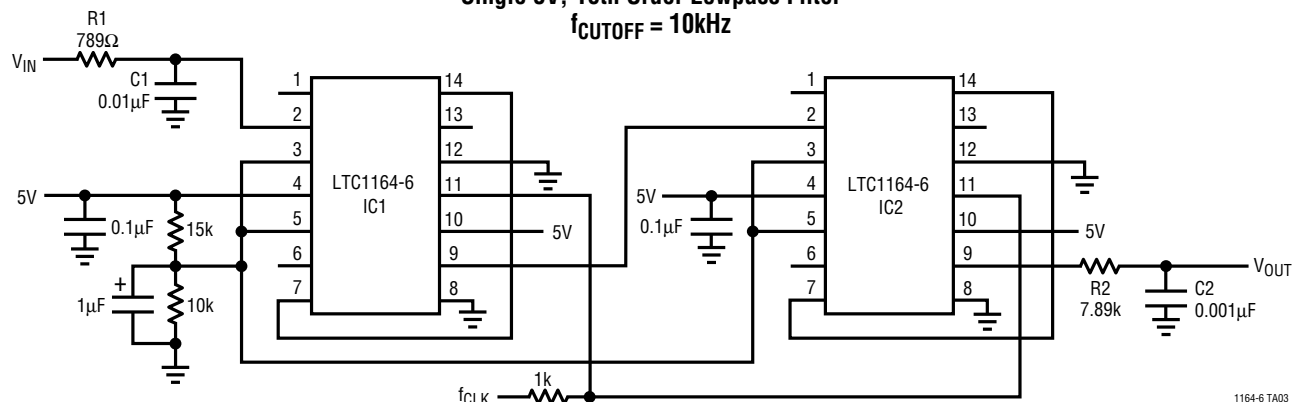

Gain vs Frequency

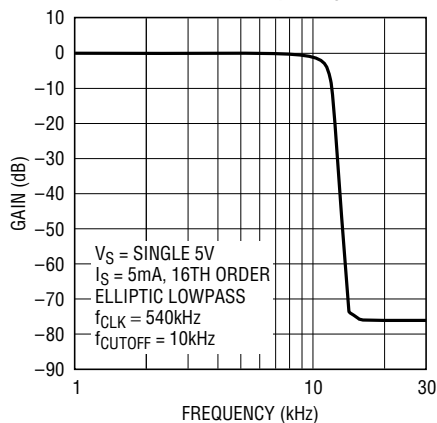

THD + Noise vs Frequency

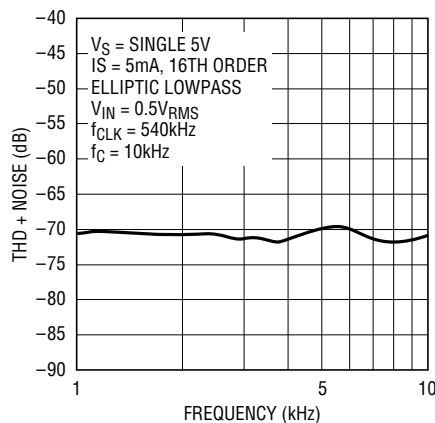

PACKAGE DESCRIPTION Dimensions in inches (millimeters) unless otherwise noted.

**J Package
14-Lead Ceramic DIP**

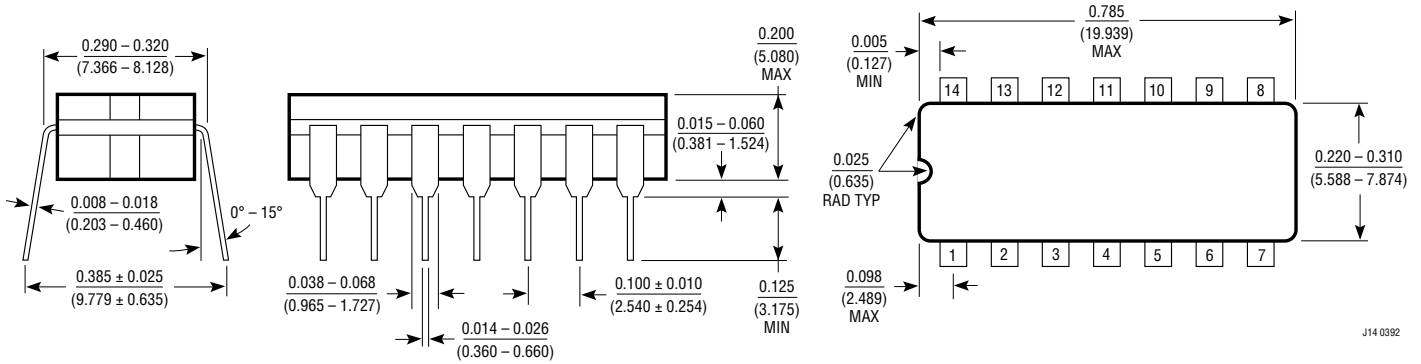

**N Package
14-Lead Plastic DIP**

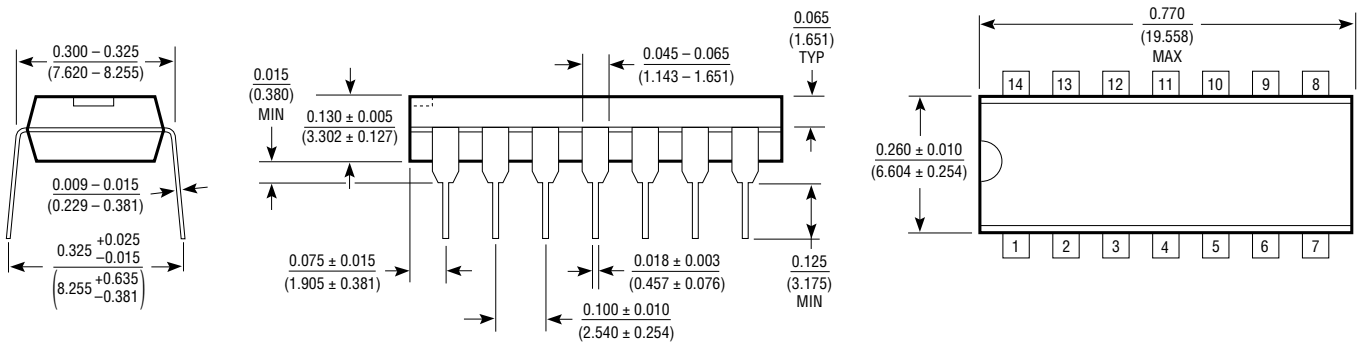

**S Package
16-Lead Plastic SOL**

