

Single/Dual/Quad 400MHz Current Feedback Amplifier

FEATURES

- 400MHz Bandwidth on $\pm 5V$ ($A_V = 1$)
- 350MHz Bandwidth on $\pm 5V$ ($A_V = 2, -1$)
- 0.1dB Gain Flatness: 100MHz ($A_V = 1, 2$ and -1)
- High Slew Rate: 800V/ μ s
- Wide Supply Range: $\pm 2V(4V)$ to $\pm 6V(12V)$
- 80mA Output Current
- Low Supply Current: 4.6mA/Amplifier
- LT1395: SO-8 Package
- LT1396: SO-8 and MSOP Packages
- LT1397: SO-14 and SSOP-16 Packages

DESCRIPTION

The LT[®]1395/LT1396/LT1397 are single/dual/quad 400MHz current feedback amplifiers with an 800V/ μ s slew rate and the ability to drive up to 80mA of output current.

The LT1395/LT1396/LT1397 operate on all supplies from a single 4V to $\pm 6V$. At $\pm 5V$, they draw 4.6mA of supply current per amplifier.

The LT1395/LT1396/LT1397 are manufactured on Linear Technology's proprietary complementary bipolar process. They have standard single/dual/quad pinouts and they are optimized for use on supply voltages of $\pm 5V$.

LT, LTC and LT are registered trademarks of Linear Technology Corporation.

APPLICATIONS

- Cable Drivers
- Video Amplifiers
- MUX Amplifiers
- High Speed Portable Equipment
- IF Amplifiers

TYPICAL APPLICATION

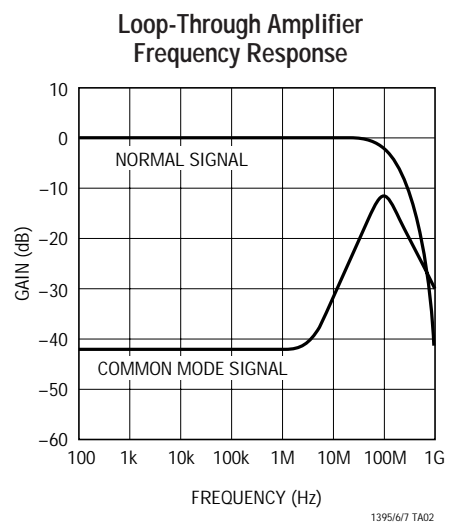
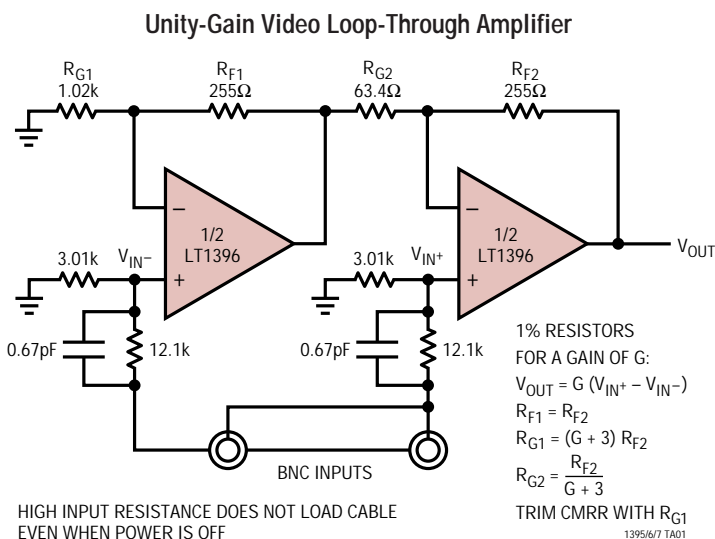

LT1395/LT1396/LT1397

ABSOLUTE MAXIMUM RATINGS (Note 1)

Total Supply Voltage (V^+ to V^-)	12.6V	Operating Temperature Range (Note 4) .	-40°C to 85°C
Input Current (Note 2)	$\pm 10\text{mA}$	Specified Temperature Range (Note 5) ..	-40°C to 85°C
Output Current	$\pm 100\text{mA}$	Storage Temperature Range	-65°C to 150°C
Differential Input Voltage (Note 2)	$\pm 5\text{V}$	Junction Temperature (Note 6)	150°C
Output Short-Circuit Duration (Note 3)	Continuous	Lead Temperature (Soldering, 10 sec)	300°C

PACKAGE/ORDER INFORMATION

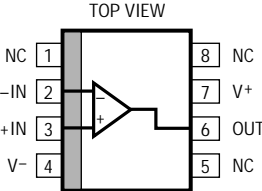
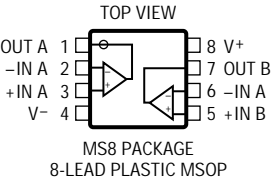
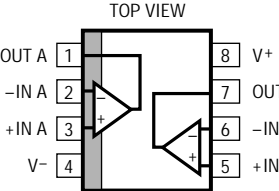
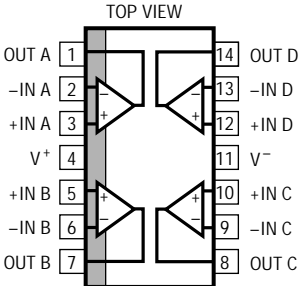
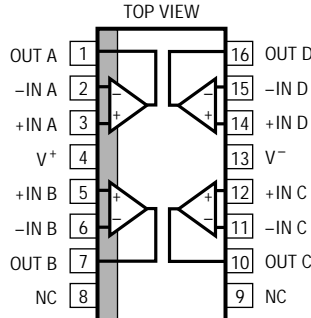
 <p>S8 PACKAGE 8-LEAD PLASTIC SO</p> <p>$T_{JMAX} = 150^{\circ}\text{C}$, $\theta_{JA} = 150^{\circ}\text{C/W}$</p>	 <p>MS8 PACKAGE 8-LEAD PLASTIC MSOP</p> <p>$T_{JMAX} = 150^{\circ}\text{C}$, $\theta_{JA} = 250^{\circ}\text{C/W}$</p>	 <p>S8 PACKAGE 8-LEAD PLASTIC SO</p> <p>$T_{JMAX} = 150^{\circ}\text{C}$, $\theta_{JA} = 150^{\circ}\text{C/W}$</p>
ORDER PART NUMBER	ORDER PART NUMBER	ORDER PART NUMBER
LT1395CS8	LT1396CMS8	LT1396CS8
S8 PART MARKING	MS8 PART MARKING	S8 PART MARKING
1395	LTDY	1396
 <p>S PACKAGE 14-LEAD PLASTIC SO</p> <p>$T_{JMAX} = 150^{\circ}\text{C}$, $\theta_{JA} = 100^{\circ}\text{C/W}$</p>	 <p>GN PACKAGE 16-LEAD PLASTIC SSOP</p> <p>$T_{JMAX} = 150^{\circ}\text{C}$, $\theta_{JA} = 135^{\circ}\text{C/W}$</p>	
ORDER PART NUMBER	ORDER PART NUMBER	
LT1397CS	LT1397CGN	
	GN PART MARKING	
	1397	

Consult factory for Industrial and Military grade parts.

ELECTRICAL CHARACTERISTICS

The ● denotes specifications which apply over the specified operating temperature range, otherwise specifications are at $T_A = 25^\circ\text{C}$. For each amplifier: $V_{CM} = 0\text{V}$, $V_S = \pm 5\text{V}$, pulse tested, unless otherwise noted. (Note 5)

SYMBOL	PARAMETER	CONDITIONS	MIN	TYP	MAX	UNITS
V_{OS}	Input Offset Voltage			1	± 10 ± 12	mV mV
$\Delta V_{OS}/\Delta T$	Input Offset Voltage Drift			15		$\mu\text{V}/^\circ\text{C}$
I_{IN}^+	Noninverting Input Current			10	± 25 ± 30	μA μA
I_{IN}^-	Inverting Input Current			10	± 50 ± 60	μA μA
e_n	Input Noise Voltage Density	$f = 1\text{kHz}$, $R_F = 1\text{k}$, $R_G = 10\Omega$, $R_S = 0\Omega$		4.5		$\text{nV}/\sqrt{\text{Hz}}$
$+i_n$	Noninverting Input Noise Current Density	$f = 1\text{kHz}$		6		$\text{pA}/\sqrt{\text{Hz}}$
$-i_n$	Inverting Input Noise Current Density	$f = 1\text{kHz}$		25		$\text{pA}/\sqrt{\text{Hz}}$
R_{IN}	Input Resistance	$V_{IN} = \pm 3.5\text{V}$	●	0.3	1	M Ω
C_{IN}	Input Capacitance			2.0		pF
V_{INH}	Input Voltage Range, High	$V_S = \pm 5\text{V}$ $V_S = 5\text{V}, 0\text{V}$	●	3.5	4.0 4.0	V V
V_{INL}	Input Voltage Range, Low	$V_S = \pm 5\text{V}$ $V_S = 5\text{V}, 0\text{V}$	●		-4.0 -3.5 1.0	V V V
V_{OUTH}	Output Voltage Swing, High	$V_S = \pm 5\text{V}$ $V_S = \pm 5\text{V}$ $V_S = 5\text{V}, 0\text{V}$	●	3.9 3.7	4.2 4.2	V V V
V_{OUTL}	Output Voltage Swing, Low	$V_S = \pm 5\text{V}$ $V_S = \pm 5\text{V}$ $V_S = 5\text{V}, 0\text{V}$	●		-4.2 -3.9 -3.7 0.8	V V V V
V_{OUTH}	Output Voltage Swing, High	$V_S = \pm 5\text{V}$, $R_L = 150\Omega$ $V_S = \pm 5\text{V}$, $R_L = 150\Omega$ $V_S = 5\text{V}, 0\text{V}$; $R_L = 150\Omega$	●	3.4 3.2	3.6 3.6	V V V
V_{OUTL}	Output Voltage Swing, Low	$V_S = \pm 5\text{V}$, $R_L = 150\Omega$ $V_S = \pm 5\text{V}$, $R_L = 150\Omega$ $V_S = 5\text{V}, 0\text{V}$; $R_L = 150\Omega$	●		-3.6 -3.4 -3.2 0.6	V V V V
CMRR	Common Mode Rejection Ratio	$V_{CM} = \pm 3.5\text{V}$	●	42	52	dB
$-I_{CMRR}$	Inverting Input Current Common Mode Rejection	$V_{CM} = \pm 3.5\text{V}$ $V_{CM} = \pm 3.5\text{V}$	●		10 16 22	$\mu\text{A}/\text{V}$ $\mu\text{A}/\text{V}$ $\mu\text{A}/\text{V}$
PSRR	Power Supply Rejection Ratio	$V_S = \pm 2\text{V}$ to $\pm 5\text{V}$	●	56	70	dB
$+I_{PSRR}$	Noninverting Input Current Power Supply Rejection	$V_S = \pm 2\text{V}$ to $\pm 5\text{V}$	●		1 2 3	$\mu\text{A}/\text{V}$ $\mu\text{A}/\text{V}$ $\mu\text{A}/\text{V}$
$-I_{PSRR}$	Inverting Input Current Power Supply Rejection	$V_S = \pm 2\text{V}$ to $\pm 5\text{V}$	●		2 7	$\mu\text{A}/\text{V}$ $\mu\text{A}/\text{V}$
A_V	Large-Signal Voltage Gain	$V_{OUT} = \pm 2\text{V}$, $R_L = 150\Omega$		50	65	dB
R_{OL}	Transimpedance, $\Delta V_{OUT}/\Delta I_{IN}^-$	$V_{OUT} = \pm 2\text{V}$, $R_L = 150\Omega$		40	100	k Ω
I_{OUT}	Maximum Output Current	$R_L = 0\Omega$	●	80		mA
I_S	Supply Current per Amplifier		●	4.6	6.5	mA
SR	Slew Rate (Note 7)	$A_V = -1$, $R_L = 150\Omega$		500	800	V/ μs
-3dB BW	-3dB Bandwidth	$A_V = 1$, $R_F = 374\Omega$, $R_L = 100\Omega$ $A_V = 2$, $R_F = R_G = 255\Omega$, $R_L = 100\Omega$			400 300	MHz MHz
0.1dB BW	0.1dB Bandwidth	$A_V = 1$, $R_F = 374\Omega$, $R_L = 100\Omega$ $A_V = 2$, $R_F = R_G = 255\Omega$, $R_L = 100\Omega$			100 100	MHz MHz

ELECTRICAL CHARACTERISTICS

The ● denotes specifications which apply over the specified operating temperature range, otherwise specifications are at $T_A = 25^\circ\text{C}$. For each amplifier: $V_{CM} = 0\text{V}$, $V_S = \pm 5\text{V}$, pulse tested, unless otherwise noted. (Note 5)

SYMBOL	PARAMETER	CONDITIONS	MIN	TYP	MAX	UNITS
t_r, t_f	Small-Signal Rise and Fall Time	$R_F = R_G = 255\Omega, R_L = 100\Omega, V_{OUT} = 1\text{V}_{P-P}$		1.3		ns
t_{PD}	Propagation Delay	$R_F = R_G = 255\Omega, R_L = 100\Omega, V_{OUT} = 1\text{V}_{P-P}$		2.5		ns
os	Small-Signal Overshoot	$R_F = R_G = 255\Omega, R_L = 100\Omega, V_{OUT} = 1\text{V}_{P-P}$		10		%
t_S	Settling Time	0.1%, $A_V = -1, R_F = R_G = 280\Omega, R_L = 150\Omega$		25		ns
dG	Differential Gain (Note 8)	$R_F = R_G = 255\Omega, R_L = 150\Omega$		0.02		%
dP	Differential Phase (Note 8)	$R_F = R_G = 255\Omega, R_L = 150\Omega$		0.04		DEG

Note 1: Absolute Maximum Ratings are those values beyond which the life of a device may be impaired.

Note 2: This parameter is guaranteed to meet specified performance through design and characterization. It has not been tested.

Note 3: A heat sink may be required depending on the power supply voltage and how many amplifiers have their outputs short circuited.

Note 4: The LT1395C/LT1396C/LT1397C are guaranteed functional over the operating temperature range of -40°C to 85°C .

Note 5: The LT1395C/LT1396C/LT1397C are guaranteed to meet specified performance from 0°C to 70°C . The LT1395C/LT1396C/LT1397C are designed, characterized and expected to meet specified performance from -40°C and 85°C but is not tested or QA sampled at these temperatures. For guaranteed I-grade parts, consult the factory.

Note 6: T_J is calculated from the ambient temperature T_A and the power dissipation P_D according to the following formula:

$$\text{LT1395CS8: } T_J = T_A + (P_D \cdot 150^\circ\text{C/W})$$

$$\text{LT1396CS8: } T_J = T_A + (P_D \cdot 150^\circ\text{C/W})$$

$$\text{LT1396CMS8: } T_J = T_A + (P_D \cdot 250^\circ\text{C/W})$$

$$\text{LT1397CS14: } T_J = T_A + (P_D \cdot 100^\circ\text{C/W})$$

$$\text{LT1397CGN16: } T_J = T_A + (P_D \cdot 135^\circ\text{C/W})$$

Note 7: Slew rate is measured at $\pm 2\text{V}$ on a $\pm 3\text{V}$ output signal.

Note 8: Differential gain and phase are measured using a Tektronix TSG120YC/NTSC signal generator and a Tektronix 1780R Video Measurement Set. The resolution of this equipment is 0.1% and 0.1°. Ten identical amplifier stages were cascaded giving an effective resolution of 0.01% and 0.01°.

TYPICAL AC PERFORMANCE

V_S (V)	A_V	R_L (Ω)	R_F (Ω)	R_G (Ω)	SMALL SIGNAL -3dB BW (MHz)	SMALL SIGNAL 0.1dB BW (MHz)	SMALL SIGNAL PEAKING (dB)
± 5	1	100	374	-	400	100	0.1
± 5	2	100	255	255	350	100	0.1
± 5	-1	100	280	280	350	100	0.1

TYPICAL PERFORMANCE CHARACTERISTICS

Closed-Loop Gain vs Frequency
($A_V = 1$)

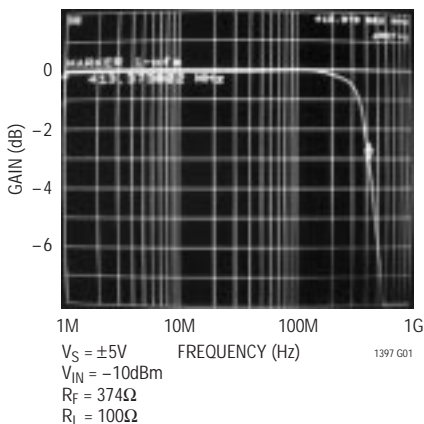

Closed-Loop Gain vs Frequency
($A_V = 2$)

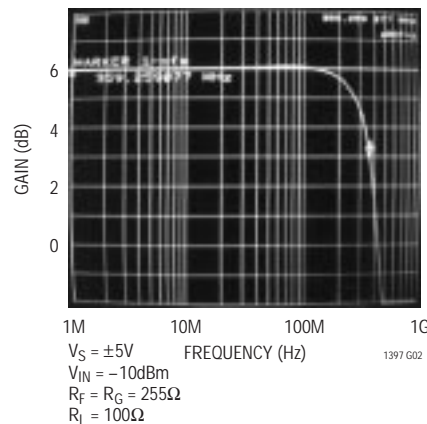

Closed-Loop Gain vs Frequency
($A_V = -1$)

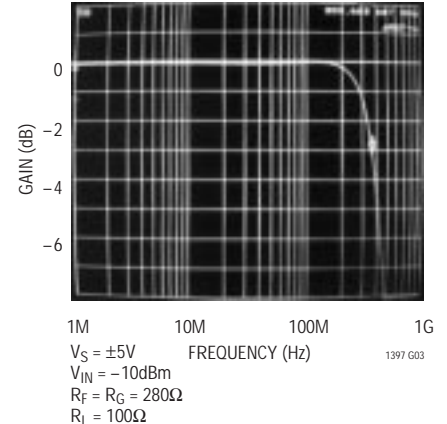

TYPICAL PERFORMANCE CHARACTERISTICS

Large-Signal Transient Response
($A_V = 1$)

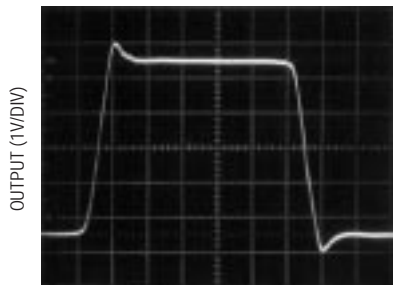

$V_S = \pm 5V$
 $V_{IN} = \pm 2.5V$
 $R_F = 374\Omega$
 $R_L = 100\Omega$
 TIME (10ns/DIV)
 1395/67 G04

Large-Signal Transient Response
($A_V = 2$)



$V_S = \pm 5V$
 $V_{IN} = \pm 1.25V$
 $R_F = R_G = 255\Omega$
 $R_L = 100\Omega$
 TIME (10ns/DIV)
 1395/67 G05

Large-Signal Transient Response
($A_V = -1$)

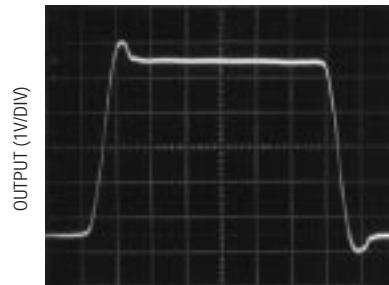

$V_S = \pm 5V$
 $V_{IN} = \pm 2.5V$
 $R_F = R_G = 280\Omega$
 $R_L = 100\Omega$
 TIME (10ns/DIV)
 1395/67 G06

2nd and 3rd Harmonic Distortion vs Frequency

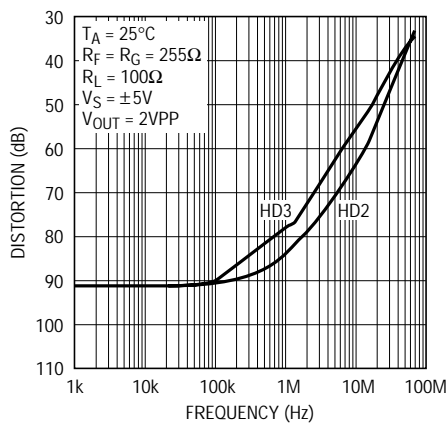

1397 G07

Maximum Undistorted Output Voltage vs Frequency

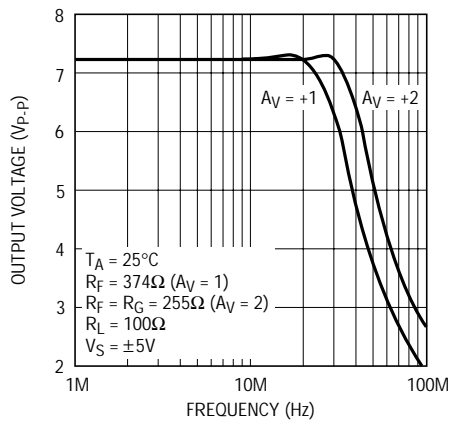

1397 G08

PSRR vs Frequency

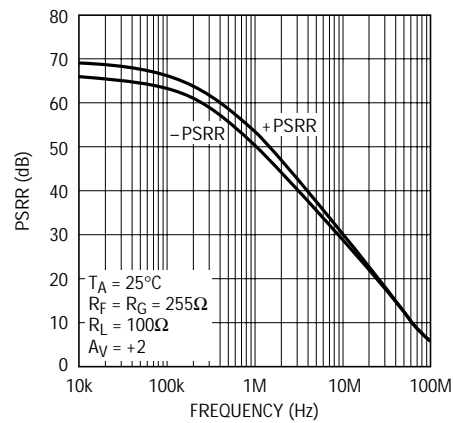

1397 G09

Input Voltage Noise and Current Noise vs Frequency

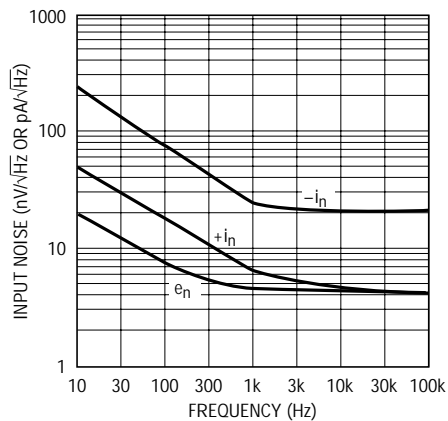

1397 G10

Output Impedance vs Frequency

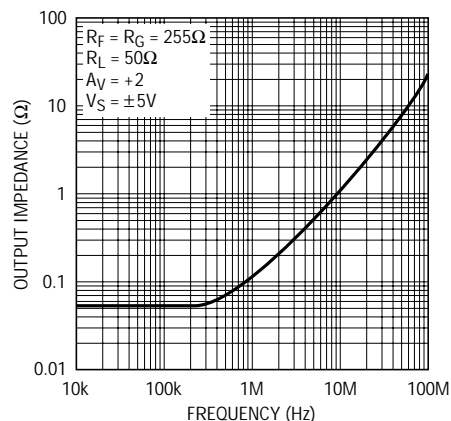

1397 G11

Maximum Capacitive Load vs Feedback Resistor

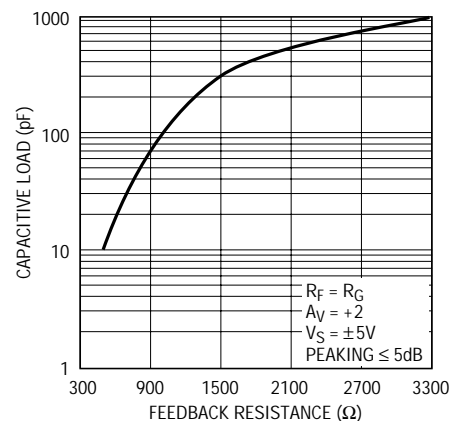

1397 G13

TYPICAL PERFORMANCE CHARACTERISTICS

Capacitive Load vs Output Series Resistor

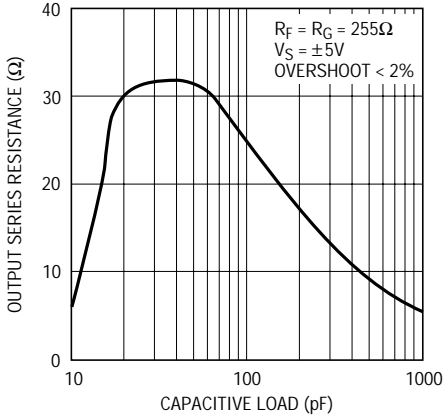

1397 G14

Supply Current vs Supply Voltage

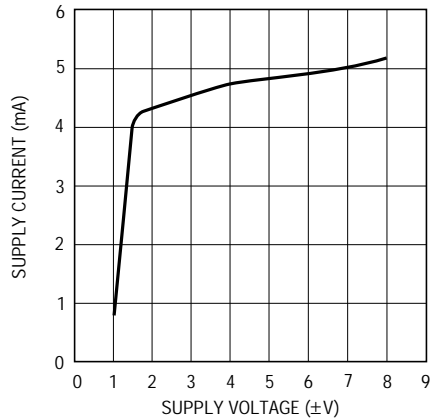

1397 G15

Output Voltage Swing vs Temperature

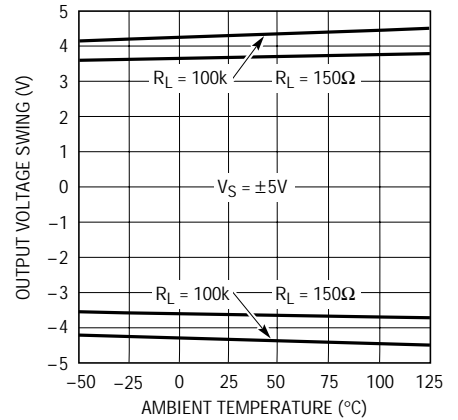

1397 G16

Positive Supply Current per Amplifier vs Temperature

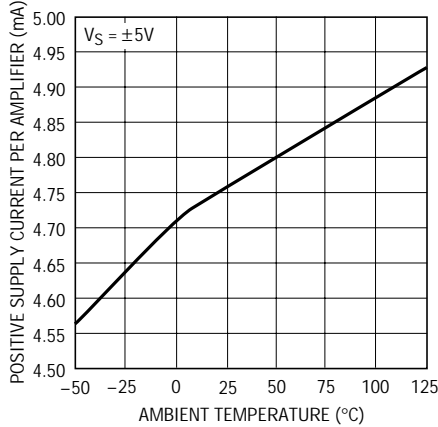

1397 G17

Input Offset Voltage vs Temperature

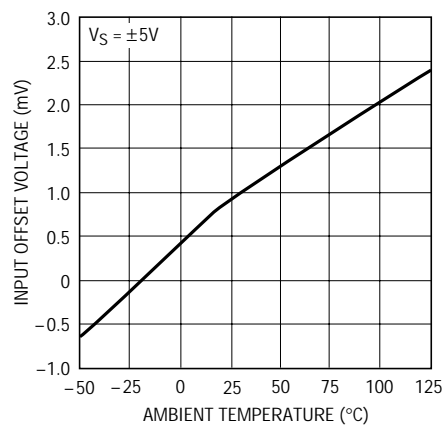

1397 G18

Input Bias Currents vs Temperature

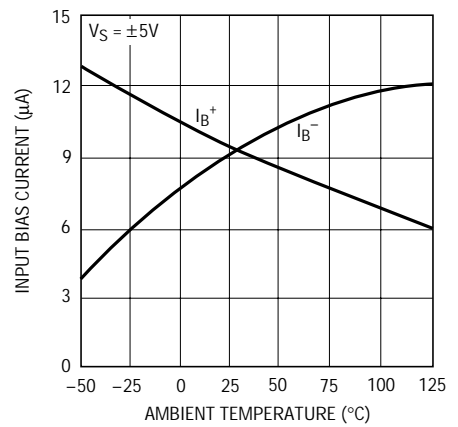

1397 G19

Square Wave Response

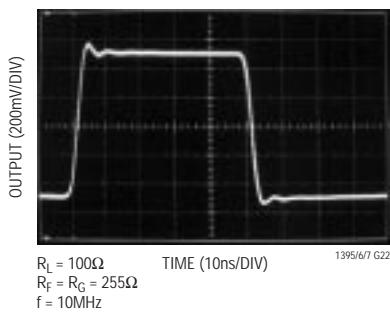

1395/6/7 G22

Propagation Delay

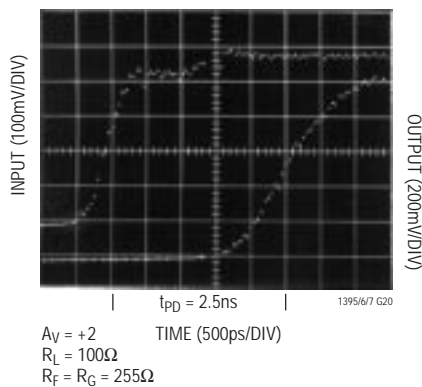

1395/6/7 G20

Rise Time and Overshoot

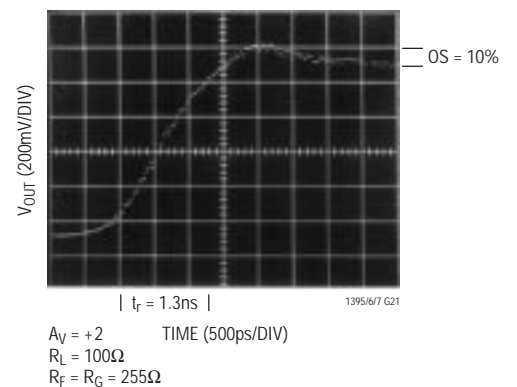

1395/6/7 G21

PIN FUNCTIONS

LT1395CS8

NC (Pin 1): No Connection.

–IN (Pin 2): Inverting Input.

+IN (Pin 3): Noninverting Input.

V⁻ (Pin 4): Negative Supply Voltage, Usually –5V.

NC (Pin 5): No Connection.

OUT (Pin 6): Output.

V⁺ (Pin 7): Positive Supply Voltage, Usually 5V.

NC (Pin 8): No Connection.

LT1396CMS8, LT1396CS8

OUT A (Pin 1): A Channel Output.

–IN A (Pin 2): Inverting Input of A Channel Amplifier.

+IN A (Pin 3): Noninverting Input of A Channel Amplifier.

V⁻ (Pin 4): Negative Supply Voltage, Usually –5V.

+IN B (Pin 5): Noninverting Input of B Channel Amplifier.

–IN B (Pin 6): Inverting Input of B Channel Amplifier.

OUT B (Pin 7): B Channel Output.

V⁺ (Pin 8): Positive Supply Voltage, Usually 5V.

LT1397CS

OUT A (Pin 1): A Channel Output.

–IN A (Pin 2): Inverting Input of A Channel Amplifier.

+IN A (Pin 3): Noninverting Input of A Channel Amplifier.

V⁺ (Pin 4): Positive Supply Voltage, Usually 5V.

+IN B (Pin 5): Noninverting Input of B Channel Amplifier.

–IN B (Pin 6): Inverting Input of B Channel Amplifier.

OUT B (Pin 7): B Channel Output.

OUT C (Pin 8): C Channel Output.

–IN C (Pin 9): Inverting Input of C Channel Amplifier.

+IN C (Pin 10): Noninverting Input of C Channel Amplifier.

V⁻ (Pin 11): Negative Supply Voltage, Usually –5V.

+IN D (Pin 12): Noninverting Input of D Channel Amplifier.

–IN D (Pin 13): Inverting Input of D Channel Amplifier.

OUT D (Pin 14): D Channel Output.

LT1397CGN

OUT A (Pin 1): A Channel Output.

–IN A (Pin 2): Inverting Input of A Channel Amplifier.

+IN A (Pin 3): Noninverting Input of A Channel Amplifier.

V⁺ (Pin 4): Positive Supply Voltage, Usually 5V.

+IN B (Pin 5): Noninverting Input of B Channel Amplifier.

–IN B (Pin 6): Inverting Input of B Channel Amplifier.

OUT B (Pin 7): B Channel Output.

NC (Pin 8): No Connection.

NC (Pin 9): No Connection.

OUT C (Pin 10): C Channel Output.

–IN C (Pin 11): Inverting Input of C Channel Amplifier.

+IN C (Pin 12): Noninverting Input of C Channel Amplifier.

V⁻ (Pin 13): Negative Supply Voltage, Usually –5V.

+IN D (Pin 14): Noninverting Input of D Channel Amplifier.

–IN D (Pin 15): Inverting Input of D Channel Amplifier.

OUT D (Pin 16): D Channel Output.

APPLICATIONS INFORMATION

Feedback Resistor Selection

The small-signal bandwidth of the LT1395/LT1396/LT1397 is set by the external feedback resistors and the internal junction capacitors. As a result, the bandwidth is a function of the supply voltage, the value of the feedback

resistor, the closed-loop gain and the load resistor. The LT1395/LT1396/LT1397 have been optimized for $\pm 5V$ supply operation and have a –3dB bandwidth of 400MHz at a gain of 1 and 350MHz at a gain of 2. Please refer to the resistor selection guide in the Typical AC Performance table.

APPLICATIONS INFORMATION

Capacitance on the Inverting Input

Current feedback amplifiers require resistive feedback from the output to the inverting input for stable operation. Take care to minimize the stray capacitance between the output and the inverting input. Capacitance on the inverting input to ground will cause peaking in the frequency response (and overshoot in the transient response).

Capacitive Loads

The LT1395/LT1396/LT1397 can drive many capacitive loads directly when the proper value of feedback resistor is used. The required value for the feedback resistor will increase as load capacitance increases and as closed-loop gain decreases. Alternatively, a small resistor (5Ω to 35Ω) can be put in series with the output to isolate the capacitive load from the amplifier output. This has the advantage that the amplifier bandwidth is only reduced when the capacitive load is present. The disadvantage is that the gain is a function of the load resistance. See the Typical Performance Characteristics curves.

Power Supplies

The LT1395/LT1396/LT1397 will operate from single or split supplies from $\pm 2V$ (4V total) to $\pm 6V$ (12V total). It is not necessary to use equal value split supplies, however the offset voltage and inverting input bias current will change. The offset voltage changes about 2.5mV per volt of supply mismatch. The inverting bias current will typically change about $10\mu A$ per volt of supply mismatch.

Slew Rate

Unlike a traditional voltage feedback op amp, the slew rate of a current feedback amplifier is not independent of the amplifier gain configuration. In a current feedback amplifier, both the input stage and the output stage have slew rate limitations. In the inverting mode, and for gains of 2 or more in the noninverting mode, the signal amplitude between the input pins is small and the overall slew rate is that of the output stage. For gains less than 2 in the noninverting mode, the overall slew rate is limited by the input stage.

The input slew rate of the LT1395/LT1396/LT1397 is approximately $600V/\mu s$ and is set by internal currents and capacitances. The output slew rate is set by the value of

the feedback resistor and internal capacitance. At a gain of 2 with 255Ω feedback and gain resistors and $\pm 5V$ supplies, the output slew rate is typically $800V/\mu s$. Larger feedback resistors will reduce the slew rate as will lower supply voltages.

Differential Input Signal Swing

To avoid any breakdown condition on the input transistors, the differential input swing must be limited to $\pm 5V$. In normal operation, the differential voltage between the input pins is small, so the $\pm 5V$ limit is not an issue.

Buffered RGB to Color-Difference Matrix

An LT1397 can be used to create buffered color-difference signals from RGB inputs (Figure 1). In this application, the R input arrives via 75Ω coax. It is routed to the noninverting input of LT1397 amplifier A1 and to a 845Ω resistor R8. There is also an 82.5Ω termination resistor R11, which yields a 75Ω input impedance at the R input when considered in parallel with R8. R8 connects to the inverting input of a second LT1397 amplifier (A2), which also sums the weighted G and B inputs to create a $-0.5 \cdot Y$ output. LT1397 amplifier A3 then takes the $-0.5 \cdot Y$ output and amplifies it by a gain of -2 , resulting in the Y output. Amplifier A1 is configured in a noninverting gain of 2 with the bottom of the gain resistor R2 tied to the Y output. The output of amplifier A1 thus results in the color-difference output R-Y.

The B input is similar to the R input. It arrives via 75Ω coax, and is routed to the noninverting input of LT1397 amplifier A4, and to a 2320Ω resistor R10. There is also a 76.8Ω termination resistor R13, which yields a 75Ω input impedance when considered in parallel with R10. R10 also connects to the inverting input of amplifier A2, adding the B contribution to the Y signal as discussed above. Amplifier A4 is configured in a noninverting gain of 2 configuration with the bottom of the gain resistor R4 tied to the Y output. The output of amplifier A4 thus results in the color-difference output B-Y.

The G input also arrives via 75Ω coax and adds its contribution to the Y signal via a 432Ω resistor R9, which is tied to the inverting input of amplifier A2. There is also a 90.9Ω termination resistor R12, which yields a 75Ω

APPLICATIONS INFORMATION

termination when considered in parallel with R9. Using superposition, it is straightforward to determine the output of amplifier A2. Although inverted, it sums the R, G and B signals in the standard proportions of 0.3R, 0.59G and 0.11B that are used to create the Y signal. Amplifier A3 then inverts and amplifies the signal by 2, resulting in the Y output.

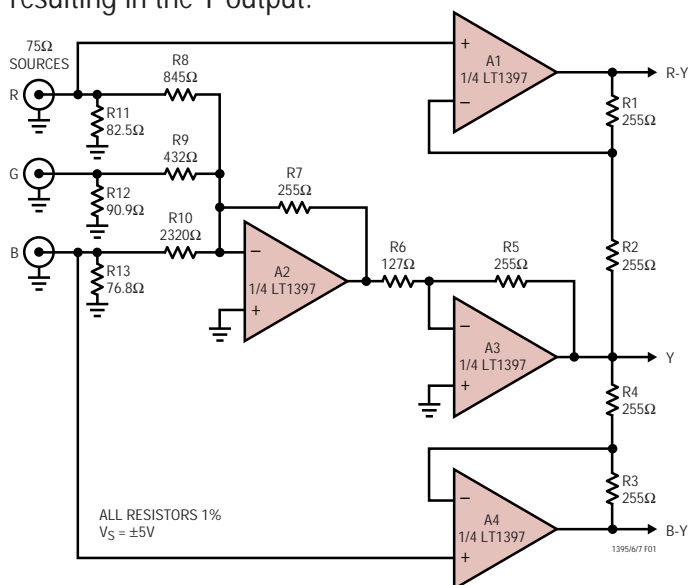

Figure 1. Buffered RGB to Color-Difference Matrix

Buffered Color-Difference to RGB Matrix

An LT1395 combined with an LT1396 can be used to create buffered RGB outputs from color-difference signals (Figure 2). The R output is a back-terminated 75Ω signal created using resistor R5 and amplifier A1 configured for a gain of +2 via 255Ω resistors R3 and R4. The noninverting input of amplifier A1 is connected via 1k resistors R1 and R2 to the Y and R-Y inputs respectively, resulting in cancellation of the Y signal at the amplifier input. The remaining R signal is then amplified by A1.

The B output is also a back-terminated 75Ω signal created using resistor R16 and amplifier A3 configured for a gain of +2 via 255Ω resistors R14 and R15. The noninverting input of amplifier A3 is connected via 1k resistors R12 and R13 to the Y and B-Y inputs respectively, resulting in cancellation of the Y signal at the amplifier input. The remaining B signal is then amplified by A3.

The G output is the most complicated of the three. It is a weighted sum of the Y, R-Y and B-Y inputs. The Y input

is attenuated via resistors R6 and R7 such that amplifier A2's noninverting input sees 0.83Y. Using superposition, we can calculate the positive gain of A2 by assuming that R8 and R9 are grounded. This results in a gain of 2.41 and a contribution at the output of A2 of 2Y. The R-Y input is amplified by A2 with the gain set by resistors R8 and R10, giving an amplification of -1.02. This results in a contribution at the output of A2 of 1.02Y - 1.02R. The B-Y input is amplified by A2 with the gain set by resistors R9 and R10, giving an amplification of -0.37. This results in a contribution at the output of A2 of 0.37Y - 0.37B.

If we now sum the three contributions at the output of A2, we get:

$$A2_{OUT} = 3.40Y - 1.02R - 0.37B$$

It is important to remember though that Y is a weighted sum of R, G and B such that:

$$Y = 0.3R + 0.59G + 0.11B$$

If we substitute for Y at the output of A2 we then get:

$$A2_{OUT} = (1.02R - 1.02R) + 2G + (0.37B - 0.37B) = 2G$$

The back-termination resistor R11 then halves the output of A2 resulting in the G output.

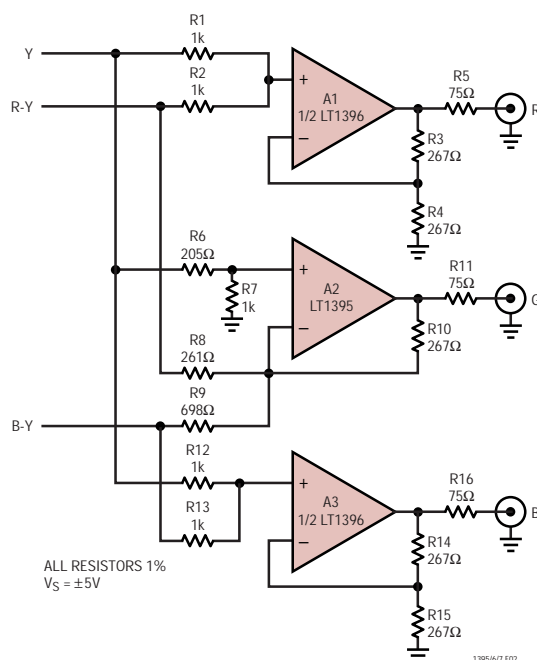
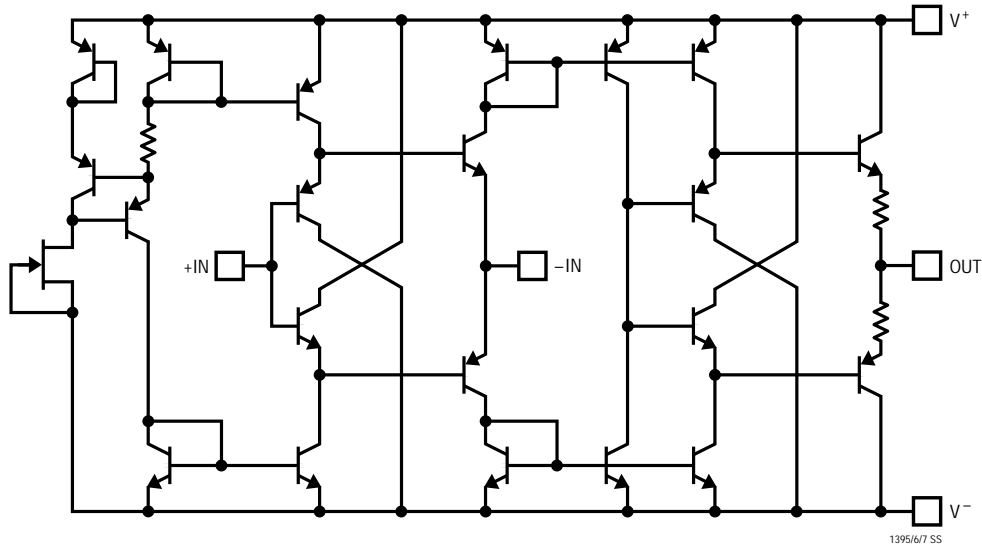

Figure 2. Buffered Color-Difference to RGB Matrix

SIMPLIFIED SCHEMATIC, each amplifier



PACKAGE DESCRIPTION Dimensions in inches (millimeters) unless otherwise noted.

GN Package
16-Lead Plastic SSOP (Narrow 0.150)
(LTC DWG # 05-08-1641)

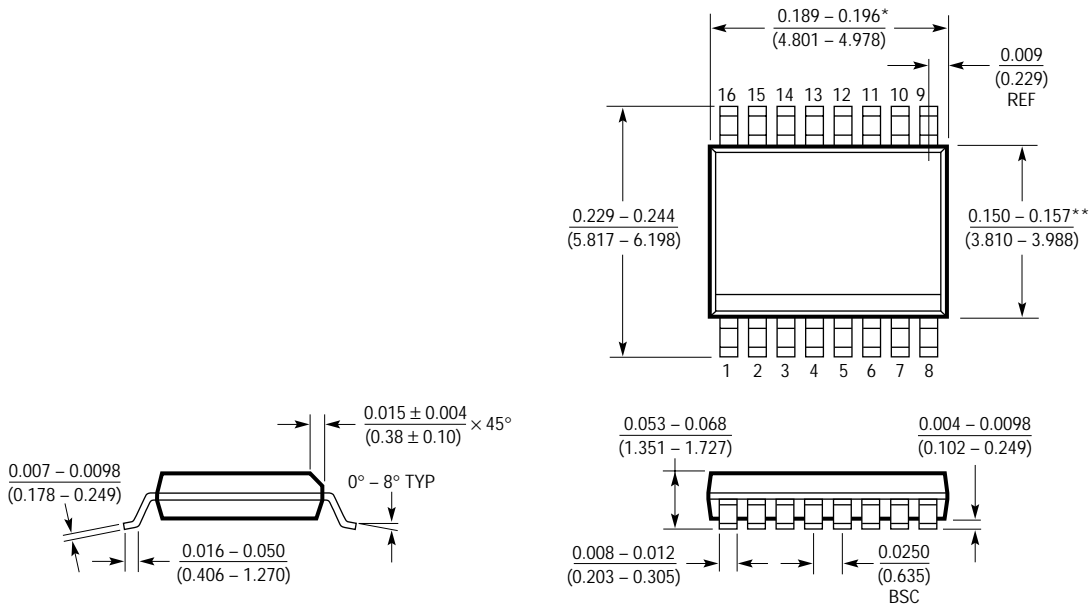

* DIMENSION DOES NOT INCLUDE MOLD FLASH. MOLD FLASH SHALL NOT EXCEED 0.006* (0.152mm) PER SIDE
** DIMENSION DOES NOT INCLUDE INTERLEAD FLASH. INTERLEAD FLASH SHALL NOT EXCEED 0.010* (0.254mm) PER SIDE

GN16 (SSOP) 1098

PACKAGE DESCRIPTION

Dimensions in inches (millimeters) unless otherwise noted.

MS8 Package 8-Lead Plastic MSOP (LTC DWG # 05-08-1660)

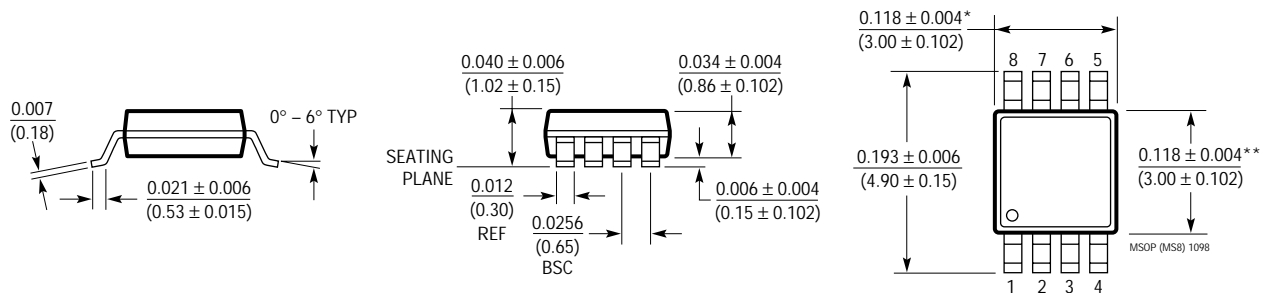

* DIMENSION DOES NOT INCLUDE MOLD FLASH, PROTRUSIONS OR GATE BURRS. MOLD FLASH, PROTRUSIONS OR GATE BURRS SHALL NOT EXCEED 0.006* (0.152mm) PER SIDE

** DIMENSION DOES NOT INCLUDE INTERLEAD FLASH OR PROTRUSIONS. INTERLEAD FLASH OR PROTRUSIONS SHALL NOT EXCEED 0.006* (0.152mm) PER SIDE

S8 Package 8-Lead Plastic Small Outline (Narrow 0.150) (LTC DWG # 05-08-1610)

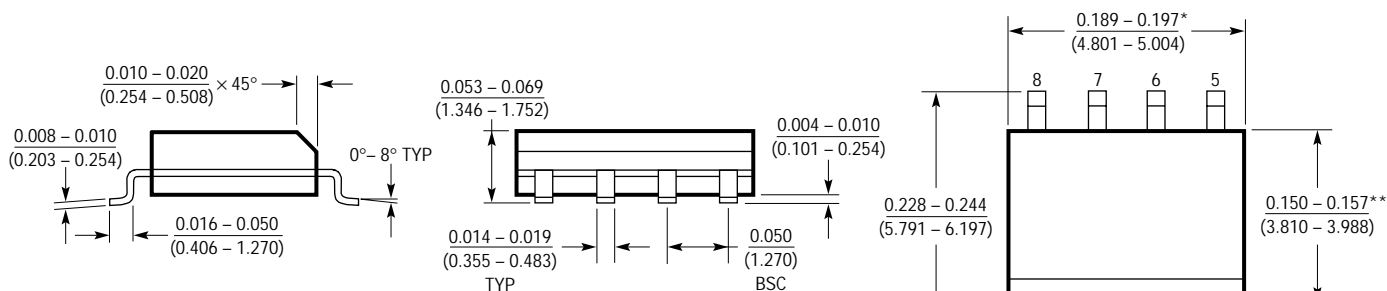

DIMENSION DOES NOT INCLUDE MOLD FLASH. MOLD FLASH SHALL NOT EXCEED 0.006 (0.152mm) PER SIDE

**DIMENSION DOES NOT INCLUDE INTERLEAD FLASH. INTERLEAD FLASH SHALL NOT EXCEED 0.010* (0.254mm) PER SIDE

S Package 14-Lead Plastic Small Outline (Narrow 0.150) (LTC DWG # 05-08-1610)

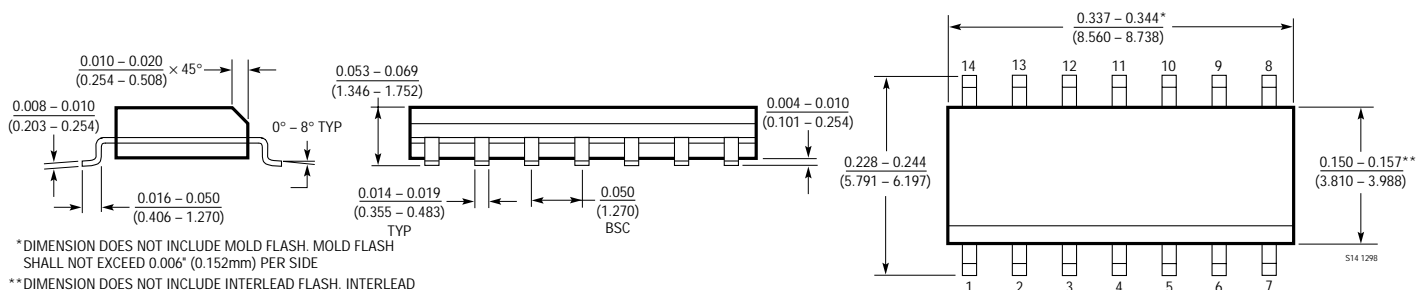

DIMENSION DOES NOT INCLUDE MOLD FLASH. MOLD FLASH SHALL NOT EXCEED 0.006 (0.152mm) PER SIDE

**DIMENSION DOES NOT INCLUDE INTERLEAD FLASH. INTERLEAD FLASH SHALL NOT EXCEED 0.010* (0.254mm) PER SIDE

TYPICAL APPLICATION

Single Supply RGB Video Amplifier

The LT1395 can be used with a single supply voltage of 6V or more to drive ground-referenced RGB video. In Figure 3, two 1N4148 diodes D1 and D2 have been placed in series with the output of the LT1395 amplifier A1 but within the feedback loop formed by resistor R8. These diodes effectively level-shift A1's output downward by 2 diodes, allowing the circuit output to swing to ground.

Amplifier A1 is used in a positive gain configuration. The feedback resistor R8 is 255Ω. The gain resistor is created from the parallel combination of R6 and R7, giving a Thevenin equivalent 63.5Ω connected to 3.75V. This gives an AC gain of +5 from the noninverting input of amplifier A1 to the cathode of D2. However, the video input is also attenuated before arriving at A1's positive

input. Assuming a 75Ω source impedance for the signal driving V_{IN} , the Thevenin equivalent signal arriving at A1's positive input is $3V + 0.4V_{IN}$, with a source impedance of 714Ω. The combination of these two inputs gives an output at the cathode of D2 of $2 \cdot V_{IN}$ with no additional DC offset. The 75Ω back termination resistor R9 halves the signal again such that V_{OUT} equals a buffered version of V_{IN} .

It is important to note that the 4.7μF capacitor C1 has been added to provide enough current to maintain the voltage drop across diodes D1 and D2 when the circuit output drops low enough that the diodes might otherwise turn off. This means that this circuit works fine for continuous video input, but will require that C1 charge up after a period of inactivity at the input.

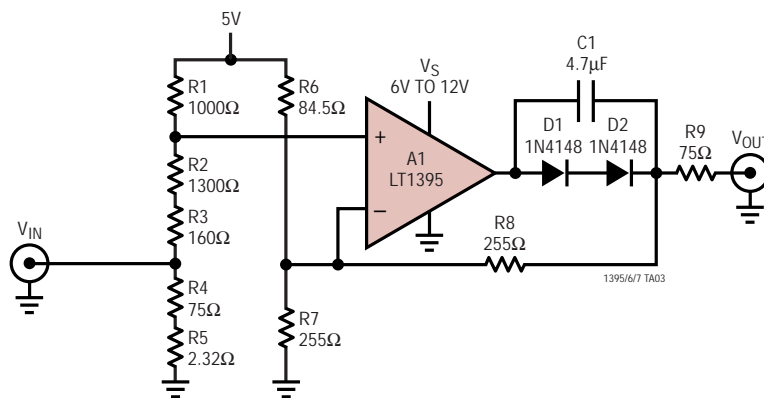

Figure 3. Single Supply RGB Video Amplifier (1 of 4 Channels)

RELATED PARTS

PART NUMBER	DESCRIPTION	COMMENTS
LT1227/LT1229/LT1230	140MHz Single/Dual/Quad Current Feedback Amplifier	1100V/μs Slew Rate, Single Adds Shutdown Pin
LT1252/LT1253/LT1254	Low Cost Video Amplifiers	Single, Dual and Quad 100MHz Current Feedback Amplifiers
LT1398/LT1399	Dual/Triple Current Feedback Amplifiers	300MHz Bandwidth, 0.1dB Flatness > 150MHz with Shutdown
LT1675	Triple 2:1 Buffered Video Multiplexer	2.5ns Switching Time, 250MHz Bandwidth
LT1363/LT1364/LT1365	70MHz Single/Dual/Quad Op Amps	1000V/μs Slew Rate, Voltage Feedback