

## FEATURES

- 25MHz Gain Bandwidth
- 600V/ $\mu$ s Slew Rate
- 2.5mA Maximum Supply Current
- Unity-Gain Stable
- C-Load™ Op Amp Drives All Capacitive Loads
- 8nV/ $\sqrt{\text{Hz}}$  Input Noise Voltage
- 600 $\mu$ V Maximum Input Offset Voltage
- 500nA Maximum Input Bias Current
- 120nA Maximum Input Offset Current
- 20V/mV Minimum DC Gain,  $R_L=1k$
- 115ns Settling Time to 0.1%, 10V Step
- 220ns Settling Time to 0.01%, 10V Step
- $\pm 12\text{V}$  Minimum Output Swing into 500 $\Omega$
- $\pm 2.5\text{V}$  Minimum Output Swing into 150 $\Omega$
- Specified at  $\pm 2.5\text{V}$ ,  $\pm 5\text{V}$ , and  $\pm 15\text{V}$

## APPLICATIONS

- Wideband Amplifiers
- Buffers
- Active Filters
- Data Acquisition Systems
- Photodiode Amplifiers

LT, LTC and LT are registered trademarks of Linear Technology Corporation.  
 C-Load is a trademark of Linear Technology Corporation

## DESCRIPTION

The LT<sup>®</sup>1357 is a high speed, very high slew rate operational amplifier with outstanding AC and DC performance. The LT1357 has much lower supply current, lower input offset voltage, lower input bias current, and higher DC gain than devices with comparable bandwidth. The circuit topology is a voltage feedback amplifier with the slewing characteristics of a current feedback amplifier. The amplifier is a single gain stage with outstanding settling characteristics which makes the circuit an ideal choice for data acquisition systems. The output drives a 500 $\Omega$  load to  $\pm 12\text{V}$  with  $\pm 15\text{V}$  supplies and a 150 $\Omega$  load to  $\pm 2.5\text{V}$  on  $\pm 5\text{V}$  supplies. The amplifier is also stable with any capacitive load which makes it useful in buffer or cable driver applications.

The LT1357 is a member of a family of fast, high performance amplifiers using this unique topology and employing Linear Technology Corporation's advanced bipolar complementary processing. For dual and quad amplifier versions of the LT1357 see the LT1358/LT1359 data sheet. For higher bandwidth devices with higher supply current see the LT1360 through LT1365 data sheets. For lower supply current amplifiers see the LT1354 and LT1355/LT1356 data sheets. Singles, duals, and quads of each amplifier are available.

## TYPICAL APPLICATION

DAC I-to-V Converter

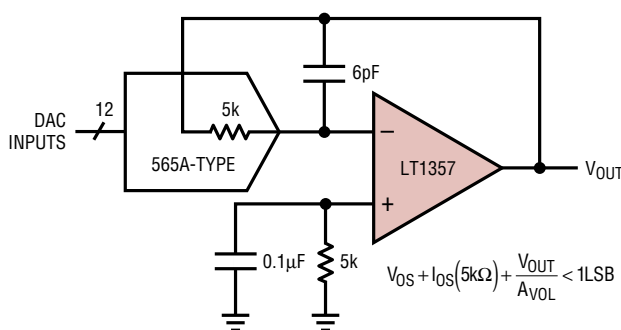

$A_V = -1$  Large-Signal Response

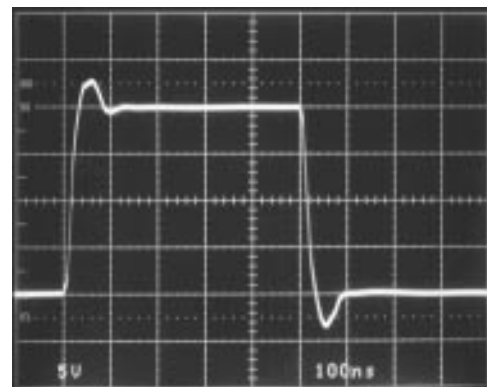

1357 TA02

## ABSOLUTE MAXIMUM RATINGS

Total Supply Voltage ( $V^+$ to $V^-$ ) .....	36V	Specified Temperature Range (Note 6) ...	$-40^{\circ}\text{C}$ to $85^{\circ}\text{C}$
Differential Input Voltage (Transient Only, Note 1) ...	$\pm 10\text{V}$	Maximum Junction Temperature (See Below)	
Input Voltage .....	$\pm V_S$	Plastic Package .....	$150^{\circ}\text{C}$
Output Short-Circuit Duration (Note 2) .....	Indefinite	Storage Temperature Range .....	$-65^{\circ}\text{C}$ to $150^{\circ}\text{C}$
Operating Temperature Range .....	$-40^{\circ}\text{C}$ to $85^{\circ}\text{C}$	Lead Temperature (Soldering, 10 sec) .....	$300^{\circ}\text{C}$

## PACKAGE/ORDER INFORMATION

<p>TOP VIEW</p> <p>NULL 1 8 NULL</p> <p>-IN 2 7 V+</p> <p>+IN 3 6 VOUT</p> <p>V- 4 5 NC</p> <p>N8 PACKAGE, 8-LEAD PLASTIC DIP</p> <p><math>T_{JMAX} = 150^{\circ}\text{C}</math>, <math>\theta_{JA} = 130^{\circ}\text{C/W}</math></p>	ORDER PART NUMBER	<p>TOP VIEW</p> <p>NULL 1 8 NULL</p> <p>-IN 2 7 V+</p> <p>+IN 3 6 VOUT</p> <p>V- 4 5 NC</p> <p>S8 PACKAGE, 8-LEAD PLASTIC SOIC</p> <p><math>T_{JMAX} = 150^{\circ}\text{C}</math>, <math>\theta_{JA} = 190^{\circ}\text{C/W}</math></p>	ORDER PART NUMBER
	LT1357CN8		LT1357CS8
			S8 PART MARKING
			1357

Consult factory for Industrial and Military grade parts.

## ELECTRICAL CHARACTERISTICS $T_A = 25^{\circ}\text{C}$ , $V_{CM} = 0\text{V}$ unless otherwise noted.

SYMBOL	PARAMETER	CONDITIONS	$V_{SUPPLY}$	MIN	TYP	MAX	UNITS
$V_{OS}$	Input Offset Voltage		$\pm 15\text{V}$	0.2	0.6		mV
			$\pm 5\text{V}$	0.2	0.6		mV
			$\pm 2.5\text{V}$	0.3	0.8		mV
$I_{OS}$	Input Offset Current		$\pm 2.5\text{V}$ to $\pm 15\text{V}$	40	120		nA
$I_B$	Input Bias Current		$\pm 2.5\text{V}$ to $\pm 15\text{V}$	120	500		nA
$e_n$	Input Noise Voltage	$f = 10\text{kHz}$	$\pm 2.5\text{V}$ to $\pm 15\text{V}$	8			$\text{nV}/\sqrt{\text{Hz}}$
$i_n$	Input Noise Current	$f = 10\text{kHz}$	$\pm 2.5\text{V}$ to $\pm 15\text{V}$	0.8			$\text{pA}/\sqrt{\text{Hz}}$
$R_{IN}$	Input Resistance	$V_{CM} = \pm 12\text{V}$ Differential	$\pm 15\text{V}$	35	80		$\text{M}\Omega$
			$\pm 15\text{V}$		6		$\text{M}\Omega$
$C_{IN}$	Input Capacitance		$\pm 15\text{V}$	3			pF
	Input Voltage Range <sup>+</sup>		$\pm 15\text{V}$	12.0	13.4		V
			$\pm 5\text{V}$	2.5	3.5		V
			$\pm 2.5\text{V}$	0.5	1.1		V
	Input Voltage Range <sup>-</sup>		$\pm 15\text{V}$	-13.2	-12.0		V
			$\pm 5\text{V}$	-3.3	-2.5		V
			$\pm 2.5\text{V}$	-0.9	-0.5		V
CMRR	Common Mode Rejection Ratio	$V_{CM} = \pm 12\text{V}$	$\pm 15\text{V}$	80	97		dB
		$V_{CM} = \pm 2.5\text{V}$	$\pm 5\text{V}$	78	84		dB
		$V_{CM} = \pm 0.5\text{V}$	$\pm 2.5\text{V}$	68	75		dB
PSRR	Power Supply Rejection Ratio	$V_S = \pm 2.5\text{V}$ to $\pm 15\text{V}$		92	106		dB
$A_{VOL}$	Large-Signal Voltage Gain	$V_{OUT} = \pm 12\text{V}$ , $R_L = 1\text{k}$	$\pm 15\text{V}$	20.0	65		V/mV
		$V_{OUT} = \pm 10\text{V}$ , $R_L = 500\Omega$	$\pm 15\text{V}$	7.0	25		V/mV
		$V_{OUT} = \pm 2.5\text{V}$ , $R_L = 1\text{k}$	$\pm 5\text{V}$	20.0	45		V/mV
		$V_{OUT} = \pm 2.5\text{V}$ , $R_L = 500\Omega$	$\pm 5\text{V}$	7.0	25		V/mV
		$V_{OUT} = \pm 2.5\text{V}$ , $R_L = 150\Omega$	$\pm 5\text{V}$	1.5	6		V/mV
		$V_{OUT} = \pm 1\text{V}$ , $R_L = 500\Omega$	$\pm 2.5\text{V}$	7.0	30		V/mV

**ELECTRICAL CHARACTERISTICS**  $T_A = 25^\circ\text{C}$ ,  $V_{CM} = 0\text{V}$  unless otherwise noted.

SYMBOL	PARAMETER	CONDITIONS	$V_{SUPPLY}$	MIN	TYP	MAX	UNITS
$V_{OUT}$	Output Swing	$R_L = 1\text{k}$ , $V_{IN} = \pm 40\text{mV}$	$\pm 15\text{V}$	13.3	13.8		$\pm\text{V}$
		$R_L = 500\Omega$ , $V_{IN} = \pm 40\text{mV}$	$\pm 15\text{V}$	12.0	12.8		$\pm\text{V}$
		$R_L = 500\Omega$ , $V_{IN} = \pm 40\text{mV}$	$\pm 5\text{V}$	3.5	4.0		$\pm\text{V}$
		$R_L = 150\Omega$ , $V_{IN} = \pm 40\text{mV}$	$\pm 5\text{V}$	2.5	3.3		$\pm\text{V}$
		$R_L = 500\Omega$ , $V_{IN} = \pm 40\text{mV}$	$\pm 2.5\text{V}$	1.3	1.7		$\pm\text{V}$
$I_{OUT}$	Output Current	$V_{OUT} = \pm 12\text{V}$	$\pm 15\text{V}$	24.0	30		mA
		$V_{OUT} = \pm 2.5\text{V}$	$\pm 5\text{V}$	16.7	25		mA
$I_{SC}$	Short-Circuit Current	$V_{OUT} = 0\text{V}$ , $V_{IN} = \pm 3\text{V}$	$\pm 15\text{V}$	30	42		mA
SR	Slew Rate	$A_V = -2$ , (Note 3)	$\pm 15\text{V}$	300	600		V/ $\mu\text{s}$
			$\pm 5\text{V}$	150	220		V/ $\mu\text{s}$
	Full Power Bandwidth	10V Peak, (Note 4) 3V Peak, (Note 4)	$\pm 15\text{V}$		9.6		MHz
			$\pm 5\text{V}$		11.7		MHz
GBW	Gain Bandwidth	$f = 200\text{kHz}$ , $R_L = 2\text{k}$	$\pm 15\text{V}$	18	25		MHz
			$\pm 5\text{V}$	15	22		MHz
			$\pm 2.5\text{V}$		20		MHz
$t_r$ , $t_f$	Rise Time, Fall Time	$A_V = 1$ , 10%-90%, 0.1V	$\pm 15\text{V}$		8		ns
			$\pm 5\text{V}$		9		ns
	Overshoot	$A_V = 1$ , 0.1V	$\pm 15\text{V}$		27		%
			$\pm 5\text{V}$		27		%
	Propagation Delay	50% $V_{IN}$ to 50% $V_{OUT}$ , 0.1V	$\pm 15\text{V}$		9		ns
			$\pm 5\text{V}$		11		ns
$t_s$	Settling Time	10V Step, 0.1%, $A_V = -1$ 10V Step, 0.01%, $A_V = -1$ 5V Step, 0.1%, $A_V = -1$ 5V Step, 0.01%, $A_V = -1$	$\pm 15\text{V}$		115		ns
			$\pm 15\text{V}$		220		ns
			$\pm 5\text{V}$		110		ns
			$\pm 5\text{V}$		380		ns
	Differential Gain	$f = 3.58\text{MHz}$ , $A_V = 2$ , $R_L = 1\text{k}$	$\pm 15\text{V}$		0.1		%
			$\pm 5\text{V}$		0.1		%
	Differential Phase	$f = 3.58\text{MHz}$ , $A_V = 2$ , $R_L = 1\text{k}$	$\pm 15\text{V}$		0.50		Deg
			$\pm 5\text{V}$		0.35		Deg
$R_O$	Output Resistance	$A_V = 1$ , $f = 100\text{kHz}$	$\pm 15\text{V}$		0.3		$\Omega$
$I_S$	Supply Current		$\pm 15\text{V}$		2.0	2.5	mA
			$\pm 5\text{V}$		1.9	2.4	mA

 $0^\circ\text{C} \leq T_A \leq 70^\circ\text{C}$ ,  $V_{CM} = 0\text{V}$  unless otherwise noted.

SYMBOL	PARAMETER	CONDITIONS	$V_{SUPPLY}$	MIN	TYP	MAX	UNITS	
$V_{OS}$	Input Offset Voltage		$\pm 15\text{V}$	●		0.8	mV	
			$\pm 5\text{V}$	●		0.8	mV	
			$\pm 2.5\text{V}$	●		1.0	mV	
	Input $V_{OS}$ Drift	(Note 5)	$\pm 2.5\text{V}$ to $\pm 15\text{V}$	●	5	8	$\mu\text{V}/^\circ\text{C}$	
$I_{OS}$	Input Offset Current		$\pm 2.5\text{V}$ to $\pm 15\text{V}$	●		180	nA	
$I_B$	Input Bias Current		$\pm 2.5\text{V}$ to $\pm 15\text{V}$	●		750	nA	
CMRR	Common Mode Rejection Ratio	$V_{CM} = \pm 12\text{V}$ $V_{CM} = \pm 2.5\text{V}$ $V_{CM} = \pm 0.5\text{V}$	$\pm 15\text{V}$	●	79		dB	
			$\pm 5\text{V}$	●	77		dB	
			$\pm 2.5\text{V}$	●	67		dB	
PSRR	Power Supply Rejection Ratio	$V_S = \pm 2.5\text{V}$ to $\pm 15\text{V}$		●	90		dB	
$A_{VOL}$	Large-Signal Voltage Gain	$V_{OUT} = \pm 12\text{V}$ , $R_L = 1\text{k}$ $V_{OUT} = \pm 10\text{V}$ , $R_L = 500\Omega$ $V_{OUT} = \pm 2.5\text{V}$ , $R_L = 1\text{k}$ $V_{OUT} = \pm 2.5\text{V}$ , $R_L = 500\Omega$ $V_{OUT} = \pm 2.5\text{V}$ , $R_L = 150\Omega$ $V_{OUT} = \pm 1\text{V}$ , $R_L = 500\Omega$	$\pm 15\text{V}$	●	15			V/mV
			$\pm 15\text{V}$	●	5			V/mV
			$\pm 5\text{V}$	●	15			V/mV
			$\pm 5\text{V}$	●	5			V/mV
			$\pm 5\text{V}$	●	1			V/mV
			$\pm 2.5\text{V}$	●	5			V/mV

**ELECTRICAL CHARACTERISTICS**  $0^{\circ}\text{C} \leq T_A \leq 70^{\circ}\text{C}$ ,  $V_{CM} = 0\text{V}$  unless otherwise noted.

SYMBOL	PARAMETER	CONDITIONS	V <sub>SUPPLY</sub>	MIN	TYP	MAX	UNITS
V <sub>OUT</sub>	Output Swing	R <sub>L</sub> = 1k, V <sub>IN</sub> = ±40mV	±15V	●	13.2		±V
		R <sub>L</sub> = 500Ω, V <sub>IN</sub> = ±40mV	±15V	●	11.5		±V
		R <sub>L</sub> = 500Ω, V <sub>IN</sub> = ±40mV	±5V	●	3.4		±V
		R <sub>L</sub> = 150Ω, V <sub>IN</sub> = ±40mV	±5V	●	2.3		±V
		R <sub>L</sub> = 500Ω, V <sub>IN</sub> = ±40mV	±2.5V	●	1.2		±V
I <sub>OUT</sub>	Output Current	V <sub>OUT</sub> = ±11.5V	±15V	●	23.0		mA
		V <sub>OUT</sub> = ±2.3V	±5V	●	15.3		mA
I <sub>SC</sub>	Short-Circuit Current	V <sub>OUT</sub> = 0V, V <sub>IN</sub> = ±3V	±15V	●	25		mA
SR	Slew Rate	A <sub>V</sub> = -2, (Note 3)	±15V	●	225		V/μs
			±5V	●	125		V/μs
GBW	Gain-Bandwidth	f = 200kHz, R <sub>L</sub> = 2k	±15V	●	15		MHz
			±5V	●	12		MHz
I <sub>S</sub>	Supply Current		±15V	●		2.9	mA
			±5V	●		2.8	mA

**-40°C ≤ T<sub>A</sub> ≤ 85°C, V<sub>CM</sub> = 0V unless otherwise noted. (Note 6)**

SYMBOL	PARAMETER	CONDITIONS	V <sub>SUPPLY</sub>	MIN	TYP	MAX	UNITS
V <sub>OS</sub>	Input Offset Voltage		±15V	●		1.3	mV
			±5V	●		1.3	mV
			±2.5V	●		1.5	mV
	Input V <sub>OS</sub> Drift	(Note 5)	±2.5V to ±15V	●	5	8	μV/°C
I <sub>OS</sub>	Input Offset Current		±2.5V to ±15V	●		300	nA
I <sub>B</sub>	Input Bias Current		±2.5V to ±15V	●		900	nA
CMRR	Common Mode Rejection Ratio	V <sub>CM</sub> = ±12V V <sub>CM</sub> = ±2.5V V <sub>CM</sub> = ±0.5V	±15V	●	78		dB
			±5V	●	76		dB
			±2.5V	●	66		dB
PSRR	Power Supply Rejection Ratio	V <sub>S</sub> = ±2.5V to ±15V		●	90		dB
A <sub>VOL</sub>	Large-Signal Voltage Gain	V <sub>OUT</sub> = ±12V, R <sub>L</sub> = 1k V <sub>OUT</sub> = ±10V, R <sub>L</sub> = 500Ω V <sub>OUT</sub> = ±2.5V, R <sub>L</sub> = 1k V <sub>OUT</sub> = ±2.5V, R <sub>L</sub> = 500Ω V <sub>OUT</sub> = ±2.5V, R <sub>L</sub> = 150Ω V <sub>OUT</sub> = ±1V, R <sub>L</sub> = 500Ω	±15V	●	10.0		V/mV
			±15V	●	2.5		V/mV
			±5V	●	10.0		V/mV
			±5V	●	2.5		V/mV
			±5V	●	0.6		V/mV
			±2.5V	●	2.5		V/mV
V <sub>OUT</sub>	Output Swing	R <sub>L</sub> = 1k, V <sub>IN</sub> = ±40mV R <sub>L</sub> = 500Ω, V <sub>IN</sub> = ±40mV R <sub>L</sub> = 500Ω, V <sub>IN</sub> = ±40mV R <sub>L</sub> = 150Ω, V <sub>IN</sub> = ±40mV R <sub>L</sub> = 500Ω, V <sub>IN</sub> = ±40mV	±15V	●	13.0		±V
			±15V	●	11.0		±V
			±5V	●	3.4		±V
			±5V	●	2.1		±V
			±2.5V	●	1.2		±V
I <sub>OUT</sub>	Output Current	V <sub>OUT</sub> = ±11V V <sub>OUT</sub> = ±2.1V	±15V	●	22		mA
			±5V	●	14		mA
I <sub>SC</sub>	Short-Circuit Current	V <sub>OUT</sub> = 0V, V <sub>IN</sub> = ±3V	±15V	●	24		mA
SR	Slew Rate	A <sub>V</sub> = -2, (Note 3)	±15V	●	180		V/μs
			±5V	●	100		V/μs
GBW	Gain-Bandwidth	f = 200kHz, R <sub>L</sub> = 2k	±15V	●	14		MHz
			±5V	●	11		MHz
I <sub>S</sub>	Supply Current		±15V	●		3.0	mA
			±5V	●		2.9	mA

## ELECTRICAL CHARACTERISTICS

The ● denotes specifications that apply over the full specified temperature range.

**Note 1:** Differential inputs of ±10V are appropriate for transient operation only, such as during slewing. Large, sustained differential inputs will cause excessive power dissipation and may damage the part. See Input Considerations in the Applications Information section of this data sheet for more details.

**Note 2:** A heat sink may be required to keep the junction temperature below absolute maximum when the output is shorted indefinitely.

**Note 3:** Slew rate is measured between ±10V on the output with ±6V input for ±15V supplies and ±1V on the output with ±1.75V input for ±5V supplies.

**Note 4:** Full power bandwidth is calculated from the slew rate measurement:  $FPBW = SR/2\pi V_p$ .

**Note 5:** This parameter is not 100% tested.

**Note 6:** The LT1357 is designed, characterized and expected to meet these extended temperature limits, but is not tested at -40°C and at 85°C. Guaranteed I grade parts are available; consult factory.

## TYPICAL PERFORMANCE CHARACTERISTICS

Supply Current vs Supply Voltage and Temperature

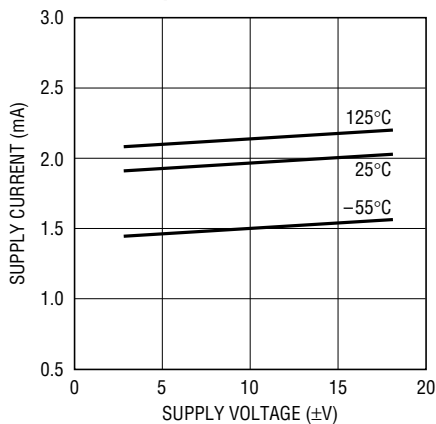

1357 G01

Input Common-Mode Range vs Supply Voltage

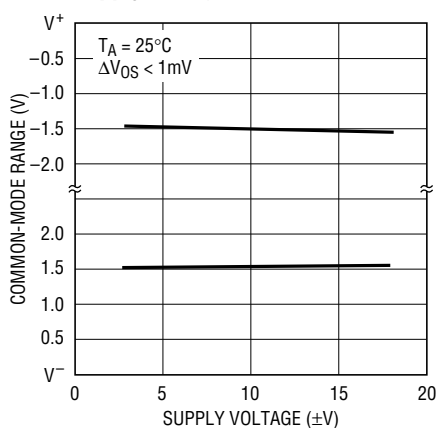

1357 G02

Input Bias Current vs Input Common-Mode Voltage

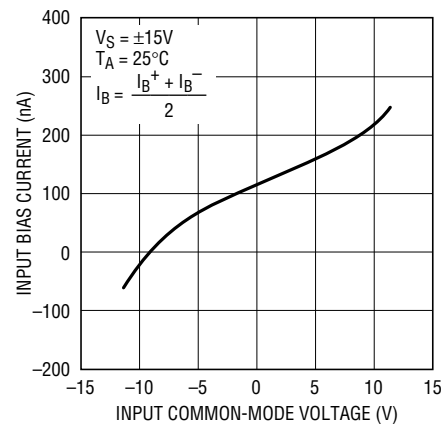

1357 G03

Input Bias Current vs Temperature

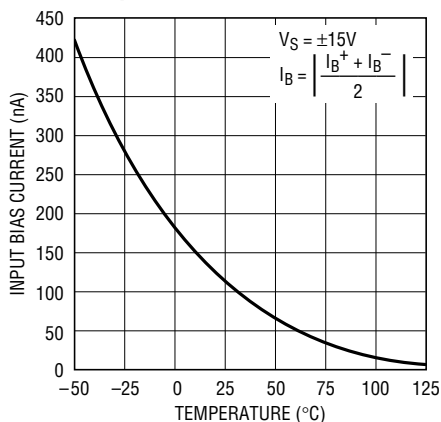

1358/1359 G04

Input Noise Spectral Density

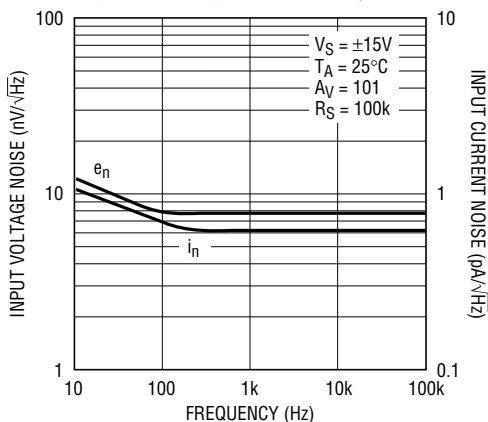

1357 G05

Open-Loop Gain vs Resistive Load

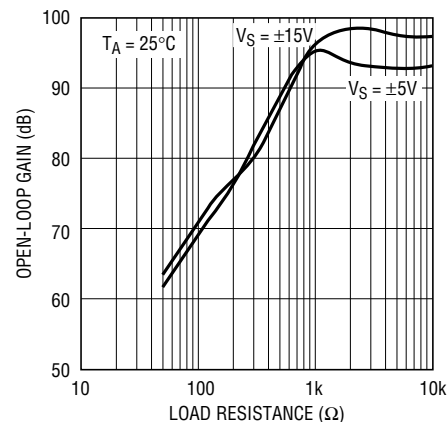

1357 G06

# TYPICAL PERFORMANCE CHARACTERISTICS

**Open-Loop Gain vs Temperature**

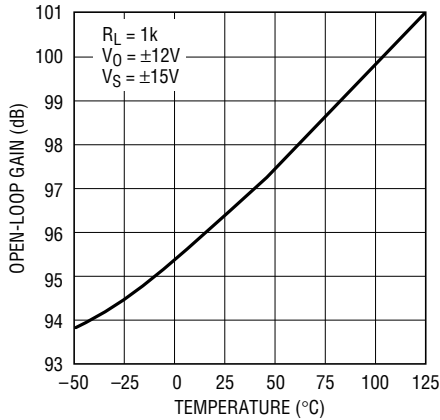

1357 G07

**Output Voltage Swing vs Supply Voltage**

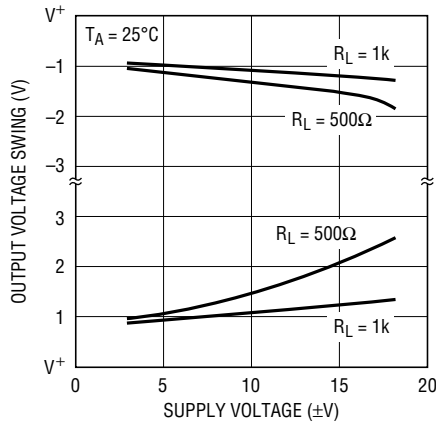

1357 G08

**Output Voltage Swing vs Load Current**

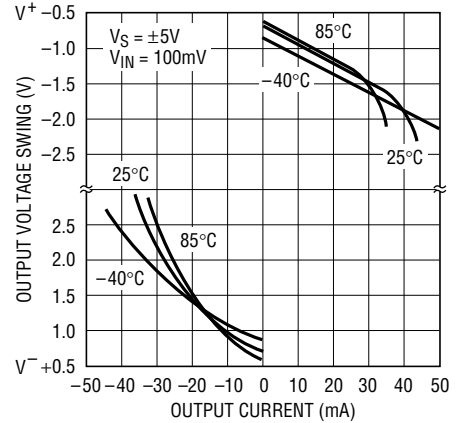

1357 G09

**Output Short-Circuit Current vs Temperature**

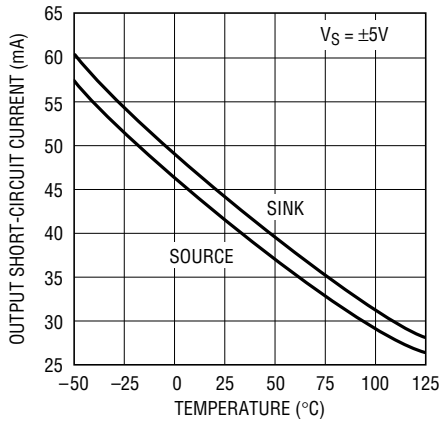

1357 G10

**Settling Time vs Output Step (Noninverting)**

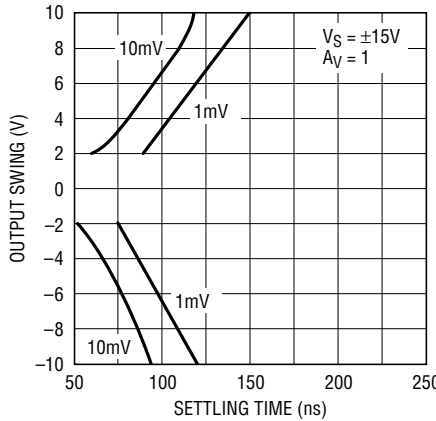

1357 G11

**Settling Time vs Output Step (Inverting)**

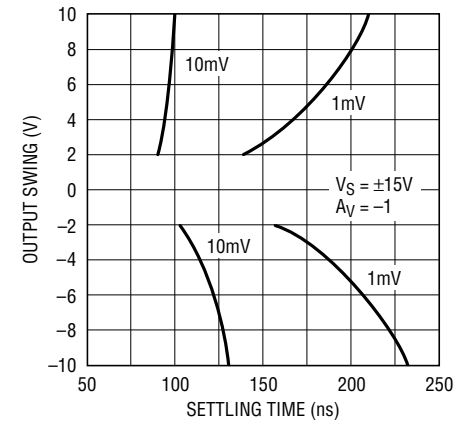

1357 G12

**Output Impedance vs Frequency**

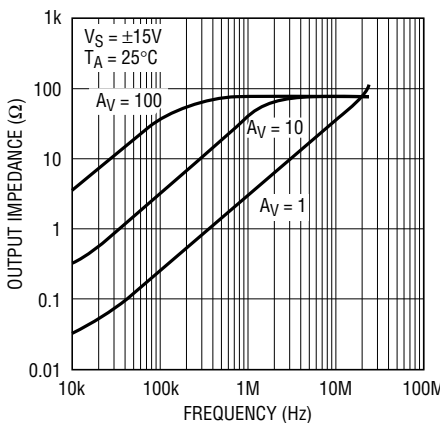

1357 G13

**Gain and Phase vs Frequency**

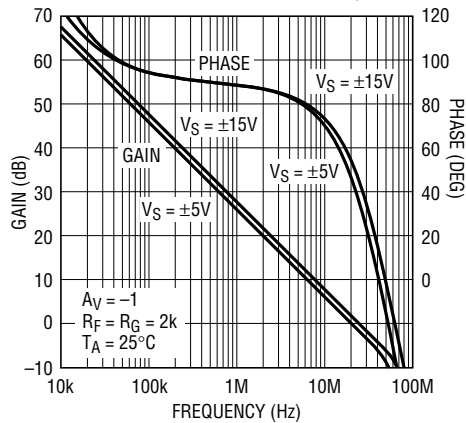

1357 G14

**Gain-Bandwidth and Phase Margin vs Supply Voltage**

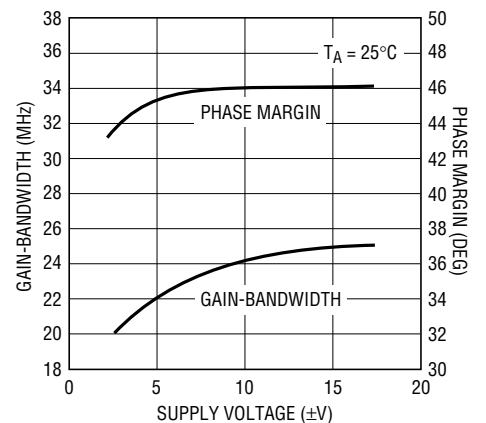

1357 G15

# TYPICAL PERFORMANCE CHARACTERISTICS

**Gain-Bandwidth and Phase Margin vs Temperature**

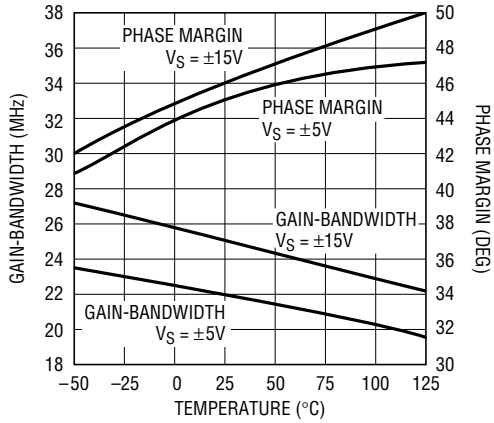

1357 G16

**Frequency Response vs Supply Voltage ( $A_V = 1$ )**

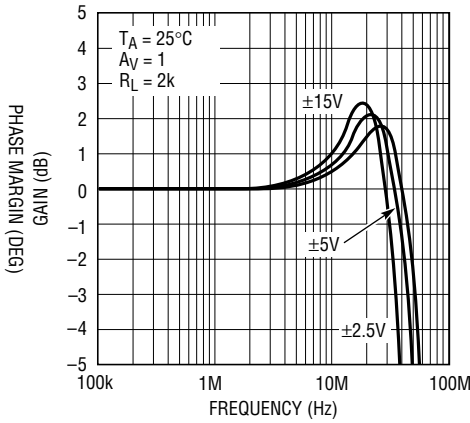

1357 G17

**Frequency Response vs Supply Voltage ( $A_V = -1$ )**

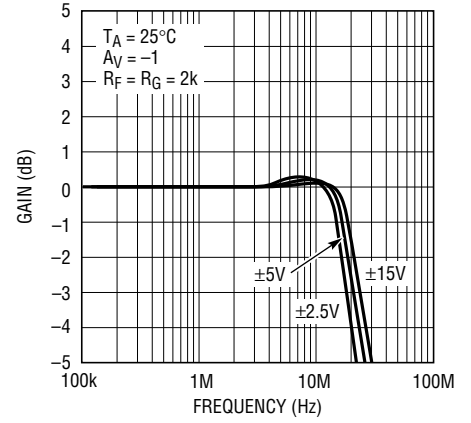

1357 G18

**Frequency Response vs Capacitive Load**

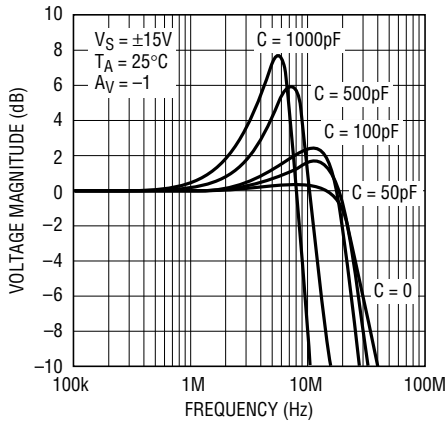

1358/1359 G19

**Power Supply Rejection Ratio vs Frequency**

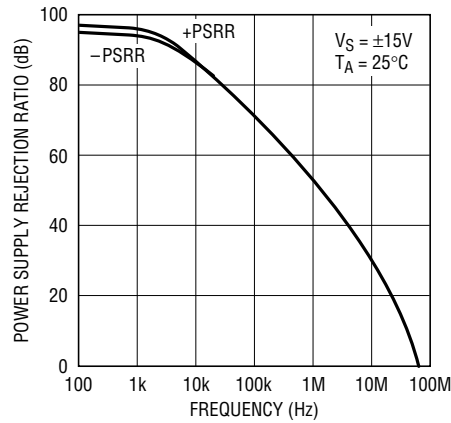

1357 G20

**Common-Mode Rejection Ratio vs Frequency**

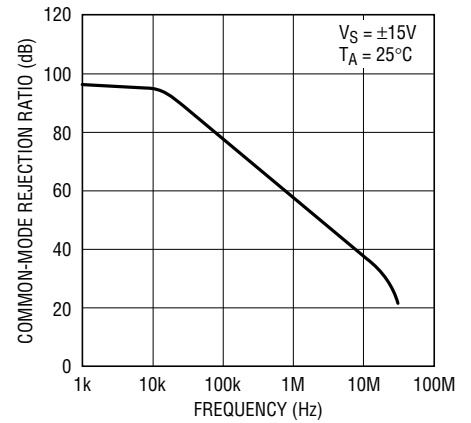

1357 G21

**Slew Rate vs Supply Voltage**

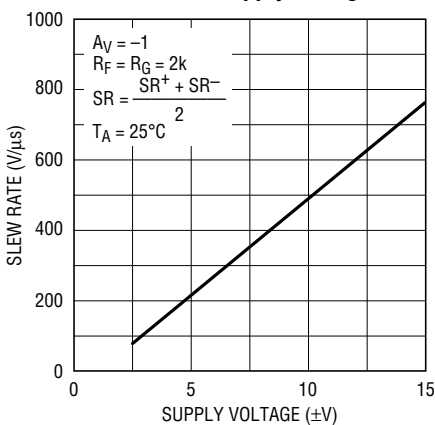

1357 G22

**Slew Rate vs Temperature**

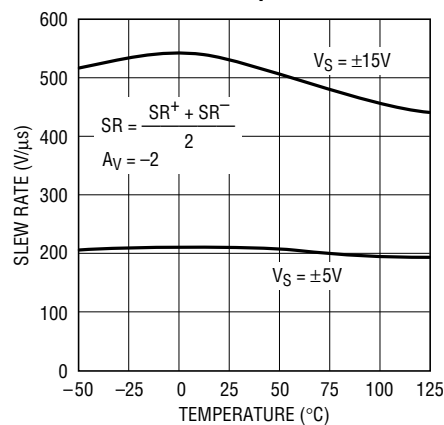

1357 G23

**Slew Rate vs Input Level**

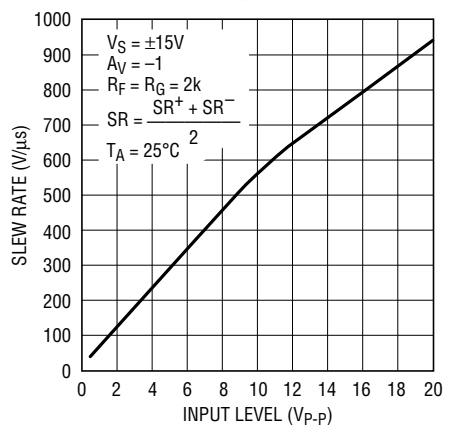

1357 G24

# TYPICAL PERFORMANCE CHARACTERISTICS

**Total Harmonic Distortion vs Frequency**

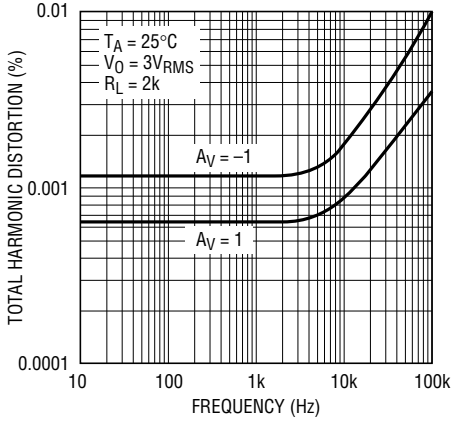

1357 G25

**Undistorted Output Swing vs Frequency ( $\pm 15\text{V}$ )**

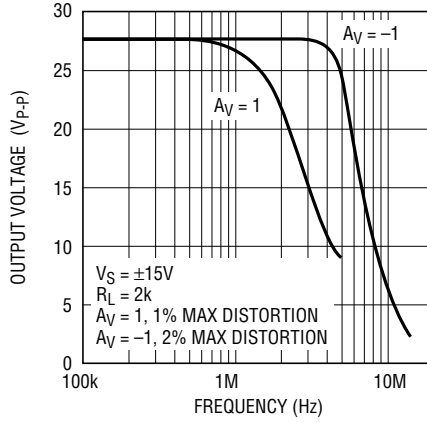

1357 G26

**Undistorted Output Swing vs Frequency ( $\pm 5\text{V}$ )**

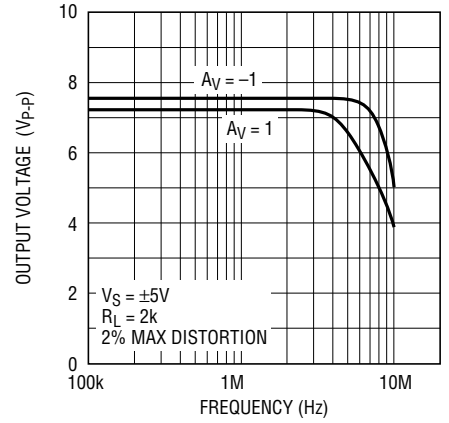

1357 G27

**2nd and 3rd Harmonic Distortion vs Frequency**

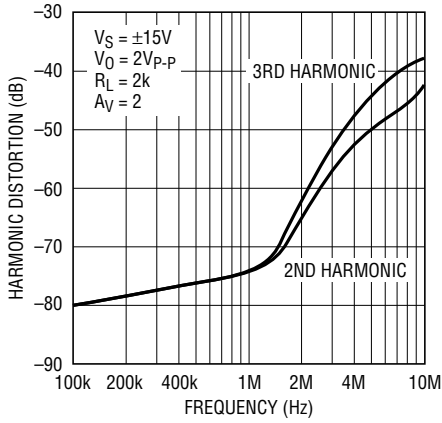

1357 G28

**Differential Gain and Phase vs Supply Voltage**

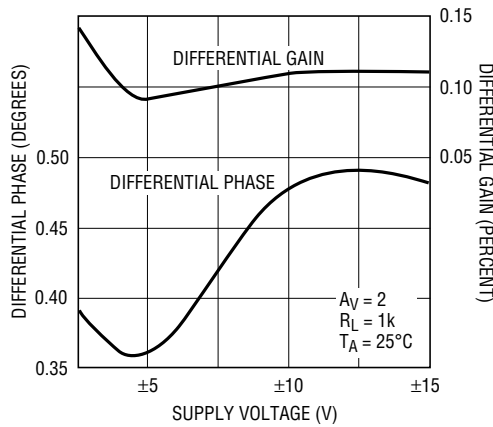

1354 G29

**Capacitive Load Handling**

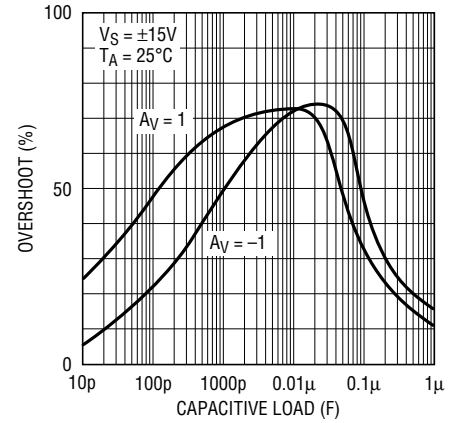

1357 G30

**Small-Signal Transient ( $A_V = 1$ )**

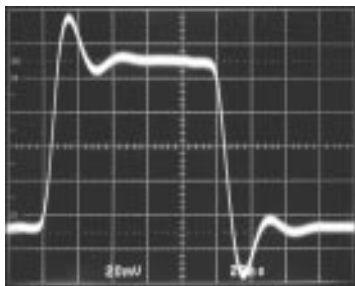

1357 TA31

**Small-Signal Transient ( $A_V = -1$ )**

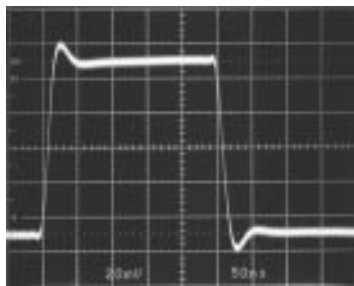

1357 TA32

**Small-Signal Transient ( $A_V = -1, C_L = 1000\text{pF}$ )**

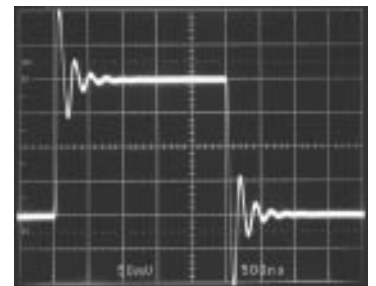

1357 TA33



## TYPICAL PERFORMANCE CHARACTERISTICS

Large-Signal Transient  
( $A_V = 1$ )

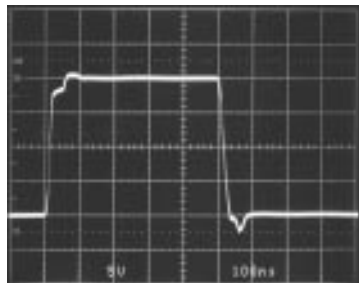

1357 TA34

Large-Signal Transient  
( $A_V = -1$ )

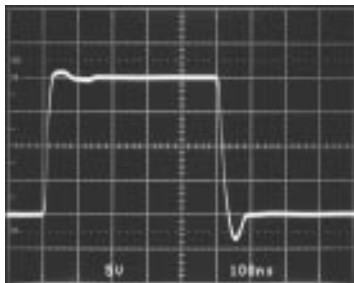

1357 TA35

Large-Signal Transient  
( $A_V = 1, C_L = 10,000\text{pF}$ )

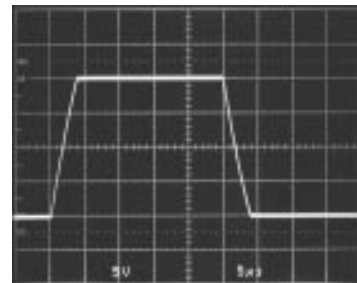

1357 TA36

## APPLICATIONS INFORMATION

The LT1357 may be inserted directly into many high speed amplifier applications improving both DC and AC performance, provided that the nulling circuitry is removed. The suggested nulling circuit for the LT1357 is shown below.

### Offset Nulling

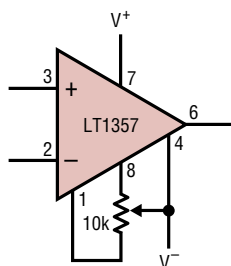

1357 AI01

### Layout and Passive Components

The LT1357 amplifier is easy to apply and tolerant of less than ideal layouts. For maximum performance (for example, fast settling time) use a ground plane, short lead lengths and RF-quality bypass capacitors (0.01 $\mu\text{F}$  to 0.1 $\mu\text{F}$ ). For high drive current applications use low ESR bypass capacitors (1 $\mu\text{F}$  to 10 $\mu\text{F}$  tantalum). Sockets should be avoided when maximum frequency performance is required, although low profile sockets can provide reasonable performance up to 50MHz. For more details see Design Note 50.

The parallel combination of the feedback resistor and gain setting resistor on the inverting input can combine with the input capacitance to form a pole which can cause peaking or oscillations. For feedback resistors greater than 5k $\Omega$ , a parallel capacitor of value

$$C_F > (R_G \cdot C_{IN})/R_F$$

should be used to cancel the input pole and optimize dynamic performance. For unity-gain applications where a large feedback resistor is used,  $C_F$  should be greater than or equal to  $C_{IN}$ .

### Capacitive Loading

The LT1357 is stable with any capacitive load. This is accomplished by sensing the load induced output pole and adding compensation at the amplifier gain node. As the capacitive load increases, both the bandwidth and phase margin decrease so there will be peaking in the frequency domain and in the transient response as shown in the typical performance curves. The photo of the small-signal response with 1000pF load shows 50% peaking. The large-signal response with a 10,000pF load shows the output slew rate being limited to 5V/ $\mu\text{s}$  by the short-circuit current. Coaxial cable can be driven directly, but for best pulse fidelity a resistor of value equal to the characteristic impedance of the cable (i.e., 75 $\Omega$ ) should be placed in

## APPLICATIONS INFORMATION

series with the output. The other end of the cable should be terminated with the same value resistor to ground.

### Input Considerations

Each of the LT1357 inputs is the base of an NPN and a PNP transistor whose base currents are of opposite polarity and provide first-order bias current cancellation. Because of variation in the matching of NPN and PNP beta, the polarity of the input bias current can be positive or negative. The offset current does not depend on NPN/PNP beta matching and is well controlled. The use of balanced source resistance at each input is recommended for applications where DC accuracy must be maximized.

The inputs can withstand transient differential input voltages up to 10V without damage and need no clamping or source resistance for protection. Differential inputs, however, generate large supply currents (tens of mA) as required for high slew rates. If the device is used with sustained differential inputs, the average supply current will increase, excessive power dissipation will result and the part may be damaged. *The part should not be used as a comparator, peak detector or other open-loop application with large, sustained differential inputs.* Under normal, closed-loop operation, an increase of power dissipation is only noticeable in applications with large slewing outputs and is proportional to the magnitude of the differential input voltage and the percent of the time that the inputs are apart. Measure the average supply current for the application in order to calculate the power dissipation.

### Power Dissipation

The LT1357 combines high speed and large output drive in a small package. Because of the wide supply voltage range, it is possible to exceed the maximum junction temperature under certain conditions. Maximum junction temperature ( $T_J$ ) is calculated from the ambient temperature ( $T_A$ ) and power dissipation ( $P_D$ ) as follows:

$$\text{LT1357CN8: } T_J = T_A + (P_D \cdot 130^\circ\text{C/W})$$

$$\text{LT1357CS8: } T_J = T_A + (P_D \cdot 190^\circ\text{C/W})$$

Worst-case power dissipation occurs at the maximum supply current and when the output voltage is at 1/2 of either supply voltage (or the maximum swing if less than 1/2 supply voltage). Therefore  $P_{D\text{MAX}}$  is:

$$P_{D\text{MAX}} = (V^+ - V^-)(I_{S\text{MAX}}) + (V^+/2)^2/R_L$$

Example: LT1357CS8 at 70°C,  $V_S = \pm 15\text{V}$ ,  $R_L = 120\Omega$   
(Note: the minimum short-circuit current at 70°C is 25mA, so the output swing is guaranteed only to 3V with 120Ω.)

$$P_{D\text{MAX}} = (30\text{V} \cdot 2.9\text{mA}) + (15\text{V} - 3\text{V})(25\text{mA}) = 387\text{mW}$$

$$T_{J\text{MAX}} = 70^\circ\text{C} + (387\text{mW} \cdot 190^\circ\text{C/W}) = 144^\circ\text{C}$$

### Circuit Operation

The LT1357 circuit topology is a true voltage feedback amplifier that has the slewing behavior of a current feedback amplifier. The operation of the circuit can be understood by referring to the simplified schematic. The inputs are buffered by complementary NPN and PNP emitter followers which drive a 500Ω resistor. The input voltage appears across the resistor generating currents which are mirrored into the high impedance node. Complementary followers form an output stage which buffers the gain node from the load. The bandwidth is set by the input resistor and the capacitance on the high impedance node. The slew rate is determined by the current available to charge the gain node capacitance. This current is the differential input voltage divided by  $R_1$ , so the slew rate is proportional to the input. Highest slew rates are therefore seen in the lowest gain configurations. For example, a 10V output step in a gain of 10 has only a 1V input step, whereas the same output step in unity-gain has a ten times greater input step. The curve of Slew Rate vs Input Level illustrates this relationship. The LT1357 is tested for slew rate in a gain of -2 so higher slew rates can be expected in gains of 1 and -1, and lower slew rates in higher gain configurations.

The RC network across the output stage is bootstrapped when the amplifier is driving a light or moderate load and

## APPLICATIONS INFORMATION

has no effect under normal operation. When driving a capacitive load (or a low value resistive load) the network is incompletely bootstrapped and adds to the compensation at the high impedance node. The added capacitance slows down the amplifier which improves the phase margin by moving the unity-gain frequency away from the

pole formed by the output impedance and the capacitive load. The zero created by the RC combination adds phase to ensure that even for very large load capacitances, the total phase lag can never exceed 180 degrees (zero phase margin) and the amplifier remains stable.

## SIMPLIFIED SCHEMATIC

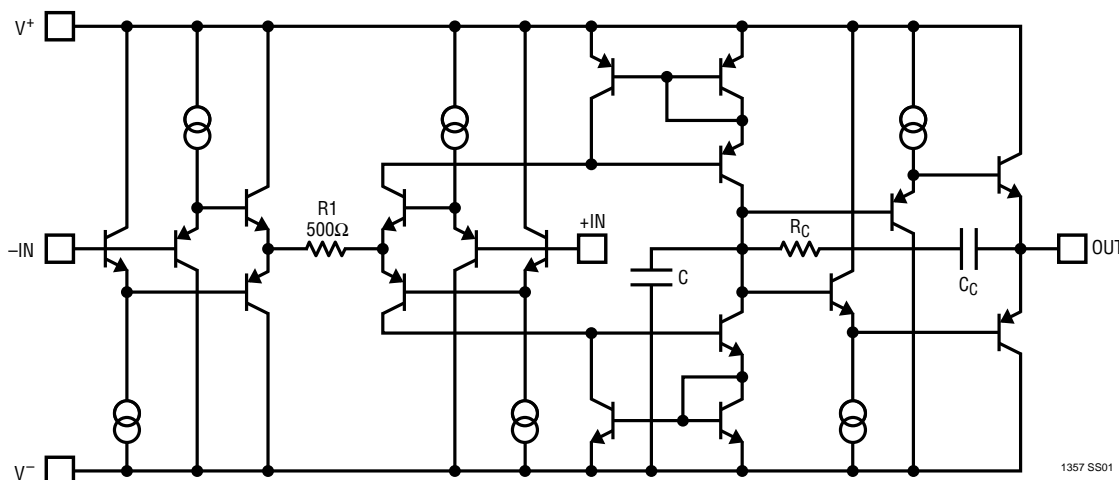

## PACKAGE DESCRIPTION Dimensions in inches (millimeters) unless otherwise noted.

**N8 Package**  
**8-Lead PDIP (Narrow 0.300)**  
 (LTC DWG # 05-08-1510)

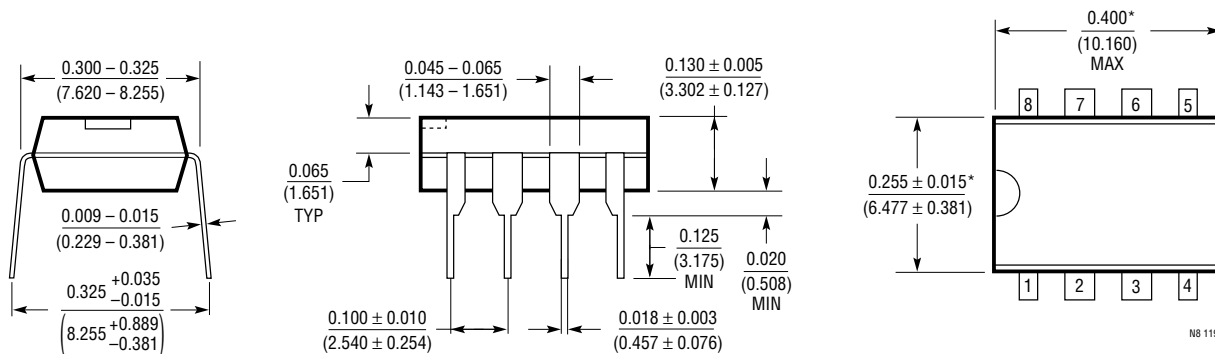

\*THESE DIMENSIONS DO NOT INCLUDE MOLD FLASH OR PROTRUSIONS.  
 MOLD FLASH OR PROTRUSIONS SHALL NOT EXCEED 0.010 INCH (0.254mm)

**PACKAGE DESCRIPTION**

Dimensions in inches (millimeters) unless otherwise noted.

**S8 Package**  
**8-Lead Plastic Small Outline (Narrow 0.150)**  
 (LTC DWG # 05-08-1610)

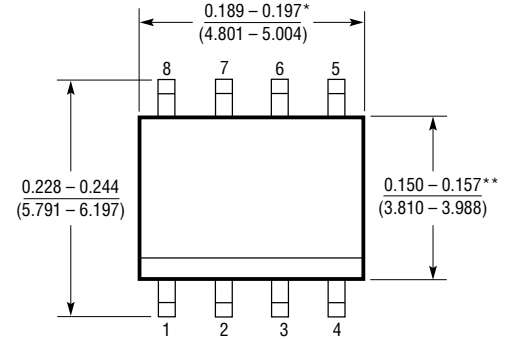
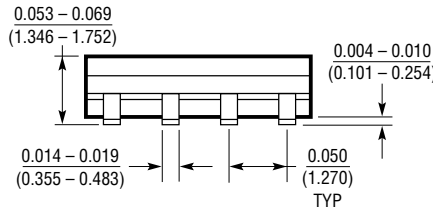
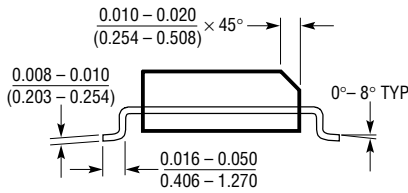

\*DIMENSION DOES NOT INCLUDE MOLD FLASH. MOLD FLASH SHALL NOT EXCEED 0.006" (0.152mm) PER SIDE  
 \*\*DIMENSION DOES NOT INCLUDE INTERLEAD FLASH. INTERLEAD FLASH SHALL NOT EXCEED 0.010" (0.254mm) PER SIDE

S08 0996

**TYPICAL APPLICATIONS**

**Instrumentation Amplifier**

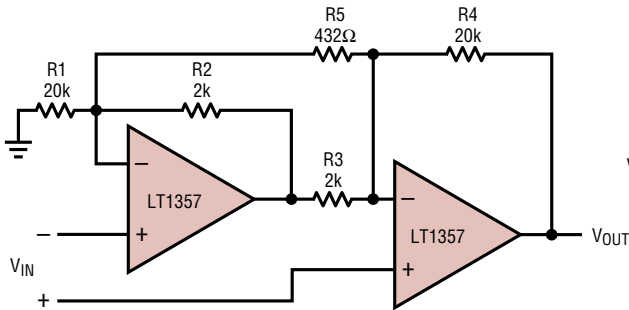

$$A_v = \frac{R_4}{R_3} \left[ 1 + \frac{1}{2} \left( \frac{R_2}{R_1} + \frac{R_3}{R_4} \right) + \frac{R_2 + R_3}{R_5} \right] = 104$$

TRIM R5 FOR GAIN  
 TRIM R1 FOR COMMON MODE REJECTION  
 BW = 250kHz

1357 TA03

**200kHz, 4th Order Butterworth Filter**

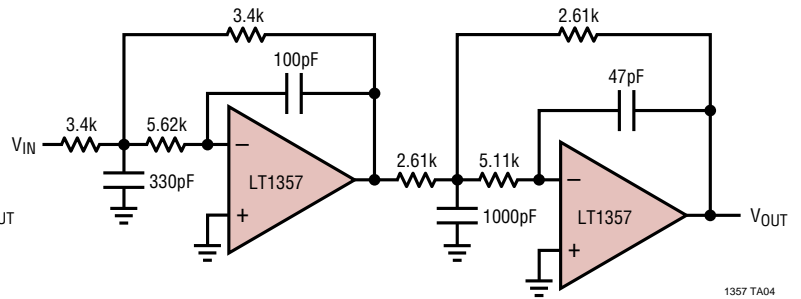

1357 TA04

**RELATED PARTS**

PART NUMBER	DESCRIPTION	COMMENTS
LT1358/LT1359	Dual/Quad 2mA, 25MHz, 600V/μs Op Amp	Good DC Precision, Stable with All Capacitive Loads
LT1360	4mA, 50MHz, 800V/μs Op Amp	Good DC Precision, Stable with All Capacitive Loads
LT1361/LT1362	Dual/Quad 4mA, 50MHz, 800V/μs Op Amp	Good DC Precision, Stable with All Capacitive Loads