

1MHz Off-Line Current Mode PWM and DC/DC Converter

FEATURES

- **Current Mode Operation to 1MHz**
- **30ns Current Sense Delay**
- **< 250 μ A Low Start-Up Current**
- **Current Sense Leading Edge Blanking**
- Pin Compatible with UC1842
- Undervoltage Lockout with Hysteresis
- No Cross-Conduction Current
- Trimmed Bandgap Reference
- 1A Totem Pole Output
- Trimmed Oscillator Frequency and Sink Current
- Active Pull-Down on Reference and Output During Undervoltage Lockout
- 18V High Level Output Clamp

APPLICATIONS

- Off-Line Converters
- DC/DC Converters

Device	Start-Up Threshold	Minimum Operating Voltage	Maximum Duty Cycle	Replaces
LT1246	16V	10V	100%	UC1842
LT1247	8.4V	7.6V	100%	UC1843

DESCRIPTION

The LT[®]1246/LT1247 are 8-pin, fixed frequency, current mode, pulse width modulators. These devices are designed to be improved plug compatible versions of the industry standard UC1842 PWM circuit. The LT1246/LT1247 are optimized for off-line and DC/DC converter applications. They contain a temperature compensated reference, high gain error amplifier, current sensing comparator, and a high current totem pole output stage ideally suited to driving power MOSFETs. Start-up current has been reduced to less than 250 μ A. Cross-conduction current spikes in the totem pole output stage have been eliminated, making 1MHz operation practical. Several new features have been incorporated. Leading edge blanking has been added to the current sense comparator. This minimizes or eliminates the filter that is normally required. Eliminating this filter allows the current sense loop to operate with minimum delays. Trims have been added to the oscillator circuit for both frequency and sink current, and both of these parameters are tightly specified. The output stage is clamped to a maximum V_{OUT} of 18V in the on state. The output and the reference output are actively pulled low during under-voltage lockout.

 LTC and LT are registered trademarks of Linear Technology Corporation.

BLOCK DIAGRAM

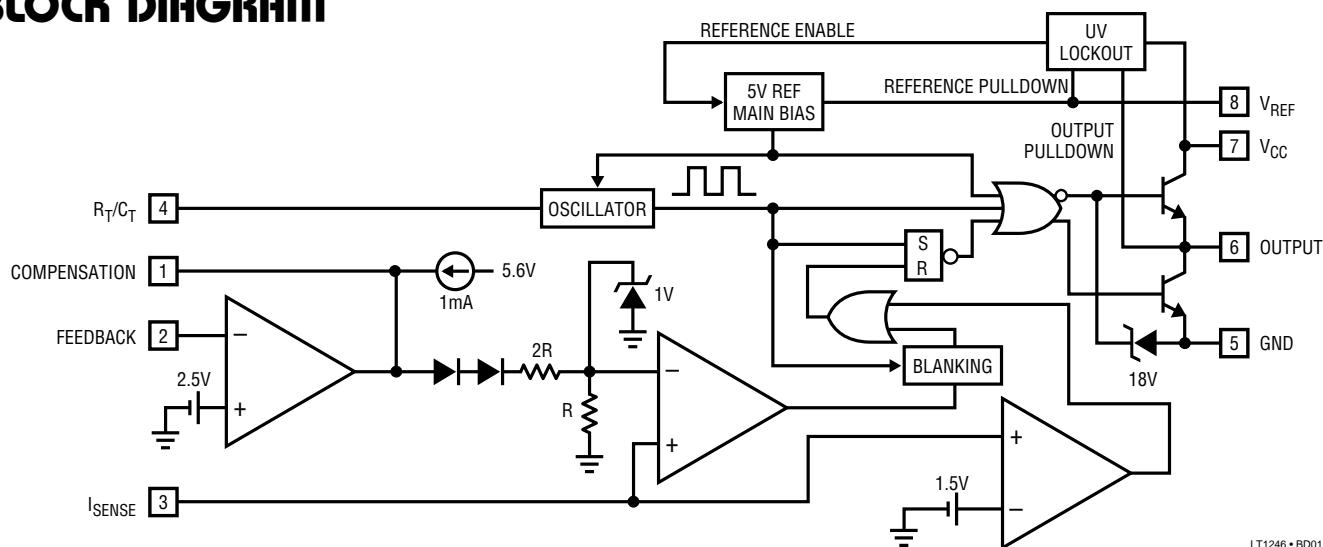

LT1246/LT1247

ABSOLUTE MAXIMUM RATINGS

Supply Voltage	25V
Output Current	±1A*
Output Energy (Capacitive Load per Cycle)	5μJ
Analog Inputs (Pins 2, 3)	-0.3 to 6V
Error Amplifier Output Sink Current	10mA
Power Dissipation at $T_A \leq 25^\circ\text{C}$	1W
Operating Junction Temperature Range	
LT1246C/LT1247C	0°C to 100°C
Storage Temperature Range	-65°C to 150°C
Lead Temperature (Soldering, 10 sec)	300°C

*The 1A rating for output current is based on transient switching requirements.

PACKAGE/ORDER INFORMATION

<p>TOP VIEW</p> <p>COMP 1 8 VREF FB 2 7 VCC ISENSE 3 6 OUTPUT RT/CT 4 5 GND</p> <p>N8 PACKAGE 8-LEAD PDIP S8 PACKAGE 8-LEAD PLASTIC SO</p> <p>$T_{JMAX} = 100^\circ\text{C}$, $\theta_{JA} = 130^\circ\text{C/W}$ (N8) $T_{JMAX} = 100^\circ\text{C}$, $\theta_{JA} = 150^\circ\text{C/W}$ (S8)</p>	ORDER PART NUMBER
	LT1246CN8 LT1246CS8 LT1247CN8 LT1247CS8
	S8 PART MARKING
	1246 1247

Consult factory for Industrial and Military grade parts.

ELECTRICAL CHARACTERISTICS (Notes 1, 2)

PARAMETER	CONDITIONS	MIN	TYP	MAX	UNITS	
Reference Section						
Output Voltage	$I_O = 1\text{mA}$, $T_J = 25^\circ\text{C}$	4.925	5.000	5.075	V	
Line Regulation	$12\text{V} < V_{CC} < 25\text{V}$	●	3	20	mV	
Load Regulation	$1\text{mA} < I_{REF} < 20\text{mA}$	●	-6	-25	mV	
Temperature Stability			0.1		mV/°C	
Total Output Variation	Line, Load, Temperature	●	4.87	5.13	V	
Output Noise Voltage	$10\text{Hz} < F < 10\text{kHz}$, $T_J = 25^\circ\text{C}$		50		μV	
Long-Term Stability	$T_A = 125^\circ\text{C}$, 1000 Hrs.		5	25	mV	
Output Short-Circuit Current		●	-30	-90	-180	mA
Oscillator Section						
Initial Accuracy	$R_T = 10\text{k}$, $C_T = 3.3\text{nF}$, $T_J = 25^\circ\text{C}$ $R_T = 6.2\text{k}$, $C_T = 500\text{pF}$, $T_J = 25^\circ\text{C}$		47.5 465	50 500	52.5 535	kHz kHz
Voltage Stability	$12\text{V} < V_{CC} < 25\text{V}$, $T_J = 25^\circ\text{C}$			1	%	
Temperature Stability	$T_{MIN} < T_J < T_{MAX}$		-0.05		%/°C	
Amplitude	Pin 4		1.7		V	
Clock Ramp Reset Current	V_{OSC} (Pin 4) = 2V, $T_J = 25^\circ\text{C}$		7.9	8.2	8.5	mA
Error Amplifier Section						
Feedback Pin Input Voltage	$V_{PIN 1} = 2.5\text{V}$	●	2.42	2.50	2.58	V
Input Bias Current	$V_{FB} = 2.5\text{V}$	●			-2	μA
Open-Loop Voltage Gain	$2 < V_O < 4\text{V}$	●	65	90		dB
Unity-Gain Bandwidth	$T_J = 25^\circ\text{C}$		1	2		MHz
Power Supply Rejection Ratio	$12\text{V} < V_{CC} < 25\text{V}$	●	60			dB
Output Sink Current	$V_{PIN 2} = 2.7\text{V}$, $V_{PIN 1} = 1.1\text{V}$	●	2	6		mA
Output Source Current	$V_{PIN 2} = 2.3\text{V}$, $V_{PIN 1} = 5\text{V}$	●	-0.5	-0.75		mA

ELECTRICAL CHARACTERISTICS (Notes 1, 2)

PARAMETER	CONDITIONS		MIN	TYP	MAX	UNITS
Error Amplifier Section						
Output Voltage High Level	$V_{PIN\ 2} = 2.3V, R_L = 15k\ to\ GND$	●	5	5.6		V
Output Voltage Low Level	$V_{PIN\ 2} = 2.7V, R_L = 15k\ to\ Pin\ 8$	●		0.2	1.1	V
Current Sense Section						
Gain		●	2.85	3.00	3.15	V/V
Maximum Current Sense Input Threshold	$V_{PIN\ 3} < 1.1V$	●	0.90	1.00	1.10	V
Power Supply Rejection Ratio				70		dB
Input Bias Current		●		-1	-10	μA
Delay to Output				30		ns
Blanking Time				60		ns
Blanking Override Voltage				1.5		V
Output Section						
Output Low Level	$I_{OUT} = 20mA$ $I_{OUT} = 200mA$	●		0.25	0.4	V
		●		0.75	2.2	V
Output High Level	$I_{OUT} = 20mA$ $I_{OUT} = 200mA$	●	12.0			V
		●	11.75			V
Rise Time	$C_L = 1nF, T_J = 25^\circ C$			30	70	ns
Fall Time	$C_L = 1nF, T_J = 25^\circ C$			20	60	ns
Output Clamp Voltage	$I_O = 1mA$	●		18	19	V
Undervoltage Lockout						
Start-Up Threshold	LT1246	●	15	16	17	V
	LT1247	●	7.8	8.4	9.0	V
Minimum Operating Voltage	LT1246	●	9.0	10	11	V
	LT1247	●	7.0	7.6	8.2	V
Hysteresis	LT1246	●	5.5	6.0		V
	LT1247	●	0.4	0.8		V
PWM						
Maximum Duty Cycle	$T_J = 25^\circ C$		94		100	%
Minimum Duty Cycle	$T_J = 25^\circ C$			0		%
Total Device						
Start-Up Current		●		170	250	μA
Operating Current		●		13	20	mA

The ● denotes those specifications which apply over the full operating temperature range.

Note 1: Unless otherwise specified, $V_{CC} = 15V, R_T = 10k, C_T = 3.3nF$.

Note 2: Low duty cycle pulse techniques are used during test to maintain junction temperature close to ambient.

TYPICAL PERFORMANCE CHARACTERISTICS

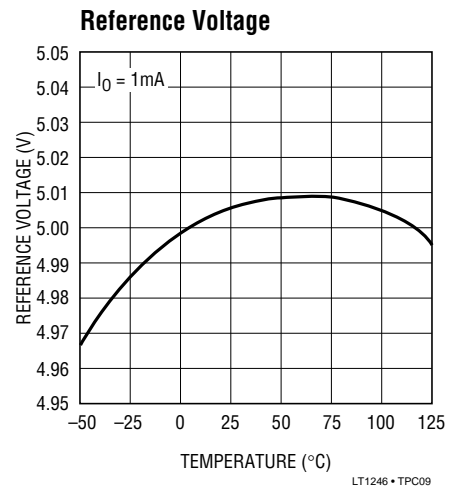
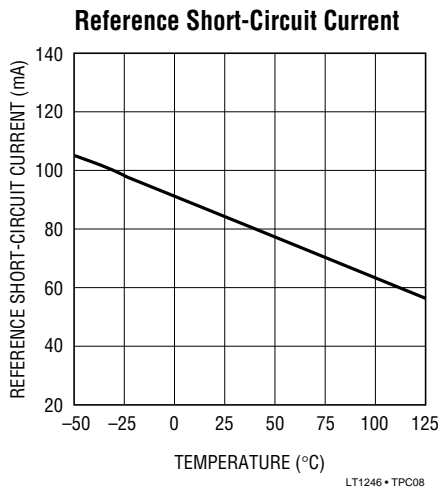
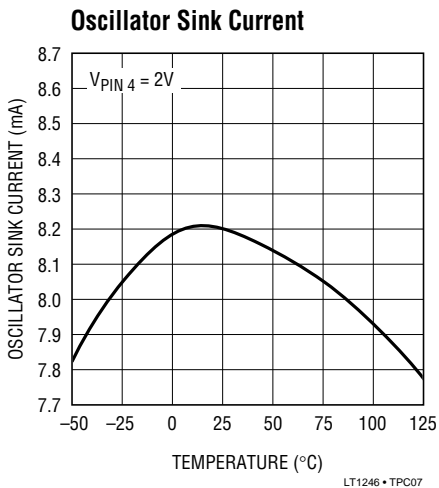
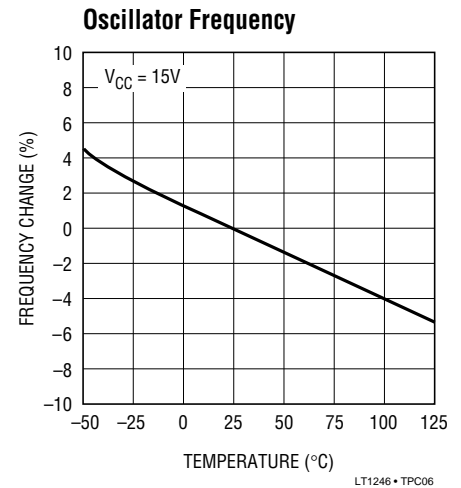
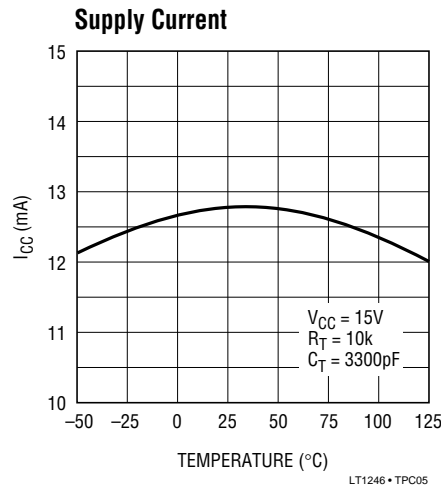
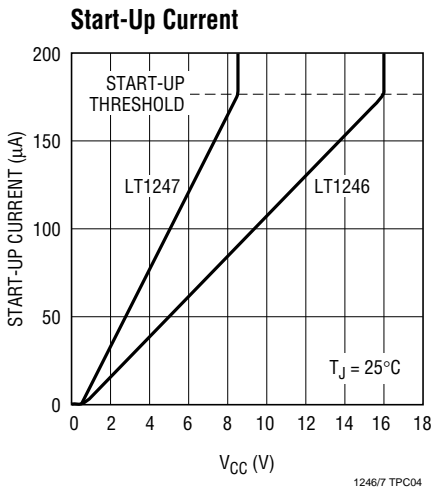
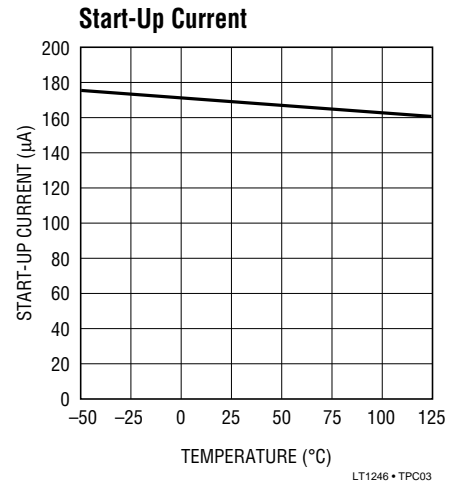
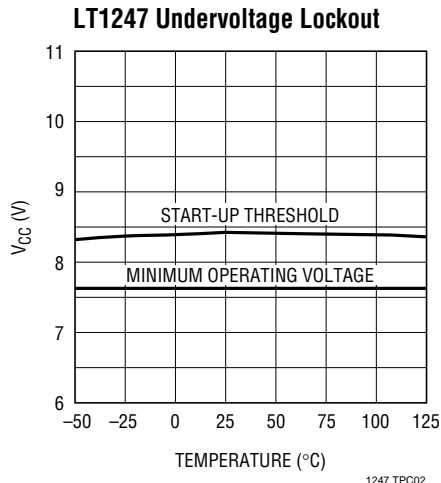
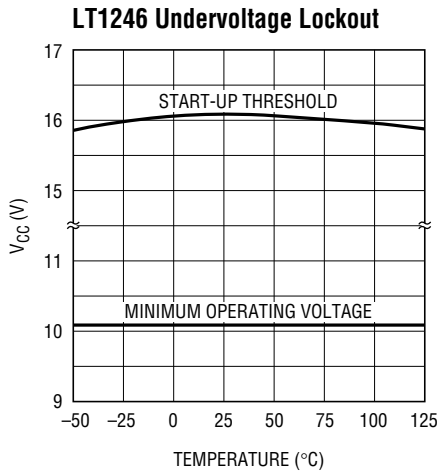

TYPICAL PERFORMANCE CHARACTERISTICS

Feedback Pin Input Voltage

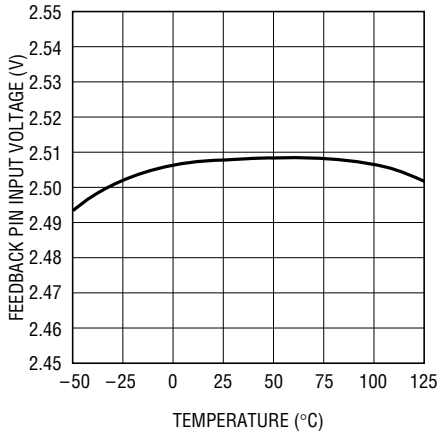

LT1246 • TPC10

Current Sense Clamp Voltage

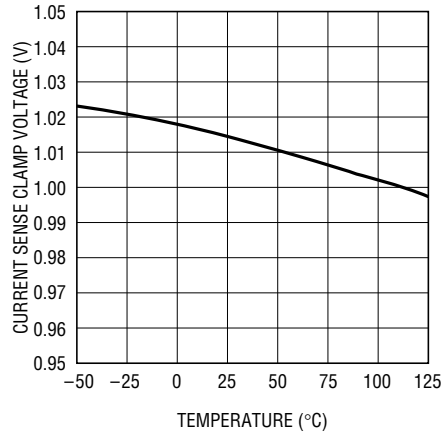

LT1246 • TPC11

High Level Output Saturation Voltage

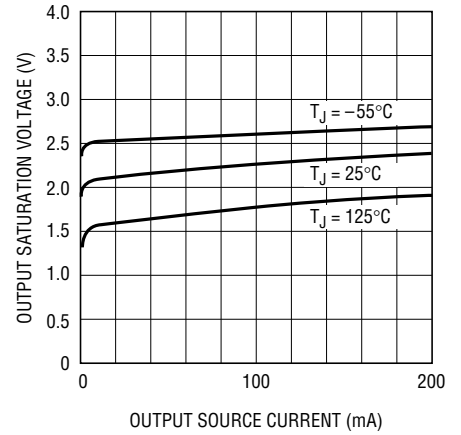

LT1246 • TPC12

Low Level Output Saturation Voltage

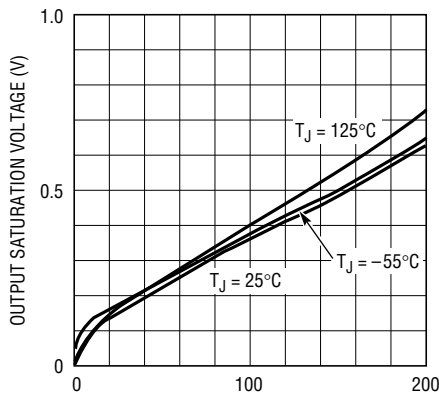

LT1246 • TPC13

Low Level Output Saturation Voltage During Undervoltage Lockout

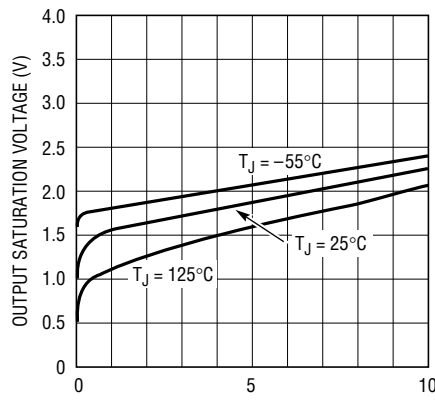

LT1246 • TPC14

Supply Current vs Oscillator Frequency

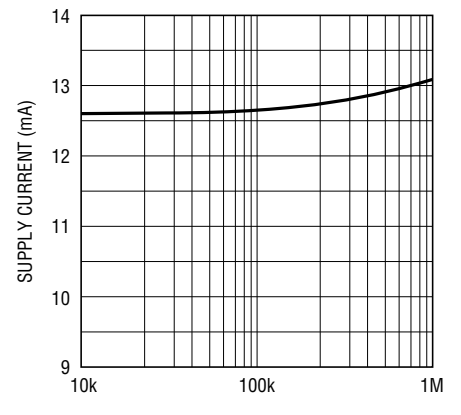

LT1246 • TPC15

Error Amplifier Open-Loop Gain and Phase

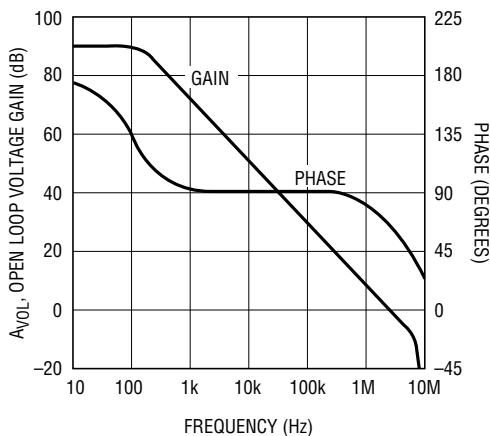

LT1246 • TPC16

Current Sense Input Threshold

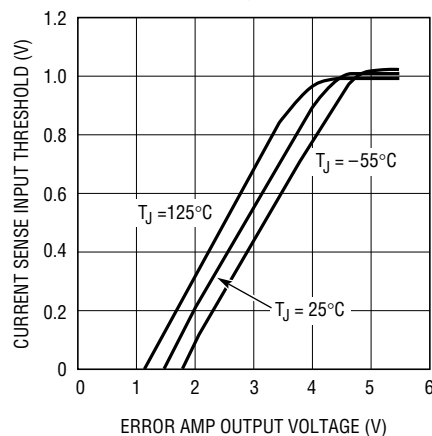

LT1246 • TPC17

TYPICAL PERFORMANCE CHARACTERISTICS

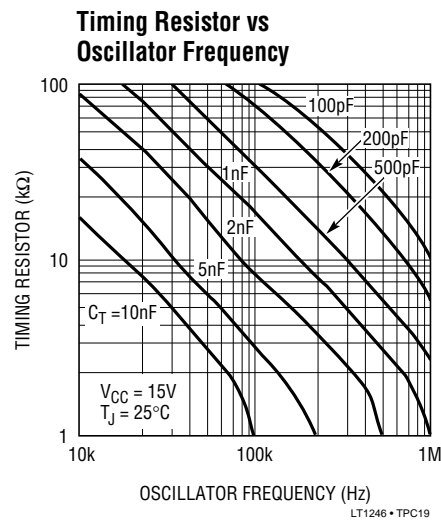
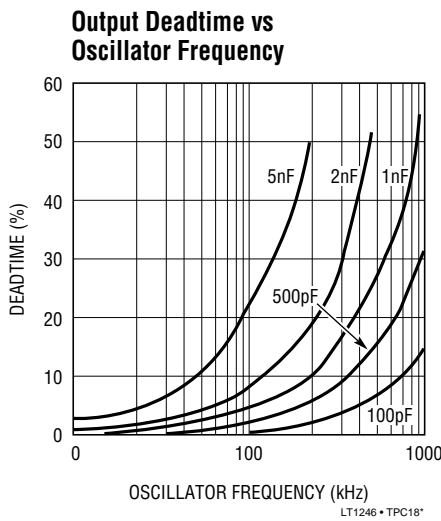

Output Rise and Fall Time

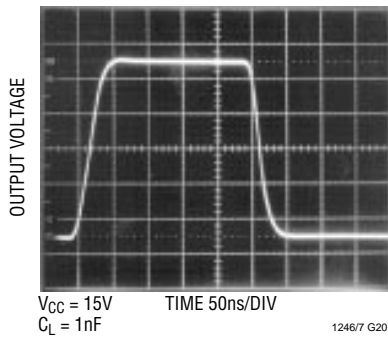

Current Sense Delay

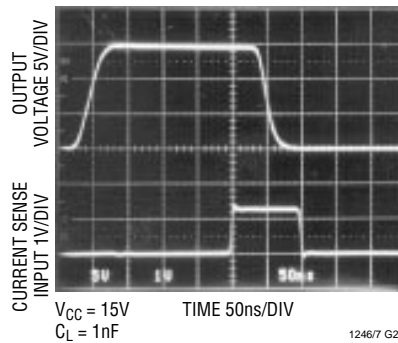

Output Cross-Conduction

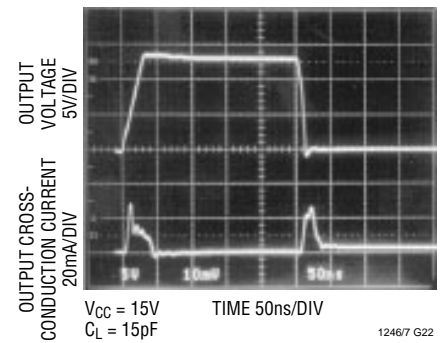

PIN FUNCTIONS

COMP (Pin 1): Compensation Pin. This pin is the output of the Error Amplifier and is made available for loop compensation. It can also be used to adjust the maximum value of the current sense clamp voltage to less than 1V. This pin can source a minimum of 0.5mA (0.8mA typ.) and sink a minimum of 2mA (4mA typ.).

FB (Pin 2): Voltage Feedback. This pin is the inverting input of the Error Amplifier. The output voltage is normally fed back to this pin through a resistive divider. The noninverting input of the Error Amplifier is internally committed to a 2.5V reference point.

ISENSE (Pin 3): Current Sense. This is the input to the current sense comparator. The trip point of the comparator is set by, and is proportional to, the output voltage of the Error Amplifier.

R_T/C_T (Pin 4): The oscillator frequency and the deadtime are set by connecting a resistor (R_T) from V_{REF} to R_T/C_T and a capacitor (C_T) from R_T/C_T to GND.

The rise time of the oscillator waveform is set by the RC time constant of R_T and C_T . The fall time, which is equal to the output deadtime, is set by a combination of the RC time constant and the oscillator sink current (8.2mA typ.).

PIN FUNCTIONS

GND (Pin 5): Ground.

OUTPUT (Pin 6): Current Output. This pin is the output of a high current totem pole output stage. It is capable of driving up to $\pm 1A$ of current into a capacitive load such as the gate of a MOSFET.

V_{CC} (Pin 7): Supply Voltage. This pin is the positive supply of the control IC.

V_{REF} (Pin 8): Reference. This is the reference output of the IC. The reference output is used to supply charging current to the external timing resistor R_T . The reference provides biasing to a large portion of the internal circuitry, and is used to generate several internal reference levels including the V_{FB} level and the current sense clamp voltage.

APPLICATIONS INFORMATION

Device	Start-Up Threshold	Minimum Operating Voltage	Maximum Duty Cycle	Replaces
LT1246	16V	10V	100%	UC1842
LT1247	8.4V	7.6V	100%	UC1843

Oscillator

The LT1246/LT1247 are fixed frequency current mode pulse width modulators. The oscillator frequency and the oscillator discharge current are both trimmed and tightly specified to minimize the variations in frequency and deadtime. The oscillator frequency is set by choosing a resistor and capacitor combination, R_T and C_T . This RC combination will determine both the frequency and the maximum duty cycle. The resistor R_T is connected from V_{REF} (pin 8) to the R_T/C_T pin (pin 4). The capacitor C_T is connected from the R_T/C_T pin to ground. The charging current for C_T is determined by the value of R_T . The discharge current for C_T is set by the difference between the current supplied by R_T and the discharge current of the LT1246/LT1247. The discharge current of the device is trimmed to 8.2mA. For large values of R_T discharge time will be determined by the discharge current of the device and the value of C_T . As the value of R_T is reduced it will have more effect on the discharge time of C_T . During an oscillator cycle capacitor C_T is charged to approximately 2.8V and discharged to approximately 1.1V. The output is enabled during the charge time of C_T and disabled, in an off state, during the discharge time of C_T . The deadtime of the circuit is equal to the discharge time of C_T . The maximum duty cycle is limited by controlling the deadtime of the oscillator. There are many combinations of R_T and C_T that will yield a given oscillator frequency, however there is only one combination that will yield a specific

deadtime at that frequency. Curves of oscillator frequency and deadtime for various values of R_T and C_T appear in the Typical Performance Characteristics section. Frequency and deadtime can also be calculated using the following formulas:

$$\text{Oscillator Rise Time: } t_r = 0.583 \cdot RC$$

$$\text{Oscillator Discharge Time: } t_d = \frac{3.46 \cdot RC}{0.0164R - 11.73}$$

$$\text{Oscillator Period: } t_{OSC} = t_r + t_d$$

$$\text{Oscillator Frequency: } f_{OSC} = \frac{1}{t_{OSC}}$$

$$\text{Maximum Duty Cycle: } D_{MAX} = \frac{t_r}{t_{OSC}} = \frac{t_{OSC} - t_d}{t_{OSC}}$$

The above formulas will give values that will be accurate to approximately $\pm 5\%$, at the oscillator, over the full operating frequency range. This is due to the fact that the oscillator trip levels are constant versus frequency and the discharge current and initial oscillator frequency are trimmed. Some fine adjustment may be required to achieve more accurate results. Once the final R_T/C_T combination is selected, the oscillator characteristics will be repeatable from device to device. Note that there will be some slight differences between maximum duty cycle at the oscillator and maximum duty cycle at the output due to the finite rise and fall times of the output.

Error Amplifier

The LT1246/LT1247 contain a fully compensated error amplifier with a DC gain of 90dB and a unity-gain frequency of 2MHz. Phase margin at unity-gain is 80°. The noninverting input is internally committed to a 2.5V reference point derived from the 5V reference of pin 8. The

APPLICATIONS INFORMATION

inverting input (pin 2) and the output (pin 1) are made available to the user. The output voltage in a regulator circuit is normally fed back to the inverting input of the error amplifier through a resistive divider. The output of the error amplifier is made available for external loop compensation. The output current of the error amplifier is limited to approximately 0.8mA sourcing and approximately 6mA sinking.

In a current mode PWM the peak switch current is a function of the output voltage of the error amplifier. In the LT1246/LT1247 the output of the error amplifier is offset by two diodes (1.4V at 25°C), divided by a factor of three, and fed to the inverting input of the current sense comparator. For output voltages less than 1.4V the duty cycle of the output stage will be zero. The maximum offset that can appear at the current sense input is limited by a 1V clamp. This occurs when the error amplifier output reaches 4.4V at 25°C. The output of the error amplifier can be clamped below 4.4V in order to reduce the maximum voltage allowed across the current sensing resistor to less than 1V. The supply current will increase by the value of the output source current when the output voltage of the error amplifier is clamped.

Current Sense Comparator and PWM Latch

LT1246/LT1247 are current mode controllers. Under normal operating conditions the output (pin 6) is turned on at the start of every oscillator cycle, coincident with the rising edge of the oscillator waveform. The output is then turned off when the switch current reaches a threshold level proportional to the error voltage at the output of the error amplifier. Once the output is turned off it is latched off until the start of the next cycle. The peak switch current is thus proportional to the error voltage and is controlled on a cycle by cycle basis. The peak switch current is normally sensed by placing a sense resistor in the source lead of the output MOSFET. This resistor converts the switch current to a voltage that can be fed into the current sense input. For normal operating conditions the peak inductor current, which is equal to the peak switch current, will be equal to:

$$I_{PK} = \frac{(V_{PIN1} - 1.4V)}{(3R_S)}$$

During fault conditions the maximum threshold voltage at the input of the current sense comparator is limited by the internal 1V clamp at the inverting input. The peak switch current will be equal to:

$$I_{PK(MAX)} = \frac{1.0V}{R_S}$$

In certain applications such as high power regulators it may be desirable to limit the maximum threshold voltage to less than 1V in order to limit the power dissipated in the sense resistor or to limit the short-circuit current of the regulator circuit. This can be accomplished by clamping the output of the error amplifier. A voltage level of approximately 1.4V at the error amplifier output will give a threshold voltage of 0V. A voltage level of approximately 4.4V at the output of the error amplifier will give a threshold level of 1V. Between 1.4V and 4.4V the threshold voltage will change by a factor of one third of the change in the error amplifier output voltage. The threshold voltage will be 0.333V for an error amplifier voltage of 2.4V. To reduce the maximum current sense threshold to less than 1V the error amplifier output should be clamped to less than 4.4V.

Blanking

A unique feature of the LT1246/LT1247 is the built-in blanking circuit at the output of the current sense comparator. A common problem with current mode PWM circuits is erratic operation due to noise at the current sense input. The primary cause of noise problems is the leading edge current spike due to transformer interwinding capacitance and diode reverse recovery time. This current spike can prematurely trip the current sense comparator causing an instability in the regulator circuit. A filter at the current sense input is normally required to eliminate this instability. This filter will in turn slow down the current sense loop. A slow current sense loop will increase the minimum pulse width which will increase the short-circuit current in an overload condition. The LT1246/LT1247 blank (lock out) the signal at the output of the current sense comparator for a fixed amount of time after the switch is turned on. This prevents the PWM latch from tripping due to the leading edge current spike. The blanking time will be a function of the voltage at the feedback pin (pin 2). The blanking time will be 60ns for normal operat-

APPLICATIONS INFORMATION

ing conditions ($V_{FB} = 2.5V$). The blanking time goes to zero as the feedback pin is pulled to 0V. This means that the blanking time will be minimized during start-up and also during an output short-circuit fault. This blanking circuit eliminates the need for an input filter at the current sense input except in extreme cases. Eliminating the filter allows the current sense loop to operate with minimum delays, reducing peak currents during fault conditions.

Undervoltage Lockout

The LT1246/LT1247 incorporate an undervoltage lockout comparator which prevents the internal reference circuitry and the output from starting up until the supply voltage reaches the start-up threshold voltage. The quiescent current, below the start-up threshold, has been reduced to less than 250 μ A (170 μ A typ.). This minimizes the power loss due to the start-up resistor used in off-line converters. In undervoltage lockout both V_{REF} (pin 8) and the Output (pin 6) are actively pulled low by Darlington connected PNP transistors. They are designed to sink a few milliamps of current and will pull down to about 1V. The pull-down transistor at the reference pin can be used to reset the external soft start capacitor. The pull-down transistor at the output eliminates the external pull-down resistor required, with earlier devices, to hold the external MOSFET gate low during undervoltage lockout.

Output

The LT1246/LT1247 incorporate a single high current totem pole output stage. This output stage is capable of driving up to $\pm 1A$ of output current. Cross-conduction current spikes in the output totem pole have been eliminated. These devices are primarily intended for driving MOSFET switches. Rise time is typically 30ns and fall time is typically 20ns when driving a 1.0nF load. A clamp is built into the device to prevent the output from rising above 18V in order to protect the gate of the MOSFET switch. The output is actively pulled low during undervoltage lockout by a Darlington PNP. This PNP is designed to sink several milliamps and will pull the output down to approximately 1V. This active pull-down eliminates the need for the external resistor which was required in older designs.

The output pin of the device connects directly to the emitter of the upper NPN drive transistor and the collector of the lower NPN drive transistor in the totem pole. The

collector of the lower transistor, which is n-type silicon, forms a p-n junction with the substrate of the device. The substrate of the device is tied to ground. This junction is reverse biased during normal operation. In some applications the parasitic LC of the external MOSFET gate can ring and pull the output pin below ground. If the output pin is pulled negative by more than a diode drop, the parasitic diode formed by the collector of the output NPN and the substrate will turn on. This can cause erratic operation of the device. In these cases a Schottky clamp diode is recommended from output to ground.

Reference

The internal reference of the LT1246/LT1247 is a 5V Bandgap reference, trimmed to within $\pm 1\%$ initial tolerance. The reference is used to power the majority of the internal logic and the oscillator circuitry. The oscillator charging current is supplied from the reference. The feedback pin voltage and the clamp level for the current sense comparator are derived from the reference voltage. The reference can supply up to 20mA of current to power external circuitry. Note that using the reference in this manner, as a voltage regulator, will significantly increase the power dissipation in the device, which will reduce the operating ambient temperature range.

Design/Layout Considerations

LT1246/LT1247 are high speed circuits capable of generating pulsed output drive currents of up to 1A peak. The rise and fall time for the output drive current is in the range of 10ns to 20ns. High Speed circuit layout techniques must be used to insure proper operation of the devices. **Do not attempt to use Proto-boards or wire-wrap techniques to breadboard high speed switching regulator circuits. They will not work properly.**

Printed circuit layouts should include separate ground paths for the voltage feedback network, oscillator capacitor, and switch drive current. These ground paths should be connected together directly at the ground pin (pin 5) of the LT1246/LT1247. This will minimize noise problems due to pulsed ground pin currents. V_{CC} should be bypassed, with a minimum of 0.1 μ F, as close to the device as possible. High current paths should be kept short and they should be separated from the feedback voltage network with shield traces if possible.

TYPICAL APPLICATIONS

External Clock Synchronization

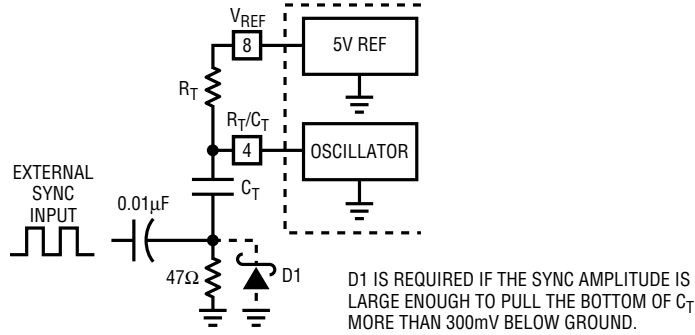

LT1246 • TA05

Soft Start

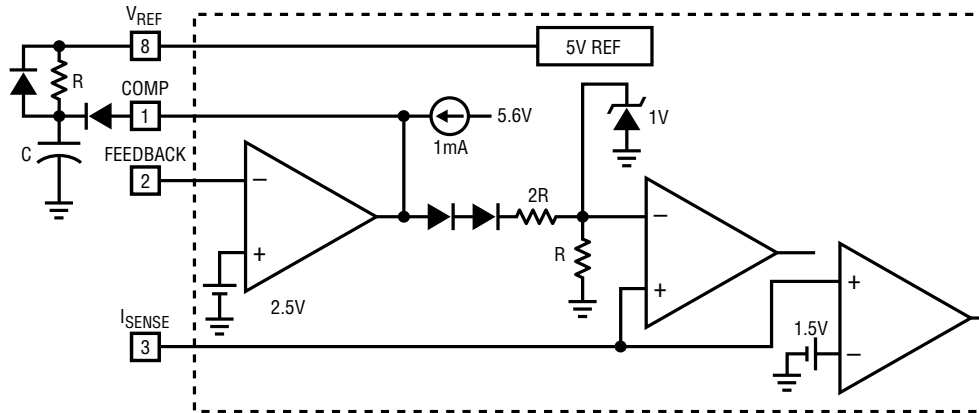

LT1246 • TA06

Adjustable Clamp Level with Soft Start

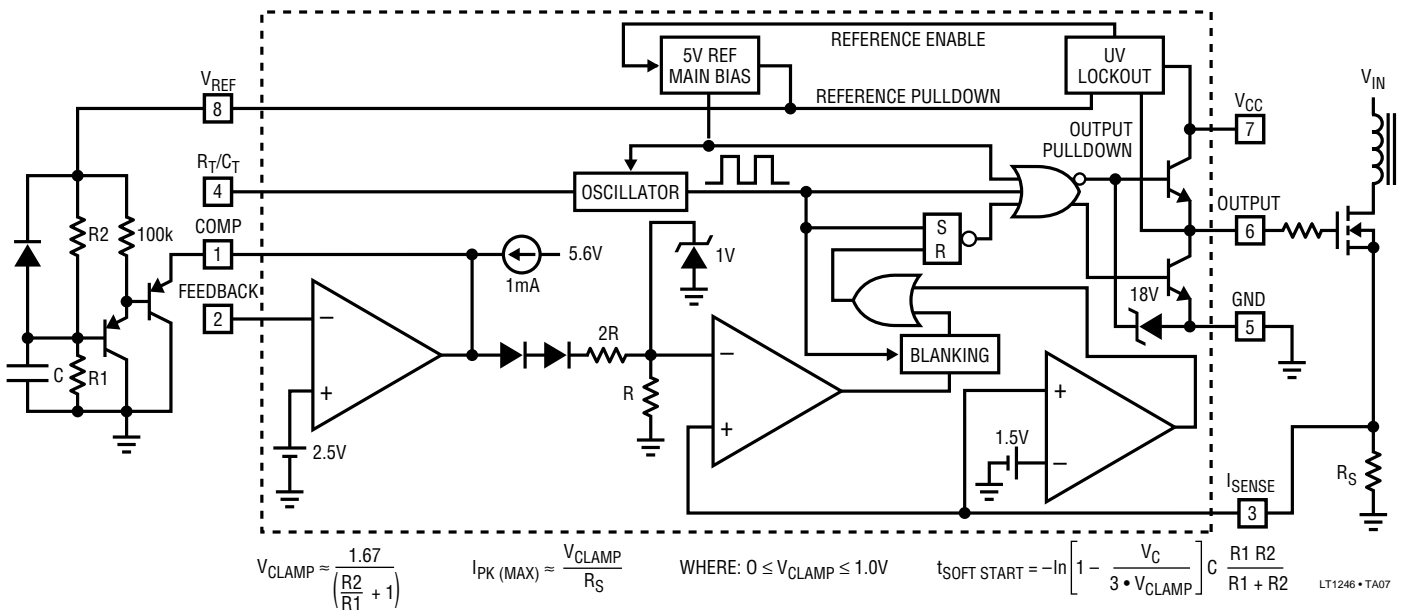

LT1246 • TA07

LT1246/LT1247

PACKAGE DESCRIPTION Dimensions in inches (millimeters) unless otherwise noted.

N8 Package 8-Lead Plastic DIP

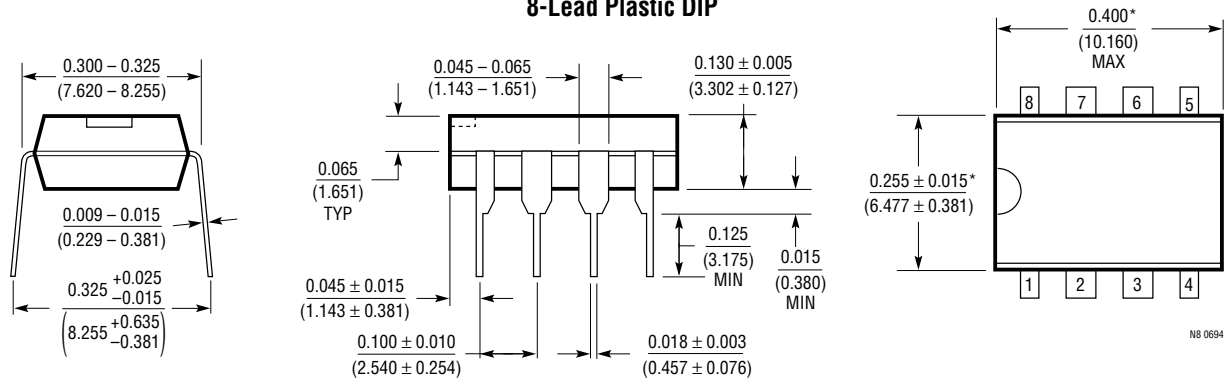

*THESE DIMENSIONS DO NOT INCLUDE MOLD FLASH OR PROTRUSIONS.
MOLD FLASH OR PROTRUSIONS SHALL NOT EXCEED 0.010 INCH (0.254mm).

S8 Package 8-Lead Plastic SOIC

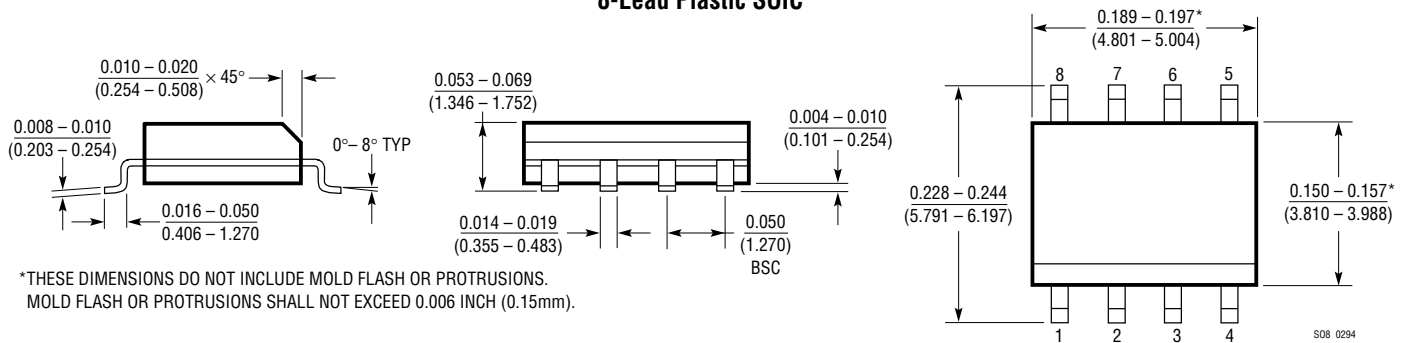

*THESE DIMENSIONS DO NOT INCLUDE MOLD FLASH OR PROTRUSIONS.
MOLD FLASH OR PROTRUSIONS SHALL NOT EXCEED 0.006 INCH (0.15mm).

RELATED PARTS

PART NUMBER	DESCRIPTION
LT1105	Off-Line Switching Regulator Controller
LT1170/LT1171/LT1172	High Efficiency 100kHz Switching Regulators
LT1241-5	500kHz Low Power Current Mode Pulse Width Modulator
LT1248/LT1249	Power Factor Controllers
LT1372	High Efficiency 500kHz Boost Switching Regulator
LT1376	1.5A, 500kHz Step-Down Switching Regulator
LT1377	1MHz High Efficiency Boost Switching Regulator
LT1431	Programmable Reference