

## FEATURES

- 0.4V Dropout Voltage
- 150mA Output Current
- 30 $\mu$ A Quiescent Current
- No Protection Diodes Needed
- Adjustable Output from 3.8V to 20V
- 3.3V and 5V Fixed Output Voltages
- Controlled Quiescent Current in Dropout
- Shutdown
- 16 $\mu$ A Quiescent Current in Shutdown
- Stable with 0.33 $\mu$ F Output Capacitor
- Reverse Battery Protection
- No Reverse Current with Input Low
- Thermal Limiting

## APPLICATIONS

- Low Current Regulator
- Regulator for Battery-Powered Systems
- Post Regulator for Switching Supplies

## DESCRIPTION

The LT1121/LT1121-3.3/LT1121-5 are micropower low dropout regulators with shutdown. These devices are capable of supplying 150mA of output current with a dropout voltage of 0.4V. Designed for use in battery-powered systems, the low quiescent current, 30 $\mu$ A operating and 16 $\mu$ A in shutdown, makes them an ideal choice. The quiescent current is well-controlled; it does not rise in dropout as it does with many other low dropout PNP regulators.

Other features of the LT1121/LT1121-3.3/LT1121-5 include the ability to operate with very small output capacitors. They are stable with only 0.33 $\mu$ F on the output while most older devices require between 1 $\mu$ F and 100 $\mu$ F for stability. Small ceramic capacitors can be used, enhancing manufacturability. Also the input may be connected to ground or a reverse voltage without reverse current flow from output to input. This makes the LT1121 series ideal for backup power situations where the output is held high and the input is at ground or reversed. Under these conditions only 16 $\mu$ A will flow from the output pin to ground.

## TYPICAL APPLICATION

5V Battery-Powered Supply with Shutdown

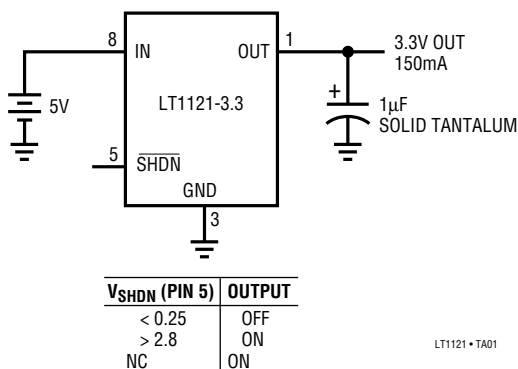

Dropout Voltage

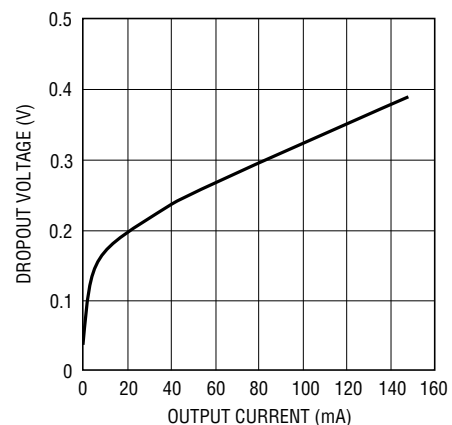

# LT1121/LT1121-3.3/LT1121-5

## ABSOLUTE MAXIMUM RATINGS

Input Voltage .....  $\pm 30V^*$   
 Output Pin Reverse Current ..... 10mA  
 Adjust Pin Current ..... 10mA  
 Shutdown Pin Input Voltage (Note 1) ..... 6.5V, -0.6V  
 Shutdown Pin Input Current (Note 1) ..... 20mA  
 Output Short-Circuit Duration ..... Indefinite

Storage Temperature Range .....  $-65^{\circ}\text{C}$  to  $150^{\circ}\text{C}$   
 Operating Junction Temperature Range (Note 2)  
 LT1121C-X .....  $0^{\circ}\text{C}$  to  $125^{\circ}\text{C}$   
 LT1121I-X .....  $-40^{\circ}\text{C}$  to  $125^{\circ}\text{C}$   
 Lead Temperature (Soldering, 10 sec) .....  $300^{\circ}\text{C}$

\*For applications requiring input voltage ratings greater than 30V, contact the factory.

## PACKAGE/ORDER INFORMATION

<p>N8 PACKAGE 8-LEAD PLASTIC DIP</p> <p>S8 PACKAGE 8-LEAD PLASTIC SOIC</p> <p><math>\theta_{JA} = 120^{\circ}\text{C/W}</math> (N8, S8)  <math>\theta_{JA} = 70^{\circ}\text{C/W}</math> (AS8)</p>		<p>*PIN 2 = NC FOR LT1121-3.3/LT1121-5 = ADJ FOR LT1121</p> <p>**PINS 6 AND 7 ARE FLOATING (NO INTERNAL CONNECTION) ON THE STANDARD S8 PACKAGE. PINS 6 AND 7 CONNECTED TO GROUND ON THE A VERSION OF THE LT1121 (S8 ONLY). CONNECTING PINS 6 AND 7 TO THE GROUND PLANE WILL REDUCE THERMAL RESISTANCE. SEE THERMAL RESISTANCE TABLES IN THE APPLICATIONS INFORMATION SECTION.</p>		<p>ST PACKAGE 3-LEAD PLASTIC SOT-223</p> <p>LT1121 • P003</p> <p><math>\theta_{JA} = 50^{\circ}\text{C/W}</math></p>		<p>Z PACKAGE 3-LEAD PLASTIC TO-92</p> <p>LT1121 • P002</p> <p><math>\theta_{JA} = 150^{\circ}\text{C/W}</math></p>	
ORDER PART NUMBER		S8 PART MARKING		ORDER PART NUMBER		ORDER PART NUMBER	
LT1121CN8	LT1121IS8	1121	1121A	LT1121CST-3.3	LT1121CZ-3.3		
LT1121CN8-3.3	LT1121IS8-3.3	11213	121A3	LT1121IST-3.3	LT1121IZ-3.3		
LT1121CN8-5	LT1121IS8-5	11215	121A5	LT1121CST-5	LT1121CZ-5		
LT1121IN8	LT1121ACS8	1121I	121AI	LT1121IST-5	LT1121IZ-5		
LT1121IN8-3.3	LT1121ACS8-3.3	121I3	121AI3				
LT1121IN8-5	LT1121ACS8-5	121I5	121AI5				
LT1121CS8	LT1121AIS8						
LT1121CS8-3.3	LT1121AIS8-3.3						
LT1121CS8-5	LT1121AIS8-5						

Consult factory for Military grade parts.

## ELECTRICAL CHARACTERISTICS

PARAMETER	CONDITIONS			MIN	TYP	MAX	UNITS
Regulated Output Voltage (Note 3)	LT1121-3.3	$V_{IN} = 3.8V, I_{OUT} = 1mA, T_J = 25^{\circ}\text{C}$	●	3.250	3.300	3.350	V
		$4.3V < V_{IN} < 20V, 1mA < I_{OUT} < 150mA$	●	3.200	3.300	3.400	V
	LT1121-5	$V_{IN} = 5.5V, I_{OUT} = 1mA, T_J = 25^{\circ}\text{C}$	●	4.925	5.000	5.075	V
		$6V < V_{IN} < 20V, 1mA < I_{OUT} < 150mA$	●	4.850	5.000	5.150	V
Line Regulation	LT1121-3.3	$V_{IN} = 4.3V, I_{OUT} = 1mA, T_J = 25^{\circ}\text{C}$	●	3.695	3.750	3.805	V
		$4.8V < V_{IN} < 20V, 1mA < I_{OUT} < 150mA$	●	3.640	3.750	3.860	V
	LT1121 (Note 4)	$\Delta V_{IN} = 4.8V \text{ to } 20V, I_{OUT} = 1mA$	●		1.5	10	mV
	LT1121-5	$\Delta V_{IN} = 5.5V \text{ to } 20V, I_{OUT} = 1mA$	●		1.5	10	mV
	LT1121 (Note 4)	$\Delta V_{IN} = 4.3V \text{ to } 20V, I_{OUT} = 1mA$	●		1.5	10	mV

## ELECTRICAL CHARACTERISTICS

PARAMETER	CONDITIONS	MIN	TYP	MAX	UNITS
Load Regulation	LT1121-3.3 $\Delta I_{LOAD} = 1\text{mA to }150\text{mA}$ , $T_J = 25^\circ\text{C}$ $\Delta I_{LOAD} = 1\text{mA to }150\text{mA}$	●	-12 -20	-20 -30	mV mV
	LT1121-5 $\Delta I_{LOAD} = 1\text{mA to }150\text{mA}$ , $T_J = 25^\circ\text{C}$ $\Delta I_{LOAD} = 1\text{mA to }150\text{mA}$	●	-17 -28	-30 -45	mV mV
	LT1121 (Note 4) $\Delta I_{LOAD} = 1\text{mA to }150\text{mA}$ , $T_J = 25^\circ\text{C}$ $\Delta I_{LOAD} = 1\text{mA to }150\text{mA}$	●	-12 -18	-20 -30	mV mV
Dropout Voltage (Note 5)	$I_{LOAD} = 1\text{mA}$ , $T_J = 25^\circ\text{C}$ $I_{LOAD} = 1\text{mA}$	●	0.13	0.16 0.25	V V
	$I_{LOAD} = 50\text{mA}$ , $T_J = 25^\circ\text{C}$ $I_{LOAD} = 50\text{mA}$	●	0.30	0.35 0.50	V V
	$I_{LOAD} = 100\text{mA}$ , $T_J = 25^\circ\text{C}$ $I_{LOAD} = 100\text{mA}$	●	0.37	0.45 0.60	V V
	$I_{LOAD} = 150\text{mA}$ , $T_J = 25^\circ\text{C}$ $I_{LOAD} = 150\text{mA}$	●	0.42	0.55 0.70	V V
Ground Pin Current (Note 6)	$I_{LOAD} = 0\text{mA}$	●	30	50	$\mu\text{A}$
	$I_{LOAD} = 1\text{mA}$	●	90	120	$\mu\text{A}$
	$I_{LOAD} = 10\text{mA}$	●	350	500	$\mu\text{A}$
	$I_{LOAD} = 50\text{mA}$	●	1.5	2.5	mA
	$I_{LOAD} = 100\text{mA}$	●	4.0	7.0	mA
	$I_{LOAD} = 150\text{mA}$	●	7.0	14.0	mA
Adjust Pin Bias Current (Notes 4, 7)	$T_J = 25^\circ\text{C}$		150	300	nA
Shutdown Threshold	$V_{OUT} = \text{Off to On}$	●		1.2	V
	$V_{OUT} = \text{On to Off}$	●	0.25	0.75	V
Shutdown Pin Current (Note 8)	$V_{SHDN} = 0\text{V}$	●	6	10	$\mu\text{A}$
Quiescent Current in Shutdown (Note 9)	$V_{IN} = 6\text{V}$ , $V_{SHDN} = 0\text{V}$	●	15	22	$\mu\text{A}$
Ripple Rejection	$V_{IN} - V_{OUT} = 1\text{V (Avg)}$ , $V_{RIPPLE} = 0.5\text{V}_{P-P}$ , $f_{RIPPLE} = 120\text{Hz}$ , $I_{LOAD} = 0.1\text{A}$		50	58	dB
Current Limit	$V_{IN} - V_{OUT} = 7\text{V}$ , $T_J = 25^\circ\text{C}$		200	500	mA
Input Reverse Leakage Current	$V_{IN} = -20\text{V}$ , $V_{OUT} = 0\text{V}$	●		1.0	mA
Reverse Output Current (Note 10)	LT1121-3.3 $V_{OUT} = 3.3\text{V}$ , $V_{IN} = 0\text{V}$		16	25	$\mu\text{A}$
	LT1121-5 $V_{OUT} = 5\text{V}$ , $V_{IN} = 0\text{V}$		16	25	$\mu\text{A}$
	LT1121 (Note 4) $V_{OUT} = 3.8\text{V}$ , $V_{IN} = 0\text{V}$		16	25	$\mu\text{A}$

The ● denotes specifications which apply over the operating temperature range.

**Note 1:** The Shutdown pin input voltage rating is required for a low impedance source. Internal protection devices connected to the shutdown pin will turn on and clamp the pin to approximately 7V or -0.6V. This range allows the use of 5V logic devices to drive the pin directly. For high impedance sources or logic running on supply voltages greater than 5.5V, the maximum current driven into the shutdown pin must be limited to less than 20mA.

**Note 2:** For junction temperatures greater than 110°C, a minimum load of 1mA is recommended. For  $T_J > 110^\circ\text{C}$  and  $I_{OUT} < 1\text{mA}$ , output voltage may increase by 1%.

**Note 3:** Operating conditions are limited by maximum junction temperature. The regulated output voltage specification will not apply for all possible combinations of input voltage and output current. When operating at maximum input voltage, the output current range must be limited. When operating at maximum output current the input voltage range must be limited.

**Note 4:** The LT1121 (adjustable version) is tested and specified with the adjust pin connected to the output pin.

**Note 5:** Dropout voltage is the minimum input/output voltage required to maintain regulation at the specified output current. In dropout the output voltage will be equal to:  $(V_{IN} - V_{DROPOUT})$ .

**Note 6:** Ground pin current is tested with  $V_{IN} = V_{OUT}$  (nominal) and a current source load. This means that the device is tested while operating in its dropout region. This is the worst case ground pin current. The ground pin current will decrease slightly at higher input voltages.

**Note 7:** Adjust pin bias current flows into the adjust pin.

**Note 8:** Shutdown pin current at  $V_{SHDN} = 0\text{V}$  flows out of the shutdown pin.

**Note 9:** Quiescent current in shutdown is equal to the sum total of the shutdown pin current (6 $\mu\text{A}$ ) and the ground pin current (9 $\mu\text{A}$ ).

**Note 10:** Reverse output current is tested with the input pin grounded and the output pin forced to the rated output voltage. This current flows into the output pin and out of the ground pin.

## TYPICAL PERFORMANCE CHARACTERISTICS

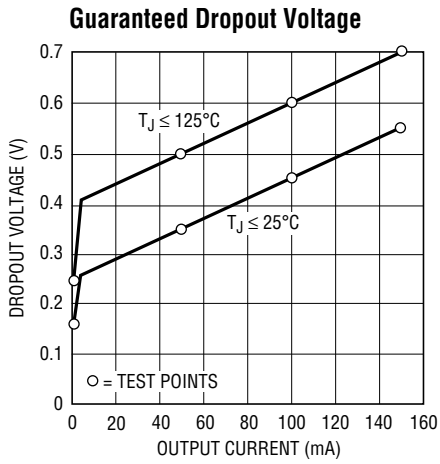

1121 G27

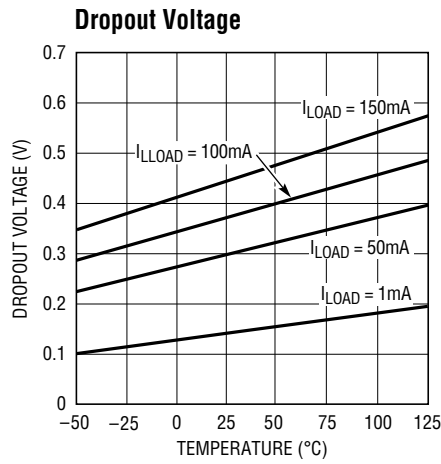

1121 G14

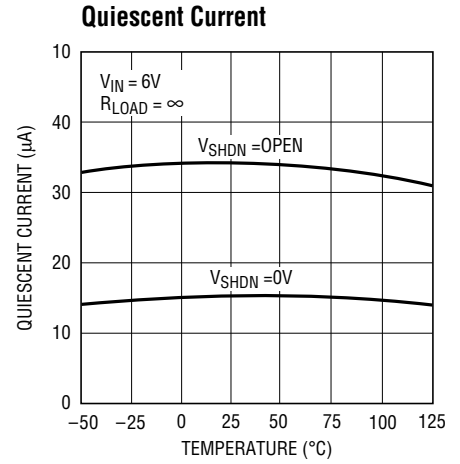

1121 G11

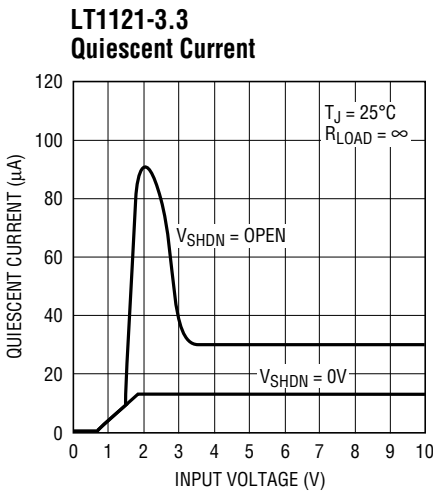

1121 G04

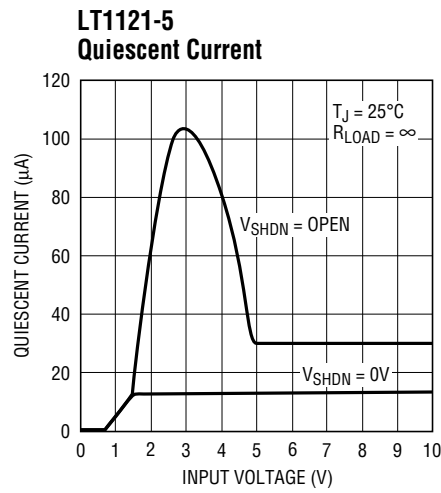

1121 G02

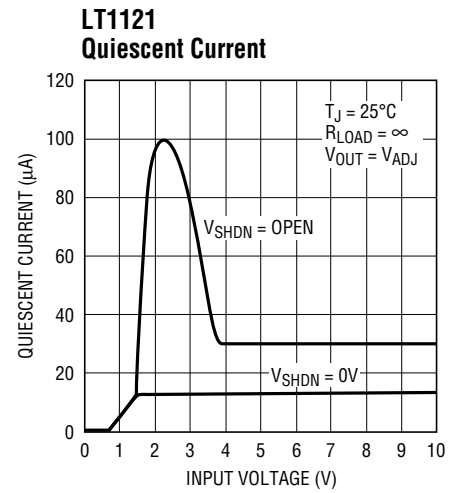

1121 G03

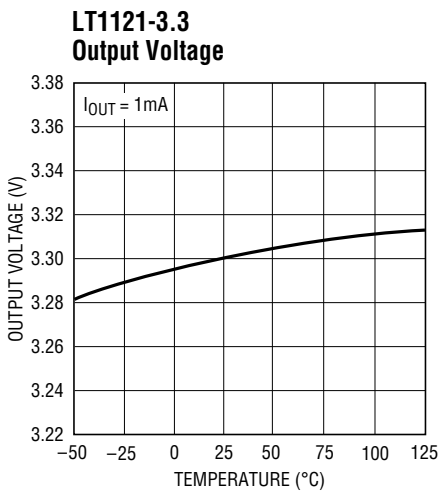

1121 G22

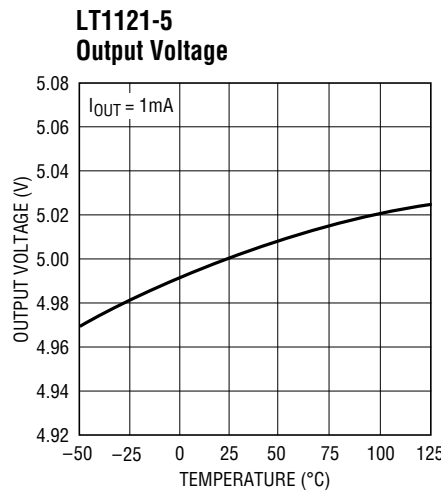

1121 G23

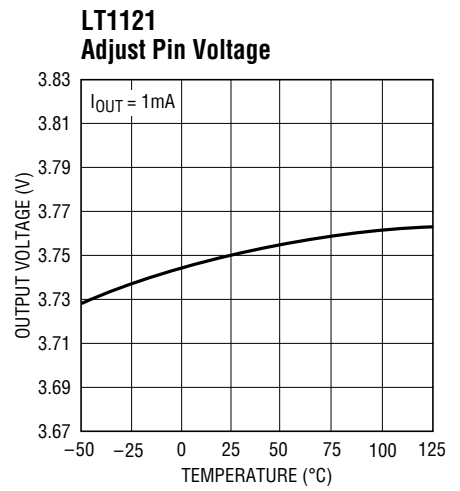

1121 G24

# TYPICAL PERFORMANCE CHARACTERISTICS

**LT1121-3.3  
Ground Pin Current**

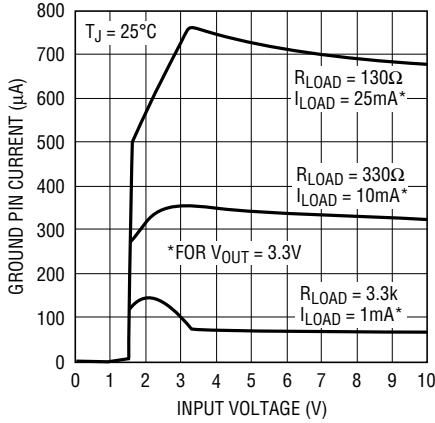

1121 G10

**LT1121-5  
Ground Pin Current**

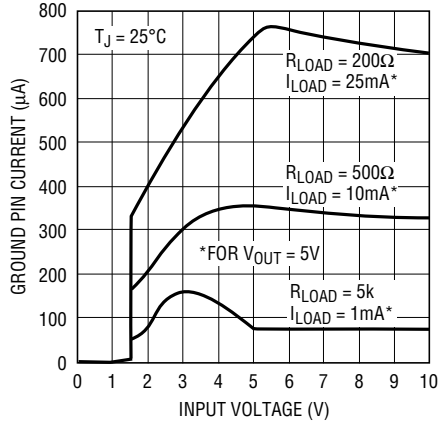

1121 G06

**LT1121  
Ground Pin Current**

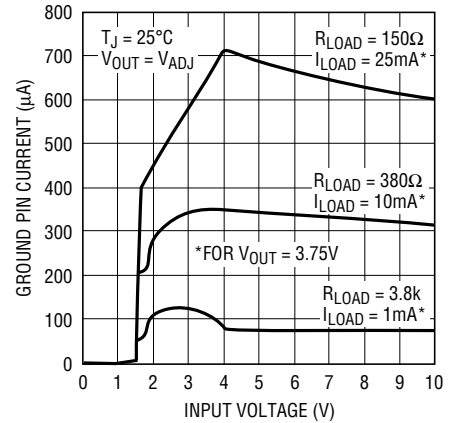

1121 G08

**LT1121-3.3  
Ground Pin Current**

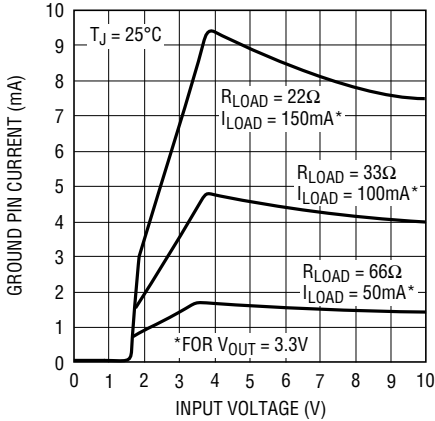

1121 G09

**LT1121-5  
Ground Pin Current**

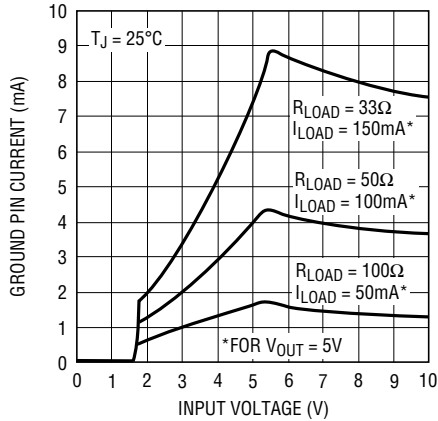

1121 G05

**LT1121  
Ground Pin Current**

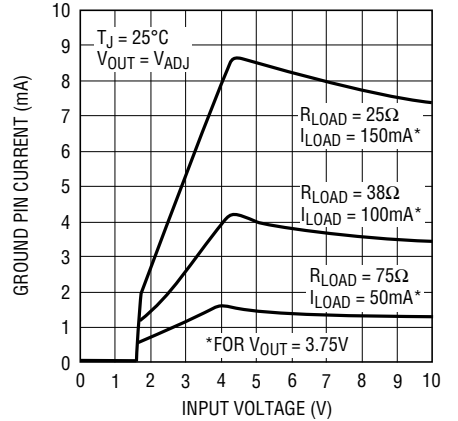

1121 G07

**Ground Pin Current**

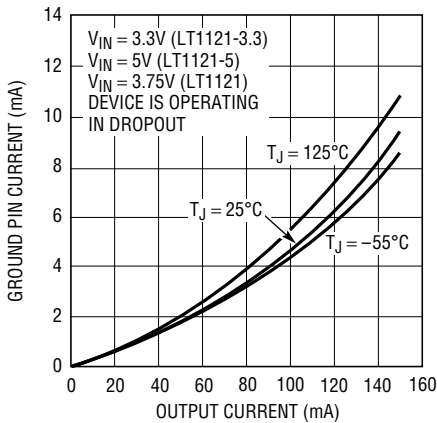

1121 G29

**Shutdown Pin Threshold  
(On-to-Off)**

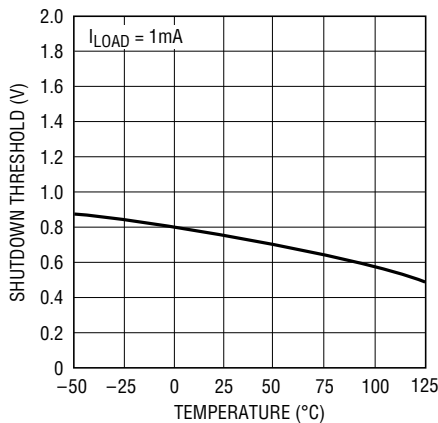

1121 G16

**Shutdown Pin Threshold  
(Off-to-On)**

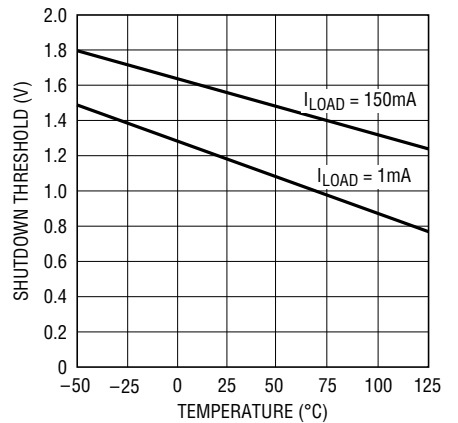

1121 G17

**TYPICAL PERFORMANCE CHARACTERISTICS**

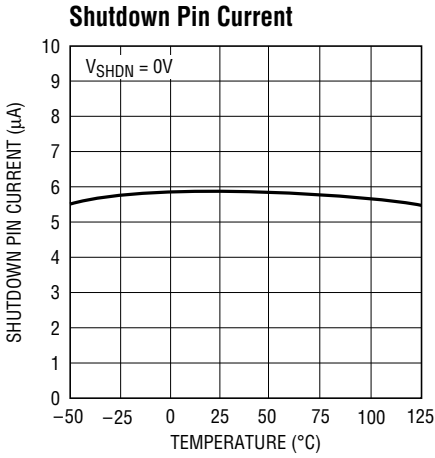

1121 G15

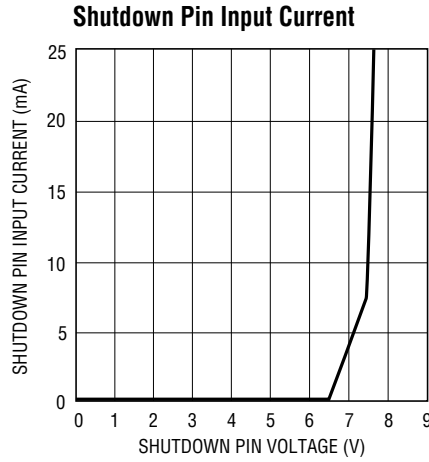

1121 G28

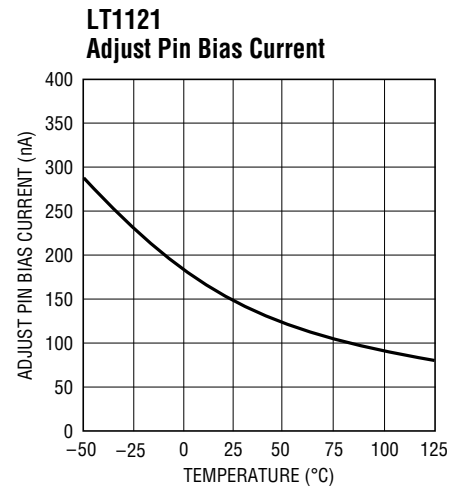

1121 G25

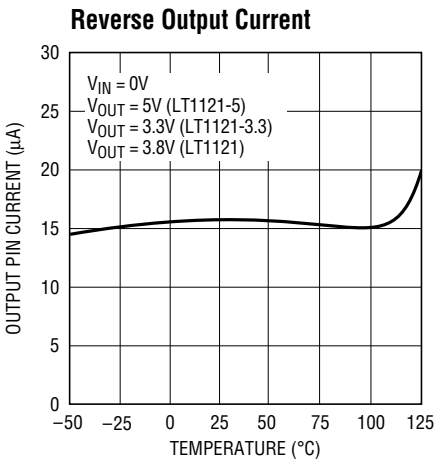

1121 G13

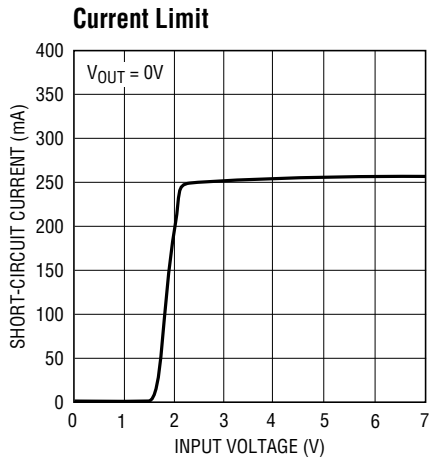

1121 G20

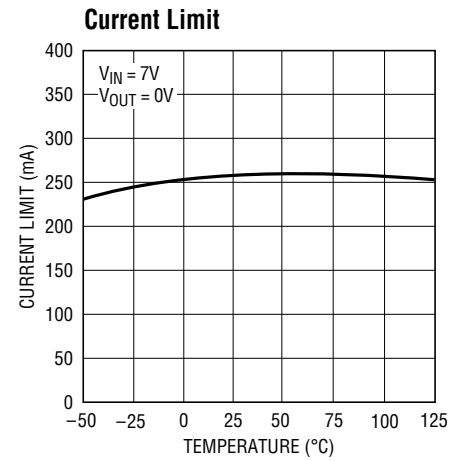

1121 G19

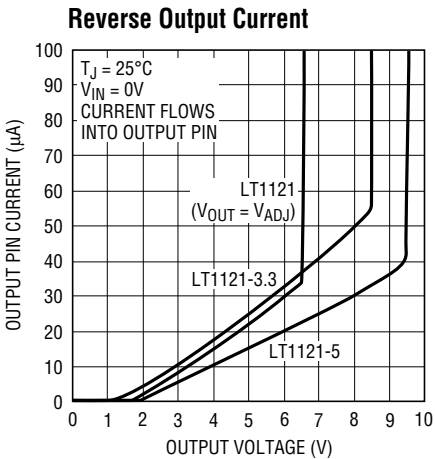

1121 G01

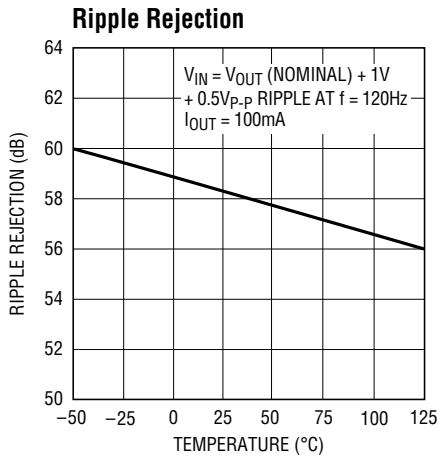

1121 G18

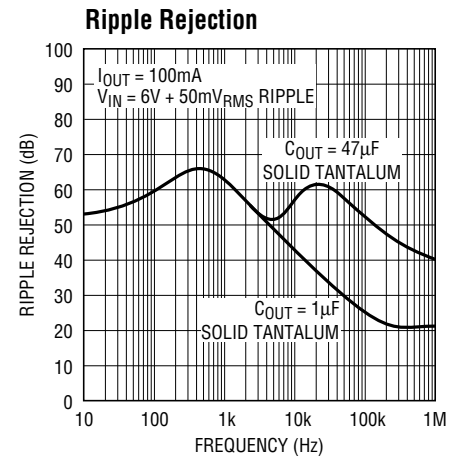

1121 G26

## TYPICAL PERFORMANCE CHARACTERISTICS

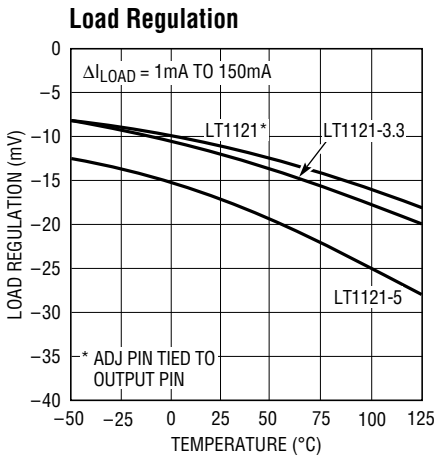

1121 G21

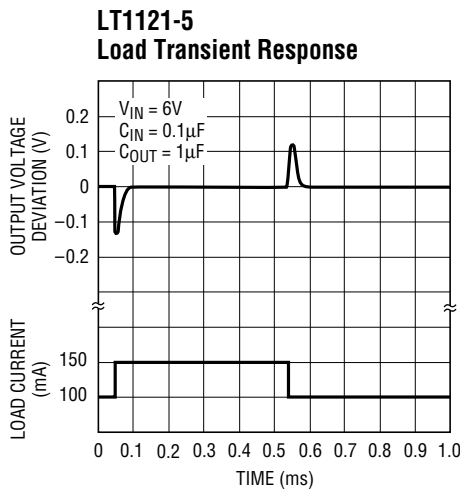

1121 G30

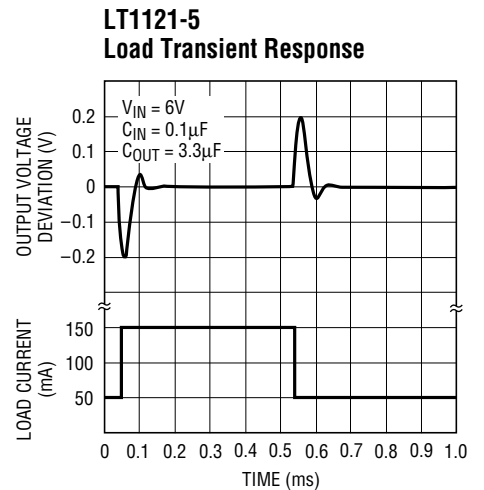

1121 G31

## PIN FUNCTIONS

**Input Pin:** Power is supplied to the device through the input pin. The input pin should be bypassed to ground if the device is more than 6 inches away from the main input filter capacitor. In general the output impedance of a battery rises with frequency so it is usually advisable to include a bypass capacitor in battery-powered circuits. A bypass capacitor in the range of 0.1µF to 1µF is sufficient. The LT1121 is designed to withstand reverse voltages on the input pin with respect to both ground and the output pin. In the case of a reversed input, which can happen if a battery is plugged in backwards, the LT1121 will act as if there is a diode in series with its input. There will be no reverse current flow into the LT1121 and no reverse voltage will appear at the load. The device will protect both itself and the load.

**Output Pin:** The output pin supplies power to the load. An output capacitor is required to prevent oscillations. See the Applications Information section for recommended value of output capacitance and information on reverse output characteristics.

**Shutdown Pin:** This pin is used to put the device into shutdown. In shutdown the output of the device is turned

off. This pin is active low. The device will be shut down if the shutdown pin is pulled low. The shutdown pin current with the pin pulled to ground will be 6µA. The shutdown pin is internally clamped to 7V and -0.6V (one  $V_{BE}$ ). This allows the shutdown pin to be driven directly by 5V logic or by open collector logic with a pull-up resistor. The pull-up resistor is only required to supply the leakage current of the open collector gate, normally several microamperes. Pull-up current must be limited to a maximum of 20mA. A curve of shutdown pin input current as a function of voltage appears in the Typical Performance Characteristics. If the shutdown pin is not used it can be left open circuit. The device will be active, output on, if the shutdown pin is not connected.

**Adjust Pin:** For the adjustable LT1121, the adjust pin is the input to the error amplifier. This pin is internally clamped to 6V and -0.6V (one  $V_{BE}$ ). It has a bias current of 150nA which flows into the pin. See Bias Current curve in the Typical Performance Characteristics. The adjust pin reference voltage is 3.75V referenced to ground. The output voltage range that can be produced by this device is 3.75V to 30V.

## APPLICATIONS INFORMATION

The LT1121 is a micropower low dropout regulator with shutdown, capable of supplying up to 150mA of output current at a dropout voltage of 0.4V. The device operates with very low quiescent current (30µA). In shutdown the quiescent current drops to only 16µA. In addition to the low quiescent current the LT1121 incorporates several protection features which make it ideal for use in battery-powered systems. The device is protected against both reverse input voltages and reverse output voltages. In battery backup applications where the output can be held up by a backup battery when the input is pulled to ground, the LT1121 acts like it has a diode in series with its output and prevents reverse current flow.

### Adjustable Operation

The adjustable version of the LT1121 has an output voltage range of 3.75V to 20V. The output voltage is set by the ratio of two external resistors as shown in Figure 1. The device servos the output voltage to maintain the voltage at the adjust pin at 3.75V. The current in R1 is then equal to 3.75V/R1. The current in R2 is equal to the sum of the current in R1 and the adjust pin bias current. The adjust pin bias current, 150nA at 25°C, flows through R2 into the adjust pin. The output voltage can be calculated according to the formula in Figure 1. The value of R1 should be less than 400k to minimize errors in the output voltage caused by the adjust pin bias current. Note that in shutdown the output is turned off and the divider current will be zero. Curves of Adjust Pin Voltage vs Temperature and Adjust Pin Bias Current vs Temperature appear in the Typical Performance Characteristics. The reference voltage at the adjust pin has a slight positive temperature coefficient of

approximately 15ppm/°C. The adjust pin bias current has a negative temperature coefficient. These effects are small and will tend to cancel each other.

The adjustable device is specified with the adjust pin tied to the output pin. This sets the output voltage to 3.75V. Specifications for output voltage greater than 3.75V will be proportional to the ratio of the desired output voltage to 3.75V ( $V_{OUT}/3.75V$ ). For example: load regulation for an output current change of 1mA to 150mA is -12mV typical at  $V_{OUT} = 3.75V$ . At  $V_{OUT} = 12V$ , load regulation would be:

$$\left( \frac{12V}{3.75V} \right) \times (-12mV) = (-38mV)$$

### Thermal Considerations

Power handling capability will be limited by maximum rated junction temperature (125°C). Power dissipated by the device will be made up of two components:

1. Output current multiplied by the input/output voltage differential:  $I_{OUT} \times (V_{IN} - V_{OUT})$ , and
2. Ground pin current multiplied by the input voltage:  $I_{GND} \times V_{IN}$ .

The ground pin current can be found by examining the Ground Pin Current curves in the Typical Performance Characteristics. Power dissipation will be equal to the sum of the two components listed above.

The LT1121 series regulators have internal thermal limiting designed to protect the device during overload conditions. For continuous normal load conditions the maximum junction temperature rating of 125°C must not be exceeded. It is important to give careful consideration to all sources of thermal resistance from junction to ambient. Additional heat sources mounted nearby must also be considered.

Heat sinking, for surface mount devices, is accomplished by using the heat spreading capabilities of the PC board and its copper traces. Copper board stiffeners and plated through holes can also be used to spread the heat generated by power devices. Tables 1 through 5 list thermal resistances for each package. Measured values of thermal resistance for several different board sizes and copper areas are listed for each package. All measurements were

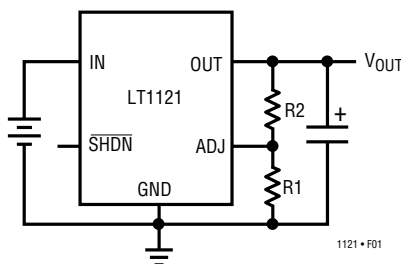

$$V_{OUT} = 3.75V \left( 1 + \frac{R2}{R1} \right) + (I_{ADJ} \cdot R2)$$

$V_{ADJ} = 3.75V$   
 $I_{ADJ} = 150nA \text{ AT } 25^\circ C$   
 OUTPUT RANGE = 3.75V TO 30V

Figure 1. Adjustable Operation



## APPLICATIONS INFORMATION

taken in still air, on 3/32" FR-4 board with 1oz copper. All NC leads were connected to the ground plane.

**Table 1. N8 Package\***

COPPER AREA		BOARD AREA	THERMAL RESISTANCE (JUNCTION-TO-AMBIENT)
TOPSIDE	BACKSIDE		
2500 sq. mm	2500 sq. mm	2500 sq. mm	80°C/W
1000 sq. mm	2500 sq. mm	2500 sq. mm	80°C/W
225 sq. mm	2500 sq. mm	2500 sq. mm	85°C/W
1000 sq. mm	1000 sq. mm	1000 sq. mm	91°C/W

\* Device is mounted on topside. Leads are through hole and are soldered to both sides of board.

**Table 2. S8 Package**

COPPER AREA		BOARD AREA	THERMAL RESISTANCE (JUNCTION-TO-AMBIENT)
TOPSIDE*	BACKSIDE		
2500 sq. mm	2500 sq. mm	2500 sq. mm	120°C/W
1000 sq. mm	2500 sq. mm	2500 sq. mm	120°C/W
225 sq. mm	2500 sq. mm	2500 sq. mm	25°C/W
100 sq. mm	1000 sq. mm	1000 sq. mm	131°C/W

\* Device is mounted on topside.

**Table 3. AS8 Package\***

COPPER AREA		BOARD AREA	THERMAL RESISTANCE (JUNCTION-TO-AMBIENT)
TOPSIDE**	BACKSIDE		
2500 sq. mm	2500 sq. mm	2500 sq. mm	60°C/W
1000 sq. mm	2500 sq. mm	2500 sq. mm	60°C/W
225 sq. mm	2500 sq. mm	2500 sq. mm	68°C/W
100 sq. mm	2500 sq. mm	2500 sq. mm	74°C/W

\* Pins 3, 6, and 7 are ground.

\*\* Device is mounted on topside.

**Table 4. SOT-223 Package (Thermal Resistance Junction-to-Tab 20°C/W)**

COPPER AREA		BOARD AREA	THERMAL RESISTANCE (JUNCTION-TO-AMBIENT)
TOPSIDE*	BACKSIDE		
2500 sq. mm	2500 sq. mm	2500 sq. mm	50°C/W
1000 sq. mm	2500 sq. mm	2500 sq. mm	50°C/W
225 sq. mm	2500 sq. mm	2500 sq. mm	58°C/W
100 sq. mm	2500 sq. mm	2500 sq. mm	64°C/W
1000 sq. mm	1000 sq. mm	1000 sq. mm	57°C/W
1000 sq. mm	0	1000 sq. mm	60°C/W

\* Tab of device attached to topside copper

**Table 5. T0-92 Package**

	THERMAL RESISTANCE
Package alone	220°C/W
Package soldered into PC board with plated through holes only	175°C/W
Package soldered into PC board with 1/4 sq. inch of copper trace per lead	145°C/W
Package soldered into PC board with plated through holes in board, no extra copper trace, and a clip-on type heat sink:	
Thermalloy type 2224B	160°C/W
Aavid type 5754	135°C/W

### Calculating Junction Temperature

Example: given an output voltage of 3.3V, an input voltage range of 4.5V to 7V, an output current range of 0mA to 100mA, and a maximum ambient temperature of 50°C, what will the maximum junction temperature be?

Power dissipated by the device will be equal to:

$$I_{OUT\ MAX} \times (V_{IN\ MAX} - V_{OUT}) + (I_{GND} \times V_{IN})$$

where,  $I_{OUT\ MAX} = 100\text{mA}$

$$V_{IN\ MAX} = 7\text{V}$$

$$I_{GND\ at\ (I_{OUT} = 100\text{mA}, V_{IN} = 7\text{V})} = 5\text{mA}$$

$$\text{so, } P = 100\text{mA} \times (7\text{V} - 3.3\text{V}) + (5\text{mA} \times 7\text{V}) = 0.405\text{W}$$

If we use an SOT-223 package, then the thermal resistance will be in the range of 50°C/W to 65°C/W depending on copper area. So the junction temperature rise above ambient will be less than or equal to:

$$0.405\text{W} \times 60^\circ\text{C/W} = 24^\circ\text{C}$$

The maximum junction temperature will then be equal to the maximum junction temperature rise above ambient plus the maximum ambient temperature or:

$$T_{JMAX} = 50^\circ\text{C} + 24^\circ\text{C} = 74^\circ\text{C}$$

### Output Capacitance and Transient Performance

The LTC1121 is designed to be stable with a wide range of output capacitors. The minimum recommended value is 1µF with an ESR of 3Ω or less. For applications where space is very limited, capacitors as low as 0.33µF can be used if combined with a small series resistor. Assuming

## APPLICATIONS INFORMATION

that the ESR of the capacitor is low (ceramic) the suggested series resistor is shown in Table 5. The LT1121 is a micropower device and output transient response will be a function of output capacitance. See the Transient Response curves in the Typical Performance Characteristics. Larger values of output capacitance will decrease the peak deviations and provide improved output transient response. Bypass capacitors, used to decouple individual components powered by the LT1121, will increase the effective value of the output capacitor.

Table 5.

OUTPUT CAPACITANCE	SUGGESTED SERIES RESISTOR
0.33 $\mu$ F	2 $\Omega$
0.47 $\mu$ F	1 $\Omega$
0.68 $\mu$ F	1 $\Omega$
>1 $\mu$ F	None Needed

### Protection Features

The LT1121 incorporates several protection features which make it ideal for use in battery-powered circuits. In addition to the normal protection features associated with monolithic regulators, such as current limiting and thermal limiting, the device is protected against reverse input voltages, reverse output voltages, and reverse voltages from output to input.

Current limit protection and thermal overload protection are intended to protect the device against current overload conditions at the output of the device. For normal operation, the junction temperature should not exceed 125°C.

The input of the device will withstand reverse voltages of 30V. Current flow into the device will be limited to less than 1mA (typically less than 100 $\mu$ A) and no negative voltage will appear at the output. The device will protect both itself and the load. This provides protection against batteries that can be plugged in backwards.

For fixed voltage versions of the device, the output can be pulled below ground without damaging the device. If the input is open circuit or grounded the output can be pulled below ground by 20V. The output will act like an open circuit, no current will flow out of the pin. If the input is powered by a voltage source, the output will source the

short-circuit current of the device and will protect itself by thermal limiting. For the adjustable version of the device, the output pin is internally clamped at one diode drop below ground. Reverse current for the adjustable device must be limited to 5mA.

In circuits where a backup battery is required, several different input/output conditions can occur. The output voltage may be held up while the input is either pulled to ground, pulled to some intermediate voltage, or is left open circuit. Current flow back into the output will vary depending on the conditions. Many battery-powered circuits incorporate some form of power management. The following information will help optimize battery life. Table 6 summarizes the following information.

The reverse output current will follow the curve in Figure 2 when the input pin is pulled to ground. This current flows through the output pin to ground. The state of the shutdown pin will have no effect on output current when the input pin is pulled to ground.

In some applications it may be necessary to leave the input to the LT1121 unconnected when the output is held high. This can happen when the LT1121 is powered from a rectified AC source. If the AC source is removed, then the input of the LT1121 is effectively left floating. The reverse output current also follows the curve in Figure 2 if the input pin is left open. The state of the shutdown pin will have no effect on the reverse output current when the input pin is floating.

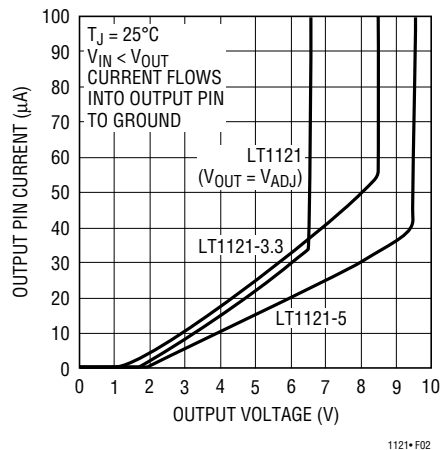

Figure 2. Reverse Output Current

## APPLICATIONS INFORMATION

When the input of the LT1121 is forced to a voltage below its nominal output voltage and its output is held high, the reverse output current will still follow the curve in Figure 2. This condition can occur if the input of the LT1121 is connected to a discharged (low voltage) battery and the output is held up by either a backup battery or by a second regulator circuit. When the input pin is forced below the output pin or the output pin is pulled above the input pin, the input current will typically drop to less than  $2\mu\text{A}$  (see Figure 3). The state of the shutdown pin will have no effect on the reverse output current when the output is pulled above the input.

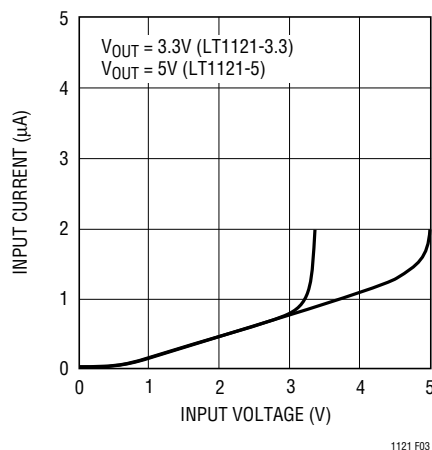

Figure 3. Input Current

Table 6. Fault Conditions

INPUT PIN	SHDN PIN	OUTPUT PIN	
$< V_{OUT}$ (Nominal)	Open (Hi)	Forced to $V_{OUT}$ (Nominal)	Reverse Output Current $\approx 15\mu\text{A}$ (See Figure 2) Input Current $\approx 1\mu\text{A}$ (See Figure 3)
$< V_{OUT}$ (Nominal)	Grounded	Forced to $V_{OUT}$ (Nominal)	Reverse Output Current $\approx 15\mu\text{A}$ (See Figure 2) Input Current $\approx 1\mu\text{A}$ (See Figure 3)
Open	Open (Hi)	Forced to $V_{OUT}$ (Nominal)	Reverse Output Current $\approx 15\mu\text{A}$ (See Figure 2)
Open	Grounded	Forced to $V_{OUT}$ (Nominal)	Reverse Output Current $\approx 15\mu\text{A}$ (See Figure 2)
$\leq 0.8\text{V}$	Open (Hi)	$\leq 0\text{V}$	Output Current = 0
$\leq 0.8\text{V}$	Grounded	$\leq 0\text{V}$	Output Current = 0
$> 1.5\text{V}$	Open (Hi)	$\leq 0\text{V}$	Output Current = Short-Circuit Current
$-30\text{V} < V_{IN} < 30\text{V}$	Grounded	$\leq 0\text{V}$	Output Current = 0

**PACKAGE DESCRIPTION** Dimensions in inches (millimeters) unless otherwise noted.

**N8 Package, 8-Lead Plastic DIP**

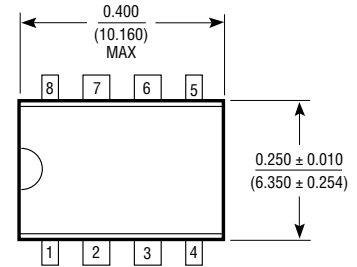
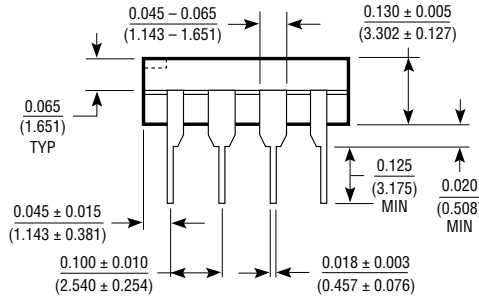
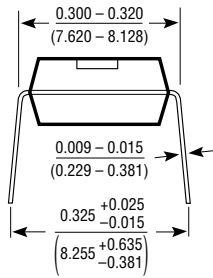

**S8 Package, 8-Lead Plastic SOIC**

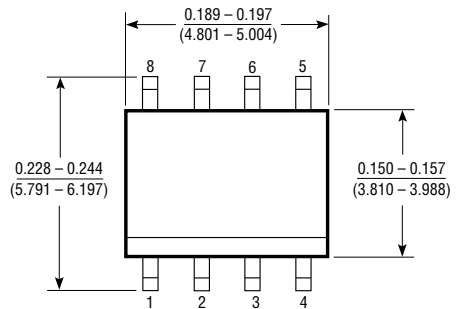
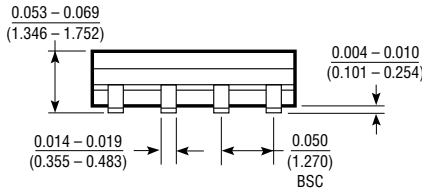
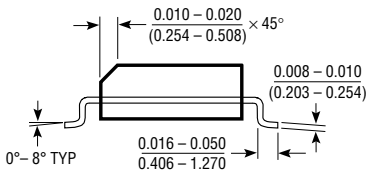

**ST Package, 3-Lead Plastic SOT-223**

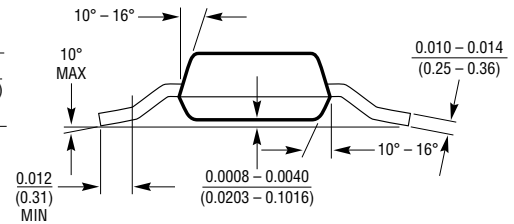
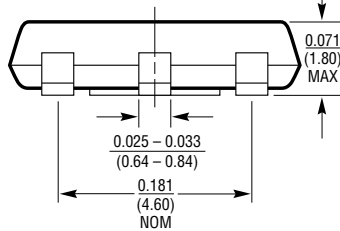
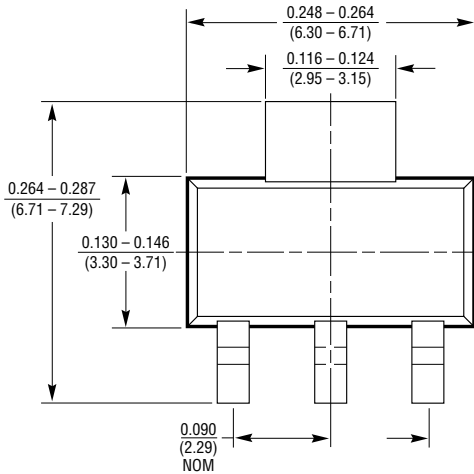

**Z Package, 3-Lead Plastic TO-92**

