

## FEATURES

- **Guaranteed Bias Current**  
 25°C ..... 100pA max.  
 -55°C to 125°C ..... 600pA max.
- **Guaranteed Offset Voltage** ..... 120μV max.
- **Guaranteed Drift** ..... 1.5μV/°C max.
- **Low Noise, 0.1Hz to 10Hz** ..... 0.5μVp-p
- **Guaranteed Low Supply Current** ..... 600μA max.
- **Guaranteed CMRR** ..... 114 dB min.
- **Guaranteed PSRR** ..... 114 db min.
- **Guaranteed Voltage Gain with 5mA load current**

## DESCRIPTION

The LT1008 is a universal precision operational amplifier which can be used in practically all precision applications. The LT1008 combines for the first time picoampere bias currents (which are maintained over the full -55°C to 125°C temperature range) microvolt offset voltage (and low drift with time and temperature), low voltage and current noise, and low power dissipation. Extremely high common-mode and power supply rejection ratios, and the ability to deliver 5mA load current with high voltage gain round out the LT1008's superb precision specifications.

**2**

The all around excellence of the LT1008 eliminates the necessity of the time consuming error analysis procedure of precision system design in many applications; the LT1008 can be stocked as the universal precision op amp.

The LT1008 is externally compensated with a single capacitor for additional flexibility in shaping the frequency response of the amplifier. It plugs into and upgrades all standard LM108A/308A applications. For an internally compensated version with even lower offset voltage but otherwise similar performance see the LT1012.

## APPLICATIONS

- Precision instrumentation
- Charge integrators
- Wide dynamic range logarithmic amplifiers
- Light meters
- Low frequency active filters
- Standard cell buffers
- Thermocouple amplifiers

Input Amplifier for 4½ Digit Voltmeter

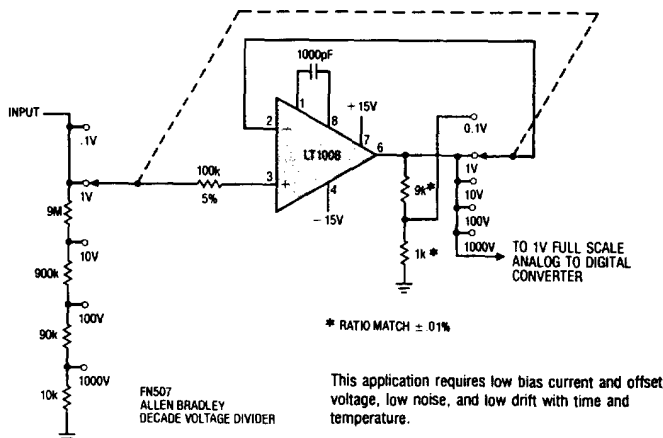

Input Bias Current vs Temperature

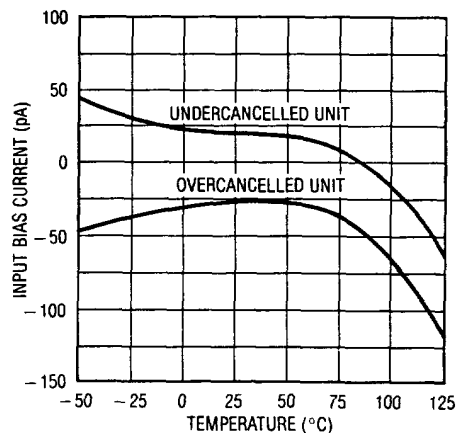

**ABSOLUTE MAXIMUM RATING**

Supply Voltage . . . . .  $\pm 20V$   
 Differential Input Current (Note 1). . . . .  $\pm 10mA$   
 Input Voltage . . . . .  $\pm 20V$   
 Output Short Circuit Duration . . . . . Indefinite  
 Operating Temperature Range  
   LT1008M . . . . .  $-55^{\circ}C$  to  $125^{\circ}C$   
   LT1008C . . . . .  $0^{\circ}C$  to  $70^{\circ}C$   
 Storage Temperature Range  
   All Devices . . . . .  $-65^{\circ}C$  to  $150^{\circ}C$   
 Lead Temperature (Soldering, 10 sec.) . . . . .  $300^{\circ}C$

**PACKAGE/ORDER INFORMATION**

|   |  |
|---|--|
| <p>TOP VIEW</p> <p>METAL CAN H PACKAGE</p>    | <p>ORDER PART NO.</p> <p>LT1008MH<br/>LT1008CH</p> |
| <p>TOP VIEW</p> <p>PLASTIC DIP N8 PACKAGE</p> | <p>LT1008CN8</p>                                   |

**ELECTRICAL CHARACTERISTICS**  $V_s = \pm 15V, V_{CM} = 0V, T_A = 25^{\circ}C$ , unless otherwise noted.

| SYMBOL    | PARAMETER                                | CONDITIONS                              | LT1008M    |            |           | LT1008C    |            |           | UNITS          |
|-----------|--|---|------------|------------|-----------|------------|------------|-----------|----------------|
|           |  |   | MIN        | TYP        | MAX       | MIN        | TYP        | MAX       |                |
| $V_{OS}$  | Input Offset Voltage                     | Note 2                                  |            | 30         | 120       |            | 30         | 120       | $\mu V$        |
|           | Long Term Input Offset Voltage Stability |   |            | 0.3        |           |            | 0.3        |           | $\mu V/month$  |
| $I_{OS}$  | Input Offset Current                     | Note 2                                  |            | 30         | 100       |            | 30         | 100       | pA             |
|           |  |   |            | 40         | 150       |            | 40         | 150       | pA             |
| $I_B$     | Input Bias Current                       | Note 2                                  |            | $\pm 30$   | $\pm 100$ |            | $\pm 30$   | $\pm 100$ | pA             |
|           |  |   |            | $\pm 40$   | $\pm 150$ |            | $\pm 40$   | $\pm 150$ | pA             |
| $e_n$     | Input Noise Voltage                      | 0.1Hz to 10Hz                           |            | 0.5        |           |            | 0.5        |           | $\mu Vp-p$     |
| $e_n$     | Input Noise Voltage Density              | $f_0 = 10Hz$ (Note 3)                   |            | 17         | 30        |            | 17         | 30        | $nV/\sqrt{Hz}$ |
|           |  | $f_0 = 1000Hz$ (Note 4)                 |            | 14         | 22        |            | 14         | 22        | $nV/\sqrt{Hz}$ |
| $i_n$     | Input Noise Current Density              | $f_0 = 10Hz$                            |            | 20         |           |            | 20         |           | $fA/\sqrt{Hz}$ |
| $A_{VOL}$ | Large Signal Voltage Gain                | $V_{OUT} = \pm 12V, R_L \geq 10k\Omega$ | 200        | 2000       |           | 200        | 2000       |           | V/mV           |
|           |  | $V_{OUT} = \pm 10V, R_L \geq 2k\Omega$  | 120        | 600        |           | 120        | 600        |           | V/mV           |
| CMRR      | Common Mode Rejection Ratio              | $V_{CM} = \pm 13.5V$                    | 114        | 132        |           | 114        | 132        |           | dB             |
| PSRR      | Power Supply Rejection Ratio             | $V_s = \pm 2V$ to $\pm 20V$             | 114        | 132        |           | 114        | 132        |           | dB             |
|           | Input Voltage Range                      |   | $\pm 13.5$ | $\pm 14.0$ |           | $\pm 13.5$ | $\pm 14.0$ |           | V              |
| $V_{OUT}$ | Output Voltage Swing                     | $R_L = 10k\Omega$                       | $\pm 13$   | $\pm 14$   |           | $\pm 13$   | $\pm 14$   |           | V              |
|           | Slew Rate                                | $C_f = 30pF$                            | 0.1        | 0.2        |           | 0.1        | 0.2        |           | $V/\mu sec$    |
| $I_S$     | Supply Current                           | Note 2                                  |            | 380        | 600       |            | 380        | 600       | $\mu A$        |

# ELECTRICAL CHARACTERISTICS $V_S = \pm 15V, V_{CM} = 0V, 0^\circ C \leq T_A \leq 70^\circ C$ for the LT1008C and $-55^\circ C \leq T_A \leq 125^\circ C$ for the LT1008M, unless otherwise noted.

| SYMBOL    | PARAMETER                    | CONDITIONS                              | LT1008M |            |           | LT1008C    |           |                  | UNITS |
|-----------|------------------------------|---|---------|------------|-----------|------------|-----------|------------------|-------|
|           |                              |   | MIN     | TYP        | MAX       | MIN        | TYP       | MAX              |       |
| $V_{OS}$  | Input Offset Voltage         | Note 2                                  | ●       | 50         | 250       | 40         | 180       | $\mu V$          |       |
|           |                              |   | ●       | 60         | 320       | 50         | 250       | $\mu V$          |       |
| $I_{OS}$  | Input Offset Current         | Note 2                                  | ●       | 0.2        | 1.5       | 0.2        | 1.5       | $\mu V/^\circ C$ |       |
|           |                              |   | ●       | 80         | 350       | 50         | 250       | pA               |       |
| $I_b$     | Input Bias Current           | Note 2                                  | ●       | 0.4        | 2.5       | 0.4        | 2.5       | pA/°C            |       |
|           |                              |   | ●       | $\pm 80$   | $\pm 600$ | $\pm 40$   | $\pm 180$ | pA               |       |
| $A_{VOL}$ | Large Signal Voltage Gain    | $V_{OUT} = \pm 12V, R_L \geq 10k\Omega$ | ●       | $\pm 150$  | $\pm 800$ | $\pm 50$   | $\pm 250$ | pA               |       |
|           |                              |   | ●       | 0.6        | 6.0       | 0.4        | 2.5       | pA/°C            |       |
| CMRR      | Common Mode Rejection Ratio  | $V_{CM} = \pm 13.5V$                    | ●       | 100        | 1000      | 150        | 1500      | V/mV             |       |
| PSRR      | Power Supply Rejection Ratio | $V_S = \pm 2.5V$ to $\pm 20V$           | ●       | 108        | 128       | 110        | 130       | dB               |       |
| $V_{OUT}$ | Output Voltage Swing         | $R_L = 10k\Omega$                       | ●       | $\pm 13.5$ |           | $\pm 13.5$ |           | V                |       |
|           |                              |   | ●       | $\pm 13$   | $\pm 14$  | $\pm 13$   | $\pm 14$  | V                |       |
| $I_S$     | Supply Current               |   | ●       | 400        | 800       | 400        | 800       | $\mu A$          |       |

2

The ● denotes the specifications which apply over the full operating temperature range.

**Note 1:** Differential input voltages greater than 1V will cause excessive current to flow through the input protection diodes unless current limiting resistors are used.

**Note 2:** These specifications apply for  $\pm 2V \leq V_S \leq \pm 20V$  ( $\pm 2.5V \leq V_S \leq \pm 20V$  over the temperature range) and  $-13.5V \leq V_{CM} \leq 13.5V$  (for  $V_S = \pm 15V$ ).

**Note 3:** 10Hz noise voltage density is sample tested on every lot. Devices 100% tested at 10Hz are available on request.

**Note 4:** This parameter is tested on a sample basis only.

## FREQUENCY COMPENSATION CIRCUITS

Standard Compensation Circuit

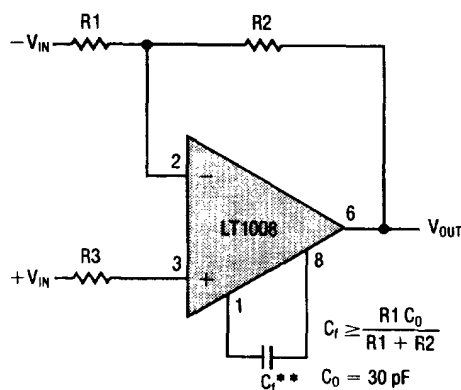

\*\* BANDWIDTH AND SLEW RATE ARE PROPORTIONAL TO  $1/C_f$

Alternate\* Frequency Compensation

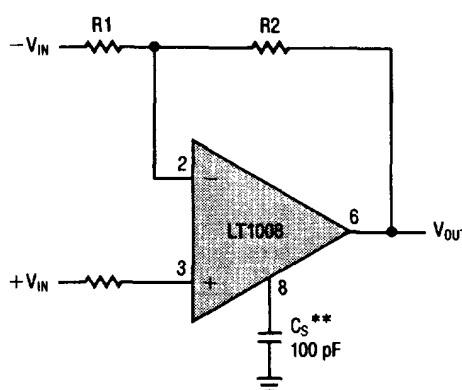

\* IMPROVES REJECTION OF POWER SUPPLY NOISE BY A FACTOR OF 5.

\*\* BANDWIDTH AND SLEW RATE ARE PROPORTIONAL TO  $1/C_s$

FOR  $\frac{R2}{R1} > 200$  NO EXTERNAL FREQUENCY COMPENSATION IS NECESSARY

# TYPICAL PERFORMANCE CHARACTERISTICS

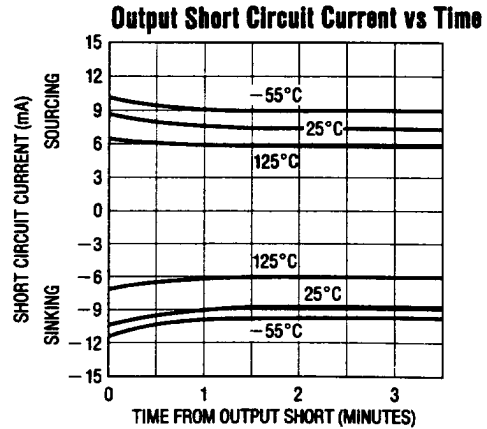
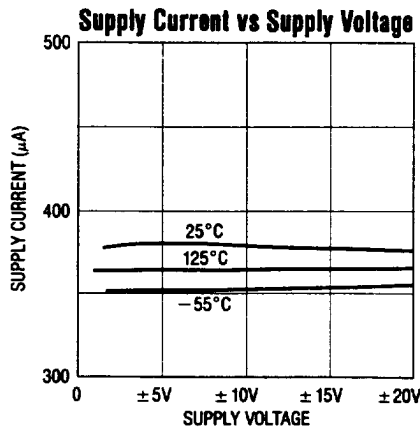
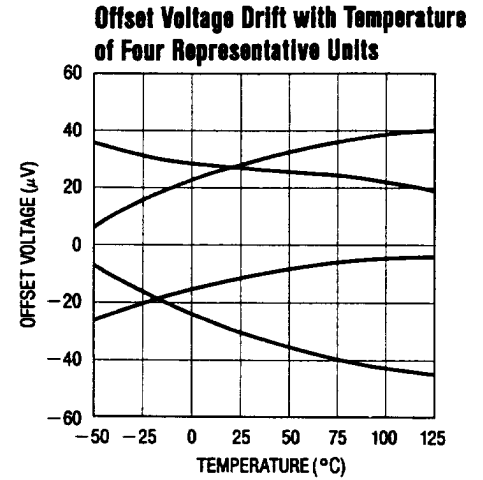
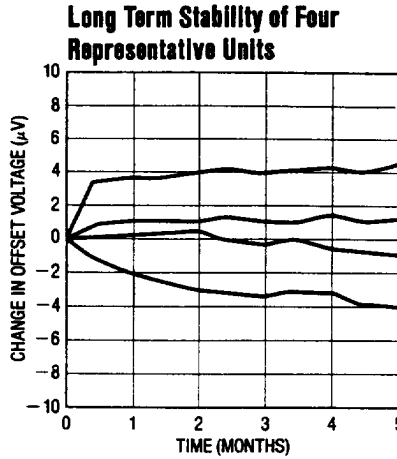
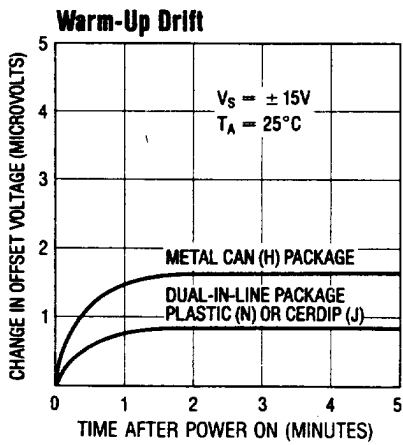
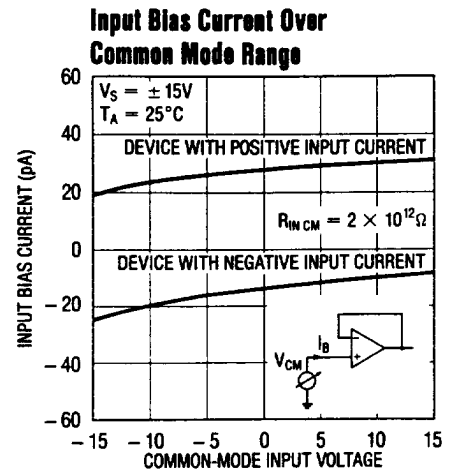
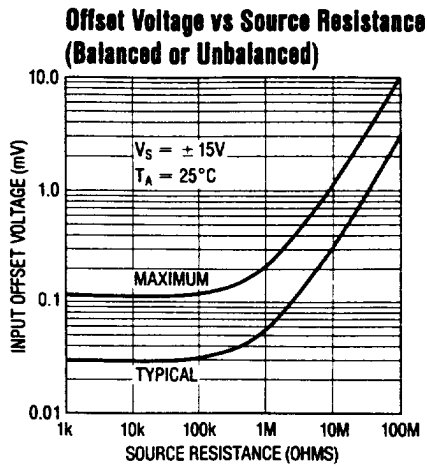
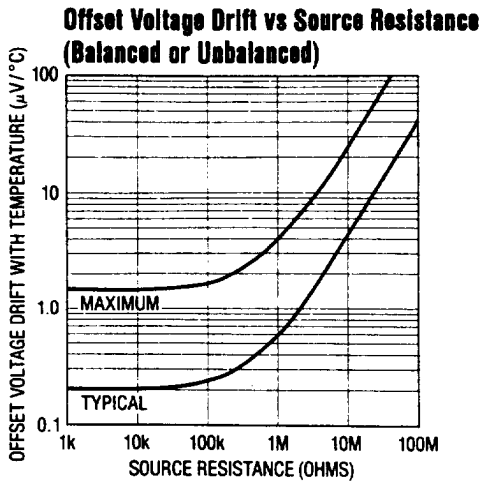

# TYPICAL PERFORMANCE CHARACTERISTICS

2

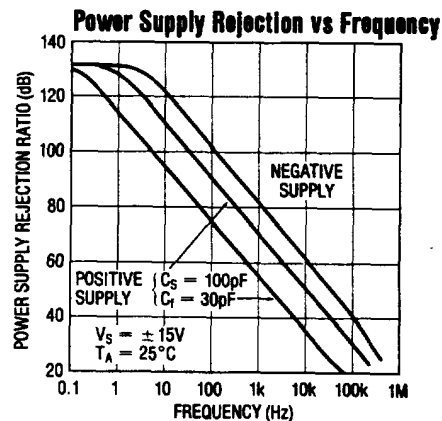
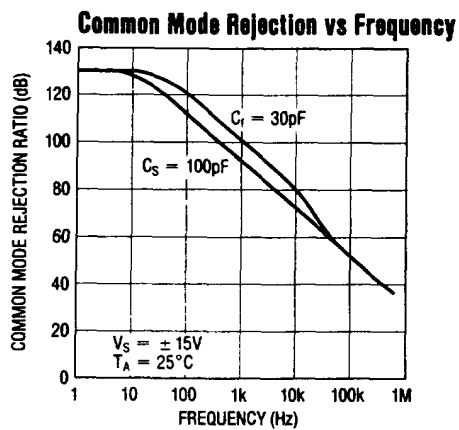
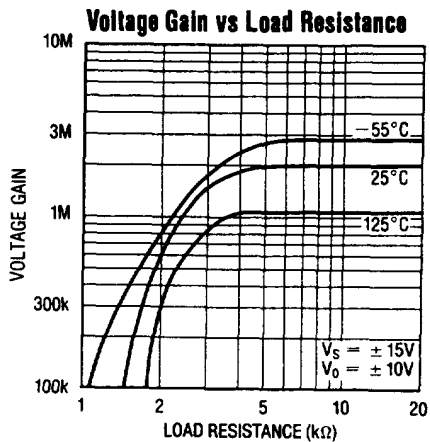
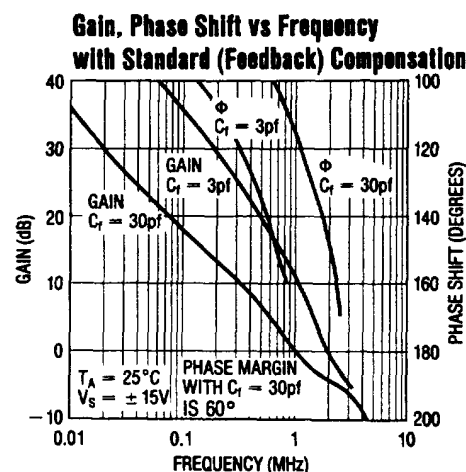
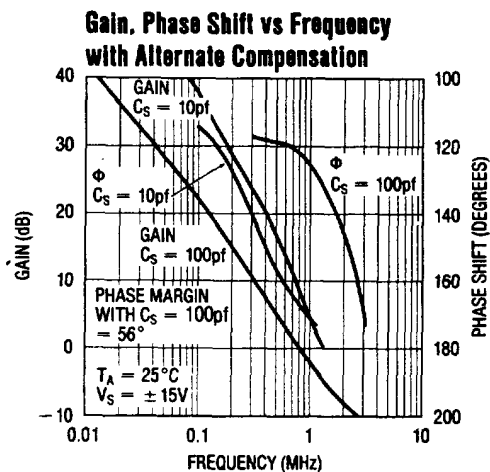
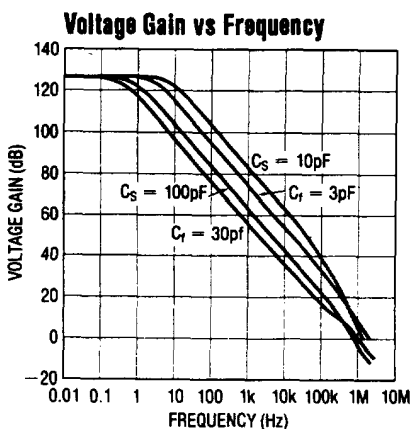
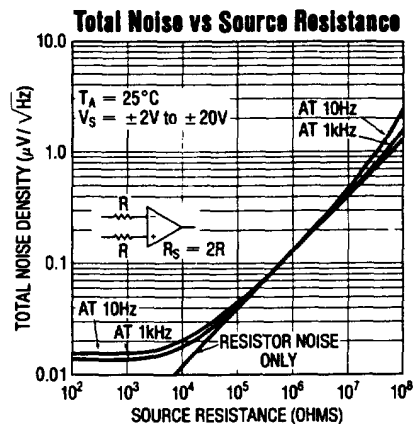
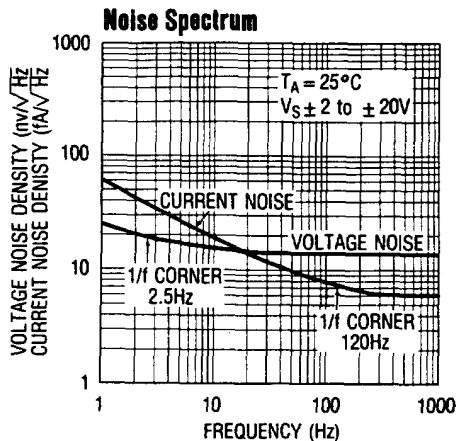
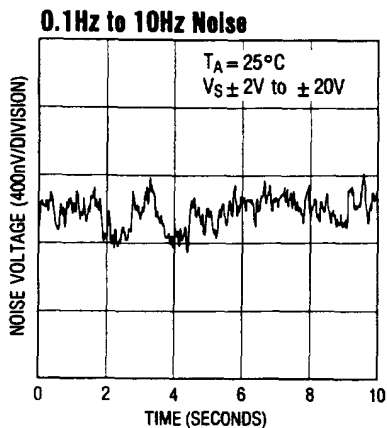

**Large Signal Transient Response**

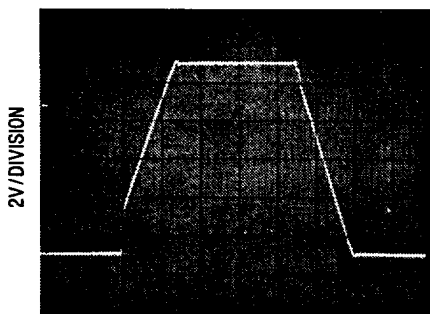

$A_v = +1, C_s = 100\text{pF}, 20\mu\text{sec}/\text{DIV}$

**Slew Rate vs Compensation Capacitance**

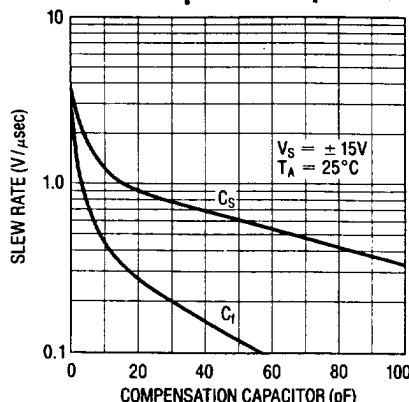

**Large Signal Transient Response**

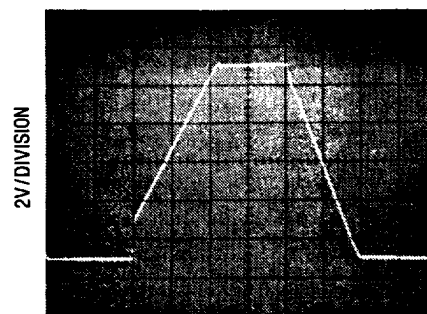

$A_v = +1, C_l = 30\text{pF}, 20\mu\text{sec}/\text{DIV}$

**Small Signal Transient Response**

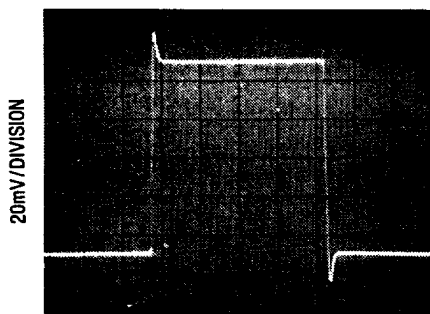

$A_v = +1, C_s = 100\text{pF}, C_{\text{LOAD}} = 100\text{pF}, 5\mu\text{sec}/\text{DIV}$

**Small Signal Transient Response**

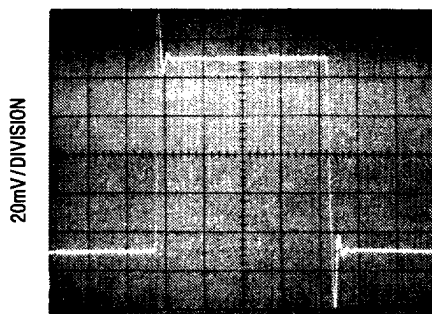

$A_v = +1, C_s = 100\text{pF}, C_{\text{LOAD}} = 600\text{pF}, 5\mu\text{sec}/\text{DIV}$

**Small Signal Transient Response**

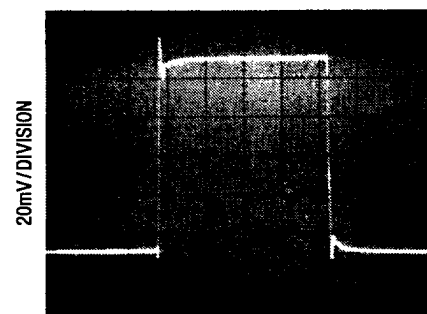

$A_v = +1, C_l = 30\text{pF}, C_{\text{LOAD}} = 100\text{pF}, 5\mu\text{sec}/\text{DIV}$

**APPLICATIONS INFORMATION**

**Achieving Picoampere/Microvolt Performance**

In order to realize the picoampere — microvolt level accuracy of the LT1008, proper care must be exercised. For example, leakage currents in circuitry external to the op amp can significantly degrade performance. High quality insulation should be used (e.g. Teflon, Kel-F); cleaning of all insulating surfaces to remove fluxes and other residues will probably be required. Surface coating may be necessary to provide a moisture barrier in high humidity environments.

Board leakage can be minimized by encircling the input circuitry with a guard ring operated at a potential close to that of the inputs: in inverting configurations the guard ring should be tied to ground, in non-invert-

ing connections to the inverting input at pin 2. Guarding both sides of the printed circuit board is required. Bulk leakage reduction depends on the guard ring width. Nanoampere level leakage into the compensation terminals can affect offset voltage and drift with temperature.

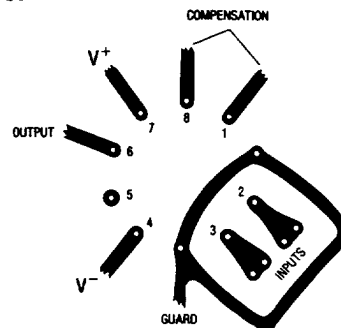

## APPLICATIONS INFORMATION

Microvolt level error voltages can also be generated in the external circuitry. Thermocouple effects caused by temperature gradients across dissimilar metals at the contacts to the input terminals can exceed the inherent drift of the amplifier. Air currents over device leads should be minimized, package leads should be short, and the two input leads should be as close together as possible and maintained at the same temperature.

The LT1008 is specified over a wide range of power-supply voltages from  $\pm 2V$  to  $\pm 18V$ . Operation with lower supplies is possible down to  $\pm 1.0V$  (two Ni-Cad-batteries).

Test Circuit for Offset Voltage and its Drift with Temperature

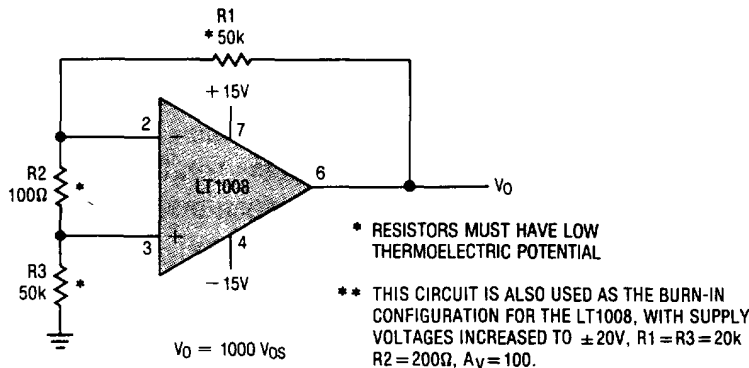

2

### Noise Testing

The 0.1Hz to 10Hz peak-to-peak noise of the LT1008 is measured in the test circuit shown. The frequency response of this noise tester indicates that the 0.1Hz corner is defined by only one zero. The test time to measure 0.1Hz to 10Hz noise should not exceed 10 seconds, as this time limit acts as an additional zero to eliminate noise contributions from the frequency band below 0.1Hz.

A noise-voltage density test is recommended when measuring noise on a large number of units. A 10Hz noise-voltage density measurement will correlate well with a 0.1Hz to 10Hz peak-to-peak noise reading since both results are determined by the white noise and the location of the 1/f corner frequency.

Current noise is measured in the circuit shown and calculated by the following formula where the noise of the source resistors is subtracted.

0.1Hz to 10Hz Noise Test Circuit

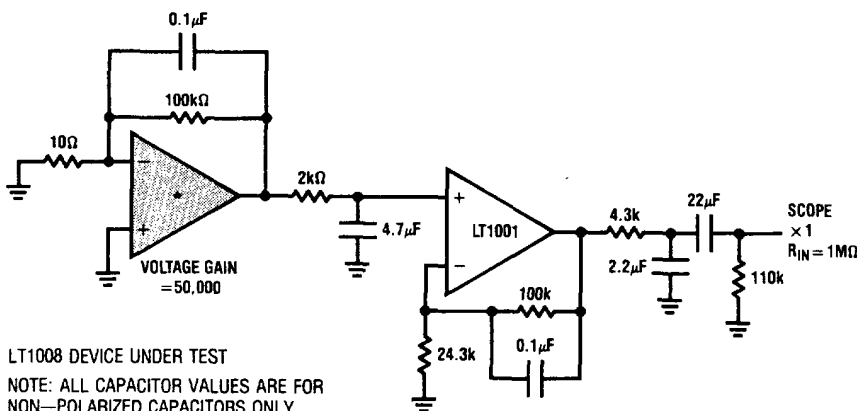

$$i_n = \frac{[e^2_{no} - (820nV)^2]^{1/2}}{40M\Omega \times 100}$$

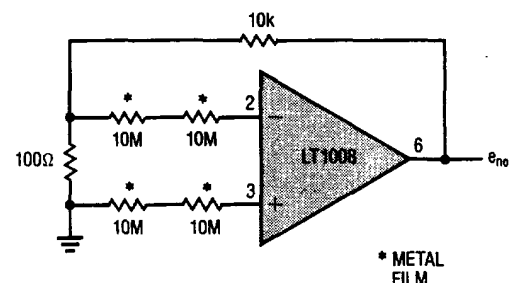

# APPLICATIONS INFORMATION

## Frequency Compensation

The LT1008 is externally frequency compensated with a single capacitor. The two standard compensation circuits shown on page 3 are identical to the LM108A/308A frequency compensation schemes. Therefore, the LT1008 operational amplifiers can be inserted directly into LM108A/308A sockets, with similar AC and upgraded DC performance.

External frequency compensation provides the user with additional flexibility in shaping the frequency response of the amplifier. For example, for a voltage gain of ten, and  $C_f = 3\text{pF}$ , a gain bandwidth product of 5MHz and slew rate of  $1.2\text{V}/\mu\text{sec}$  can be realized. For closed loop gains in excess of 200, no external compensation is necessary, and slew rate increases to  $4\text{V}/\mu\text{sec}$ . The LT1008 can also be overcompensated (i.e.  $C_f > 30\text{pF}$  or  $C_S > 100\text{pF}$ ) to improve capacitive load handling capability or to narrow noise band-

width. In many applications, the feedback loop around the amplifier has gain (e.g. logarithmic amplifiers); overcompensation can stabilize these circuits with a single capacitor.

The availability of the compensation terminals permits the use of feedforward frequency compensation to enhance slew rate in low closed loop gain configurations. The inverter slew rate is increased to  $1.4\text{V}/\mu\text{sec}$ . The voltage follower feedforward scheme bypasses the amplifier's gain stages and slews at nearly  $10\text{V}/\mu\text{sec}$ .

The inputs of the LT1008 are protected with back-to-back diodes. Current limiting resistors are not used, because the leakage of these resistors would prevent the realization of picoampere level bias currents at elevated temperatures. In the voltage follower configuration, when the input is driven by a fast, large signal pulse ( $> 1\text{V}$ ), the input protection diodes effectively short the output to the input during slewing, and a current, limited only by the output short circuit protection will flow through the diodes.

The use of a feedback resistor, as shown in the voltage follower, feedforward diagram, is recommended because this resistor keeps the current below the short circuit limit, resulting in faster recovery and settling of the output.

### Inverter Feedforward Compensation

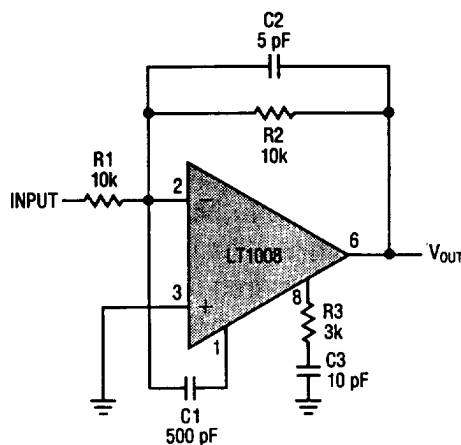

### Follower Feedforward Compensation

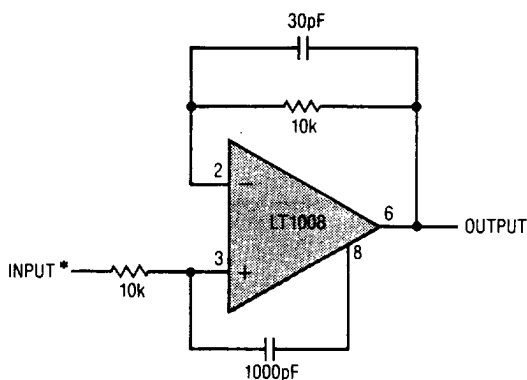

\* SOURCE RESISTANCE  $\leq 15\text{k}$  FOR STABILITY

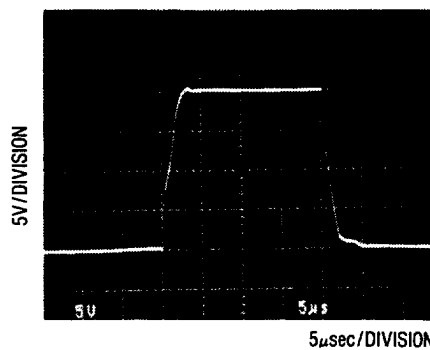
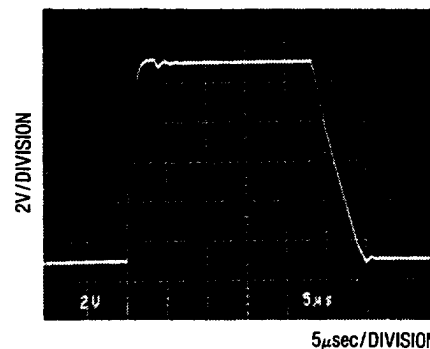



# APPLICATIONS

## Logarithmic Amplifier

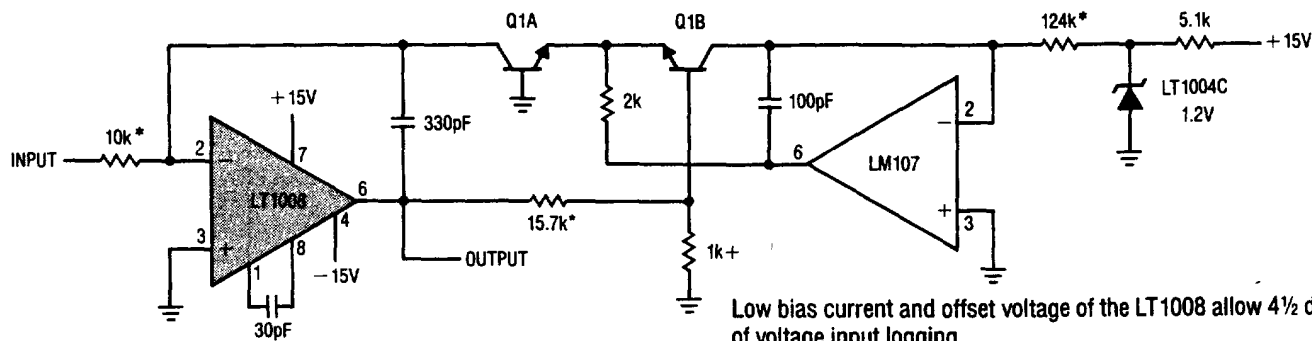

Low bias current and offset voltage of the LT1008 allow 4½ decades of voltage input logging.

- + = TEL. LABS, TYPE Q81
- \* = 1% FILM RESISTOR
- Q1 = 2N2979

2

## Amplifier for Bridge Transducers

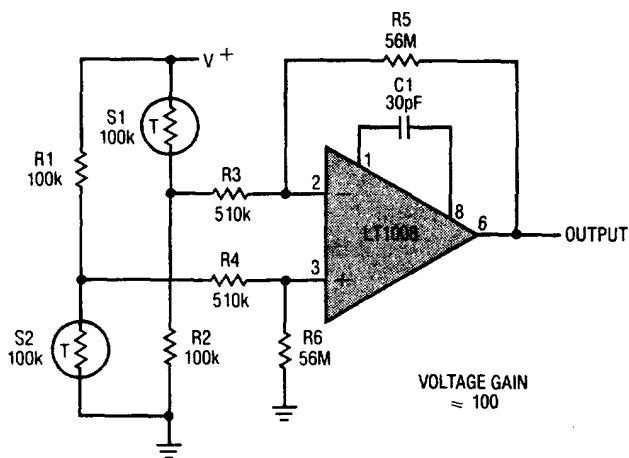

## Saturated Standard Cell Amplifier

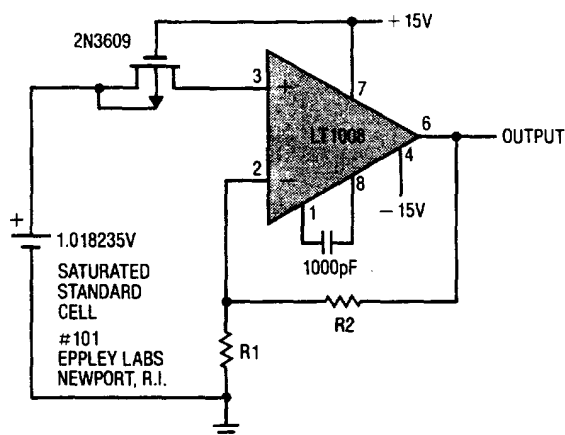

The typical 30pA bias current of the LT1008 will degrade the standard cell by only 1 ppm/year. Noise is a fraction of a ppm. Unprotected gate MOSFET isolates standard cell on power down.

## Amplifier For Photodiode Sensor

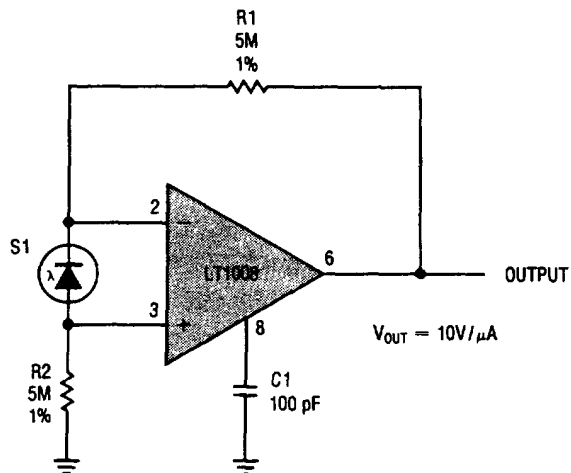

## Five Decade Kelvin-Varley Divider Buffered by the LT1008

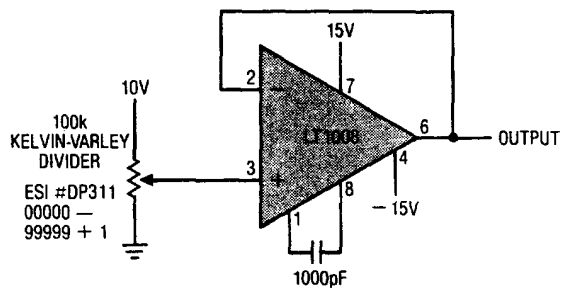

Approximate error due to noise, bias current, common-mode rejection, voltage gain of the amplifier is 1/5 of a least significant bit.





**SCHEMATIC DIAGRAM**

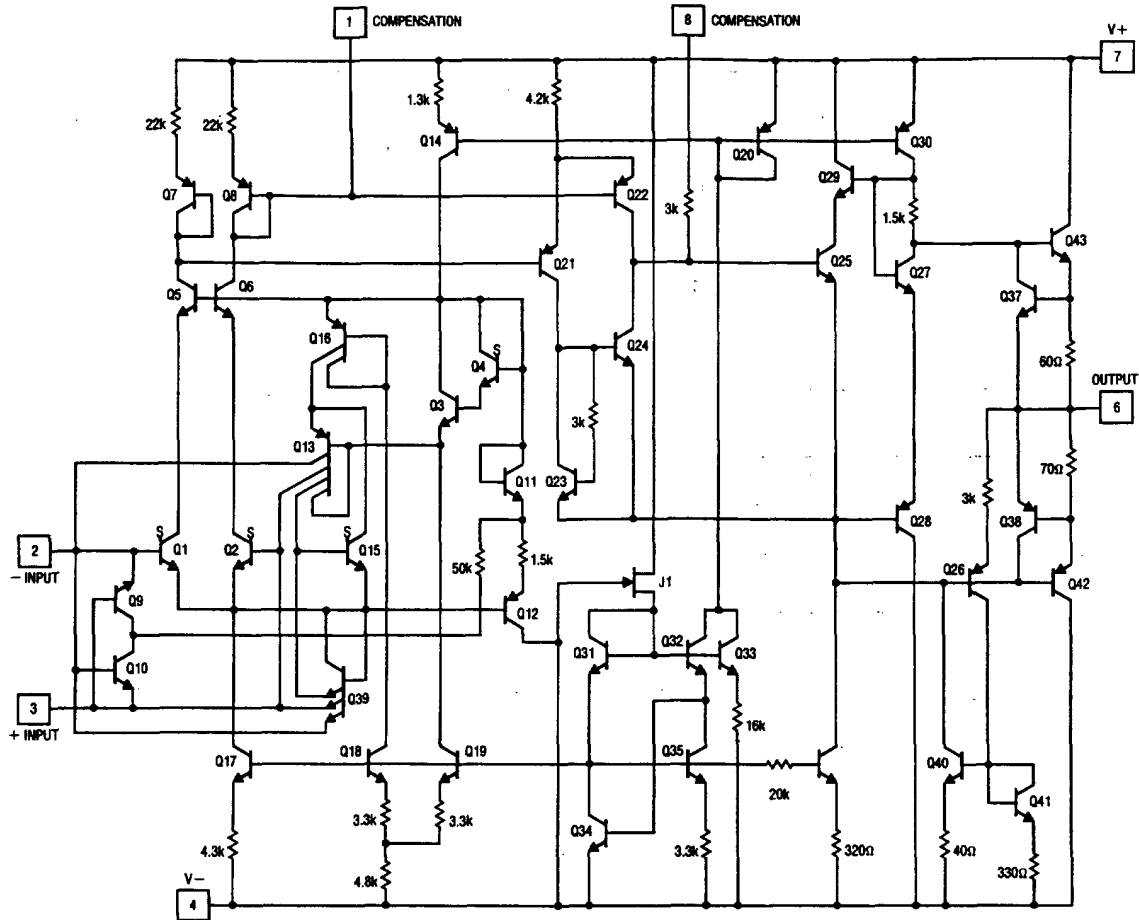

**PACKAGE DESCRIPTION**

**H Package  
Metal Can**

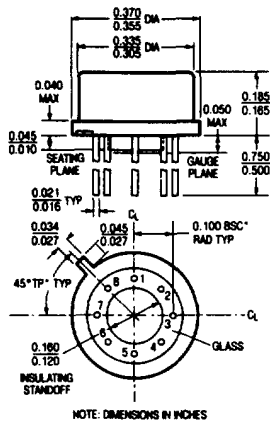

NOTE: DIMENSIONS IN INCHES

|            |               |               |
|------------|---------------|---------------|
| $T_{jmax}$ | $\theta_{ja}$ | $\theta_{jc}$ |
| 150°C      | 150°C/W       | 45°C/W        |

**J8 Package  
8 Lead Hermetic Dip**

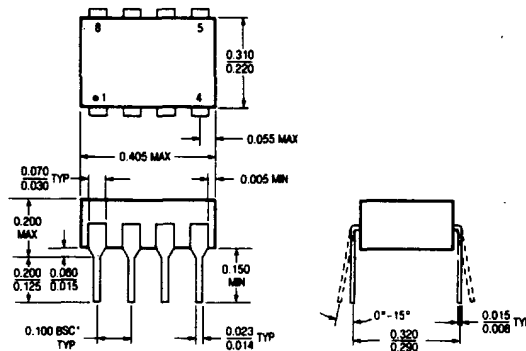

NOTE: DIMENSIONS IN INCHES UNLESS OTHERWISE NOTED.  
\*LEADS WITHIN 0.007 OF TRUE POSITION (TP) AT GAUGE PLANE

|            |               |
|------------|---------------|
| $T_{jmax}$ | $\theta_{ja}$ |
| 150°C      | 100°C/W       |

**N8 Package  
8 Lead Plastic**

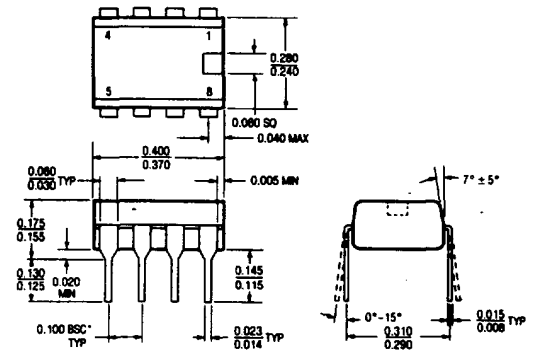

NOTE: DIMENSIONS IN INCHES UNLESS OTHERWISE NOTED.  
\*LEADS WITHIN 0.007 OF TRUE POSITION (TP) AT GAUGE PLANE.

|            |               |
|------------|---------------|
| $T_{jmax}$ | $\theta_{ja}$ |
| 100°C      | 130°C/W       |