



# Technical Data Sheet

## 5mm Infrared LED, T-1 3/4

### IR333C/H2/L10

#### Features

- High reliability
- 2.54mm lead spacing
- Low forward voltage
- Good spectral matching to Si photodetector
- High radiant intensity

#### Descriptions

EVERLIGHT's infrared emitting diode (IR333C/H2/L10) is a high intensity diode, molded in a water clear plastic package.

The device is spectrally matched with phototransistor, photodiode and infrared receive module.

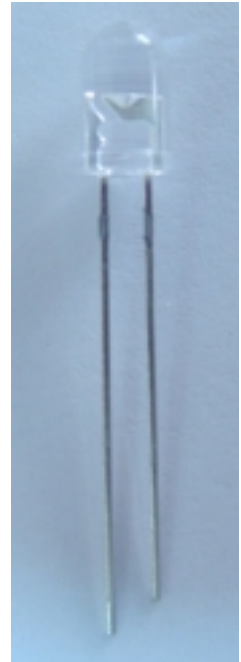

#### Applications

- Free air transmission system
- Optoelectronic switch
- Floppy disk drive
- Infrared applied system
- Smoke detector

#### Device Selection Guide

LED Part No.	Chip	Lens Color
	Material	
IR	GaAlAs	Water clear

Device No:DIR-033-143

**Package Dimensions**

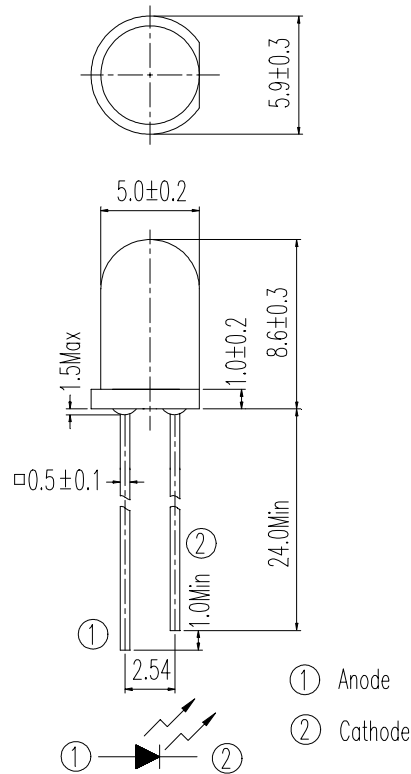

- Notes:** 1.All dimensions are in millimeters  
 2.Tolerances unless dimensions  $\pm 0.25\text{mm}$

**Absolute Maximum Ratings (Ta=25°C)**

Parameter	Symbol	Rating	Units
Continuous Forward Current	$I_F$	100	mA
Peak Forward Current	$I_{FP}$	1.0	A
Reverse Voltage	$V_R$	5	V
Operating Temperature	$T_{opr}$	-40 ~ +85	°C
Storage Temperature	$T_{stg}$	-40 ~ +85	°C
Soldering Temperature	$T_{sol}$	260	°C
Power Dissipation at(or below) 25°C Free Air Temperature	$P_d$	150	mW

**Notes:** \*1: $I_{FP}$  Conditions--Pulse Width  $\leq 100 \mu s$  and Duty  $\leq 1\%$ .

\*2:Soldering time  $\leq 5$  seconds.

Device No:DIR-033-143

**Electro-Optical Characteristics (Ta=25°C)**

Parameter	Symbol	Condition	Min.	Typ.	Max.	Units
Radiant Intensity	E <sub>e</sub>	I <sub>F</sub> =20mA	7.8	15	--	mW/sr
		I <sub>F</sub> =100mA Pulse Width ≤ 100 μs and Duty ≤ 1%	--	70	--	
		I <sub>F</sub> =1A Pulse Width ≤ 100 μs and Duty ≤ 1%	--	700	--	
Peak Wavelength	λ <sub>p</sub>	I <sub>F</sub> =20mA	--	940	--	nm
Spectral Bandwidth	Δ λ	I <sub>F</sub> =20mA	--	45	--	nm
Forward Voltage	V <sub>F</sub>	I <sub>F</sub> =20mA	--	1.2	1.5	V
		I <sub>F</sub> =100mA Pulse Width ≤ 100 μs and Duty ≤ 1%	--	1.4	1.8	
		I <sub>F</sub> =1A Pulse Width ≤ 100 μs and Duty ≤ 1%	--	2.6	4.0	
Reverse Current	I <sub>R</sub>	V <sub>R</sub> =5V	--	--	10	μA
View Angle	2 θ 1/2	I <sub>F</sub> =20mA	--	30	--	deg

**Typical Electro-Optical Characteristics Curves**

Fig.1 Forward Current vs. Ambient Temperature

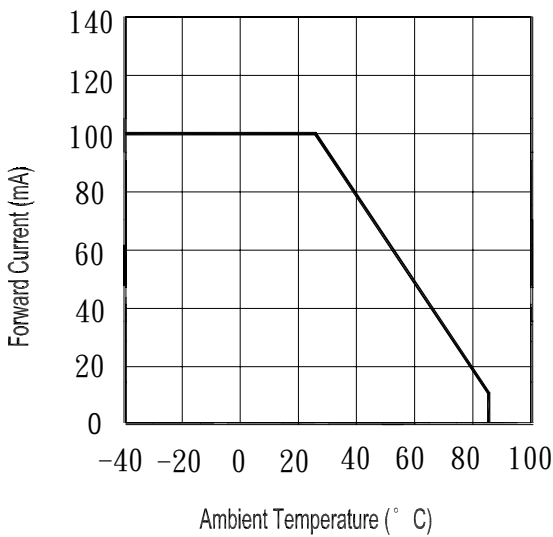

Fig.2 Spectral Distribution

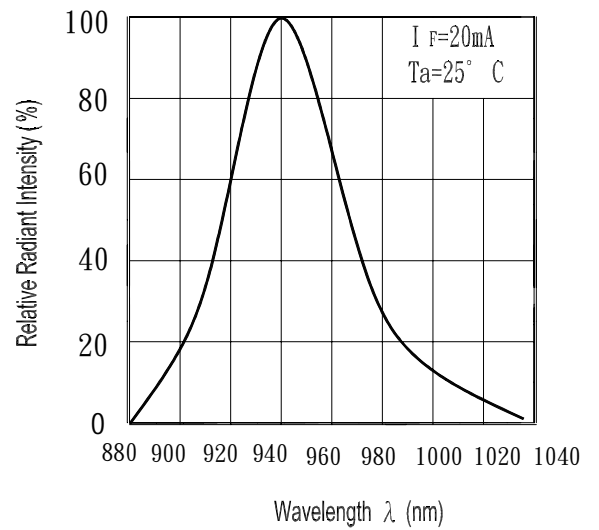

Fig.3 Peak Emission Wavelength vs. Ambient Temperature

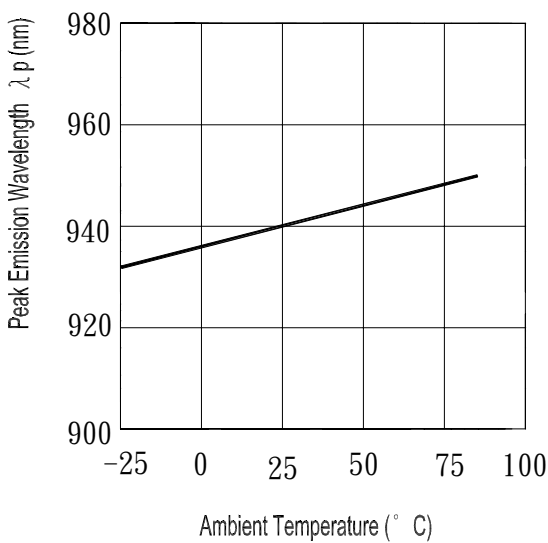
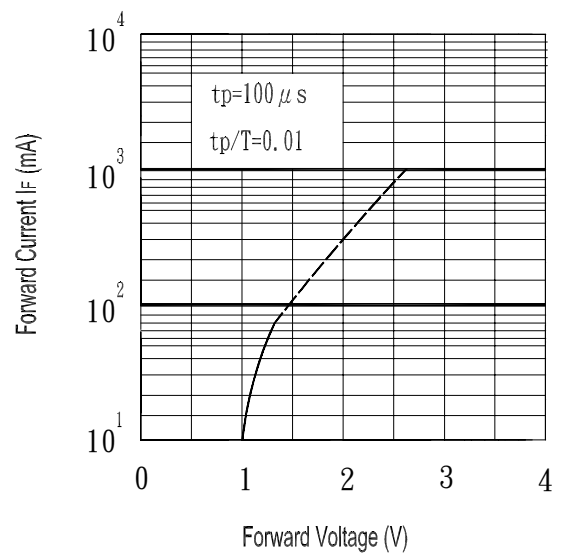

Fig.4 Forward Current vs. Forward Voltage



Device No:DIR-033-143

**Typical Electro-Optical Characteristics Curves**

Fig.5 Relative Intensity vs. Forward Current

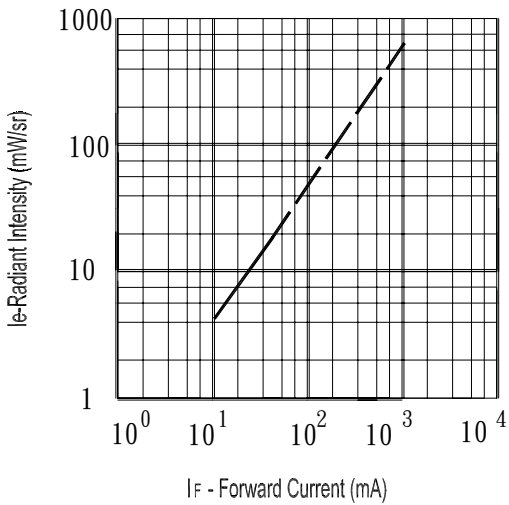

Fig.7 Relative Intensity vs. Ambient Temperature (° C)

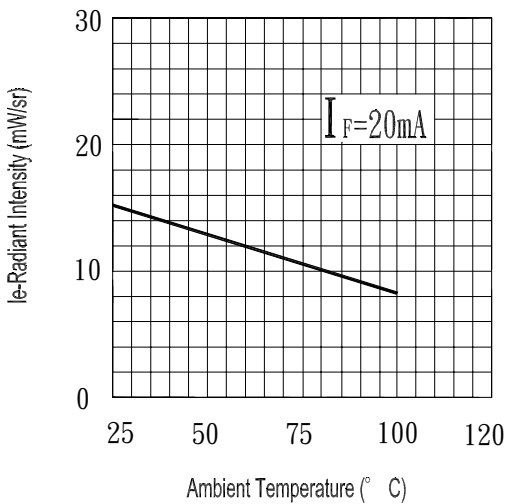

Fig.6 Relative Radiant Intensity vs. Angular Displacement

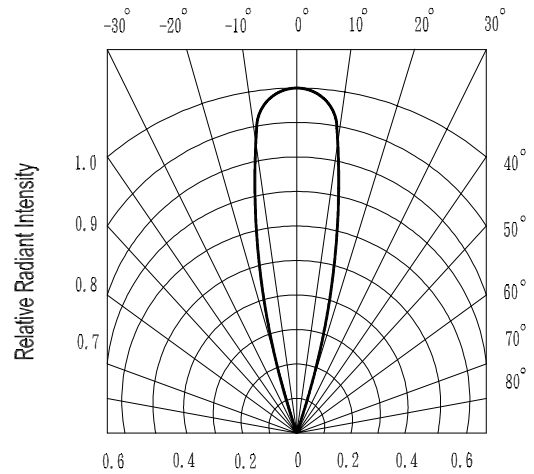
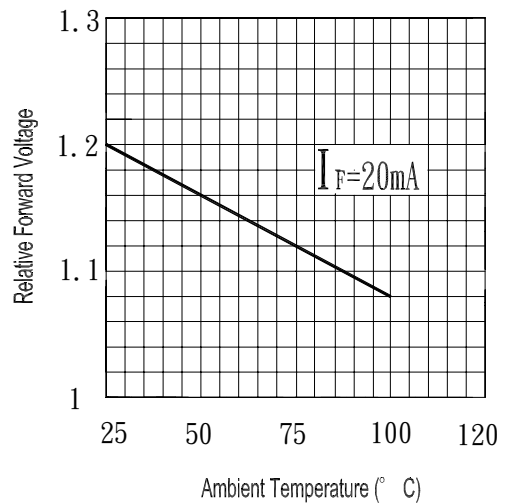

Fig.8 Forward Current vs. Ambient Temperature (° C)





**IR333C/H2/L10**

**Reliability Test Item And Condition**

The reliability of products shall be satisfied with items listed below.

Confidence level : 90%

LTPD : 10%

NO.	Item	Test Conditions	Test Hours/ Cycles	Sample Sizes	Failure Judgement Criteria	Ac/Re
1	Solder Heat	TEMP. : 260°C ± 5°C	10secs	22pcs	$I_R \geq U \times 2$ $E_e \leq L \times 0.8$ $V_F \geq U \times 1.2$  U : Upper Specification  Limit L : Lower Specification Limit	0/1
2	Temperature Cycle	H : +85°C    30mins ↕ 5mins L : -55°C    30mins	50Cycles	22pcs		0/1
3	Thermal Shock	H : +100°C    5mins ↕ 10secs L : -10°C     5mins	50Cycles	22pcs		0/1
4	High Temperature Storage	TEMP. : +100°C	1000hrs	22pcs		0/1
5	Low Temperature Storage	TEMP. : -55°C	1000hrs	22pcs		0/1
6	DC Operating Life	$I_F = 20\text{mA}$	1000hrs	22pcs		0/1
7	High Temperature/ High Humidity	85°C / 85% R.H	1000hrs	22pcs		0/1

**EVERLIGHT ELECTRONICS CO., LTD.**  
 Office: No 25, Lane 76, Sec 3, Chung Yang Rd,  
 Tucheng, Taipei 236, Taiwan, R.O.C

Tel: 886-2-2267-2000, 2267-9936  
 Fax: 886-2267-6244, 2267-6189, 2267-6306  
<http://www.everlight.com>

**Device No:DIR-033-143**