

T-1³/₄ (5 mm) Low Profile LED Lamps

Technical Data

HLMP-335X Series
HLMP-336X Series
HLMP-345X Series
HLMP-346X Series
HLMP-355X Series
HLMP-356X Series

Features

- High Intensity
- Low Profile: 5.8 mm (0.23 in.) Nominal
- T-1³/₄ Diameter Package
- Diffused and Non-diffused Types
- General Purpose Leads
- IC Compatible/Low Current Requirements
- Reliable and Rugged

The HLMP-355X/-356X Series are Gallium Phosphide Green Light Emitting Diodes.

The Low Profile T-1³/₄ package provides space savings and is excellent for backlighting applications.

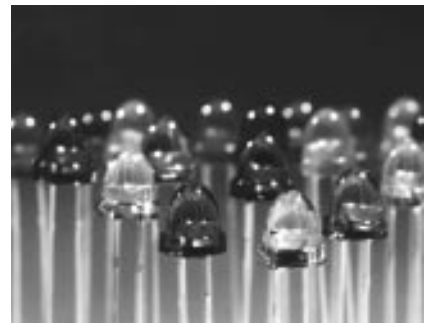

Description

The HLMP-335X/-336X Series are Gallium Arsenide Phosphide on Gallium Phosphide High Efficiency Red Light Emitting Diodes.

The HLMP-345X/-346X Series are Gallium Arsenide Phosphide on Gallium Phosphide Yellow Light Emitting Diodes.

Package Dimensions

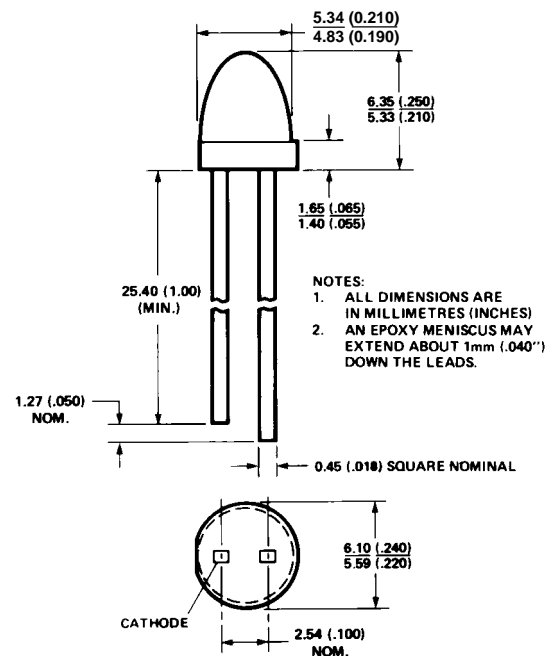

Selection Guide

Part Number HLMP-	Application	Minimum Intensity @ 10 mA (mcd)	Lens
3350	Indicator – General Purpose	2.1	Tinted Diffused Wide Angle
3351	Indicator – High Brightness	5.4	HER
3365	General Purpose Point Source	8.6	Tinted Non-diffused Narrow Angle
3366	Indicator – High Brightness	13.8	HER
3450	Indicator – General Purpose	2.2	Tinted Diffused Wide Angle
3451	Indicator – High Brightness	5.7	Yellow
3465	General Purpose Point Source	5.7	Tinted Non-diffused Narrow Angle
3466	Indicator – High Brightness	9.2	Yellow
3553	Indicator – General Purpose	1.6	Tinted Diffused Wide Angle
3554	Indicator – High Brightness	6.7	Green
3567	General Purpose Point Source	4.2	Tinted Non-diffused Narrow Angle
3568	Indicator – High Brightness	10.6	Green

High Efficiency Red HLMP-335X/-336X Series Electrical Specifications at $T_A = 25^\circ\text{C}$

Symbol	Description	Device HLMP-	Min.	Typ.	Max.	Units	Test Conditions
I_V	Axial Luminous Intensity	3350 3351 3365 3366	2.1 5.4 8.6 13.8	3.5 7.0 10.0 18.0		mcd	$I_F = 10\text{ mA}$ (Figure 8)
$2\theta^{1/2}$	Including Angle Between Half Luminous Intensity Points	3350 3351 3365 3366		50 50 45 45		Deg.	Note 1 (Figure 11)
λ_{PEAK}	Peak Wavelength			635		nm	Measurement at Peak (Figure 1)
λ_d	Dominant Wavelength			626		nm	Note 2
$\Delta\lambda_{1/2}$	Spectral Line Halfwidth			40		nm	
τ_s	Speed of Response			90		ns	
C	Capacitance			11		pF	$V_F = 0$; $f = 1\text{ MHz}$
$R\theta_{\text{J-PIN}}$	Thermal Resistance			260		$^\circ\text{C/W}$	Junction to Cathode Lead
V_F	Forward Voltage			1.9	2.4	V	$I_F = 10\text{ mA}$ (Figure 7)
V_R	Reverse Breakdown Voltage		5.0			V	$I_R = 100\ \mu\text{A}$
η_V	Luminous Efficacy			145		lm/W	Note 3

Notes:

- $\theta^{1/2}$ is the off-axis angle at which the luminous intensity is half the axial luminous intensity.
- Dominant wavelength, λ_d , is derived from the CIE chromaticity diagram and represents the single wavelength which defines the color of the device.
- Radiant Intensity, I_e , in watts/steradian may be found from the equation $I_e = I_V/\eta_V$, where I_V is the luminous intensity in candelas and η_V is the luminous efficacy in lumens/watt.

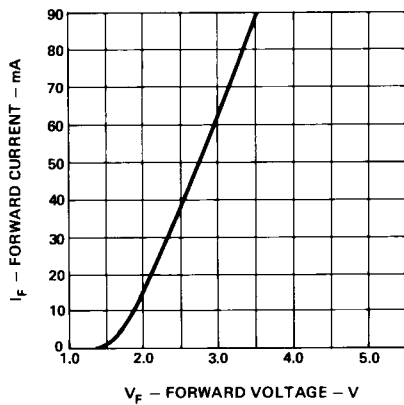

Figure 7. Forward Current vs. Forward Voltage.

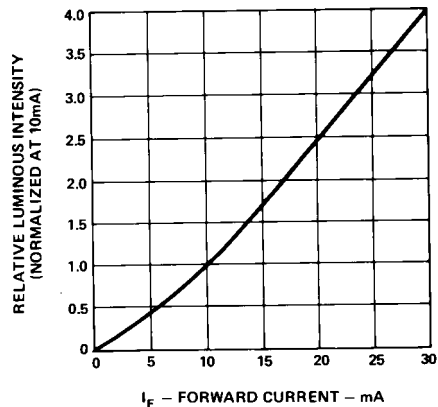

Figure 8. Relative Luminous Intensity vs. Forward Current.

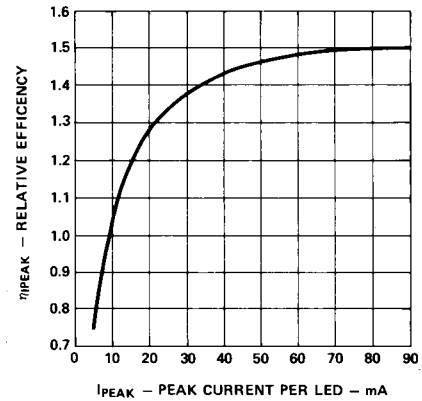

Figure 9. Relative Efficiency (Luminous Intensity per Unit Current) vs. Peak Current.

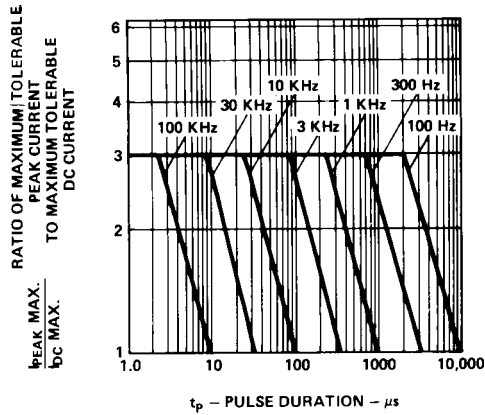

Figure 10. Maximum Tolerable Peak Current vs. Pulse Duration. (I_{DC} MAX as per MAX Ratings).

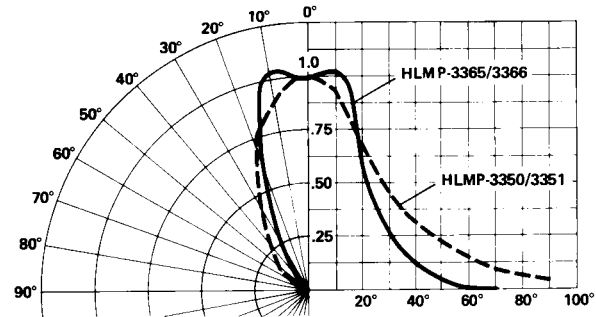

Figure 11. Relative Luminous Intensity vs. Angular Displacement.

Yellow HLMP-345X/-346X Series Electrical Specifications at $T_A = 25^\circ\text{C}$

Symbol	Description	Device HLMP-	Min.	Typ.	Max.	Units	Test Conditions
I_V	Axial Luminous Intensity	3450 3451 3465 3466	2.2 5.7 5.7 9.2	4.0 10.0 12.0 18.0		mcd	$I_F = 10$ mA (Figure 13)
$2\theta_{1/2}$	Including Angle Between Half Luminous Intensity Points	3450 3451 3465 3466		50 50 45 45		Deg.	Note 1 (Figure 16)
λ_{PEAK}	Peak Wavelength			583		nm	Measurement at Peak (Figure 1)
λ_d	Dominant Wavelength			585		nm	Note 2
$\Delta\lambda_{1/2}$	Spectral Line Halfwidth			36		nm	
τ_s	Speed of Response			90		ns	
C	Capacitance			15		pF	$V_F = 0$; $f = 1$ MHz
$R\theta_{J-PIN}$	Thermal Resistance			260		$^\circ\text{C}/\text{W}$	Junction to Cathode Lead
V_F	Forward Voltage			2.0	2.4	V	$I_F = 10$ mA (Figure 12)
V_R	Reverse Breakdown Voltage		5.0			V	$I_R = 100$ μA
η_V	Luminous Efficacy			500		lm/W	Note 3

Notes:

- $\theta_{1/2}$ is the off-axis angle at which the luminous intensity is half the axial luminous intensity.
- Dominant wavelength, λ_d , is derived from the CIE chromaticity diagram and represents the single wavelength which defines the color of the device.
- Radiant Intensity, I_e , in watts/steradian may be found from the equation $I_e = I_V/\eta_V$, where I_V is the luminous intensity in candelas and η_V is the luminous efficacy in lumens/watt.

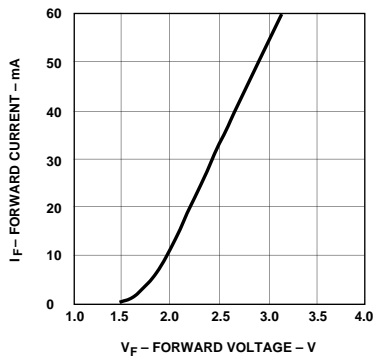

Figure 12. Forward Current vs. Forward Voltage.

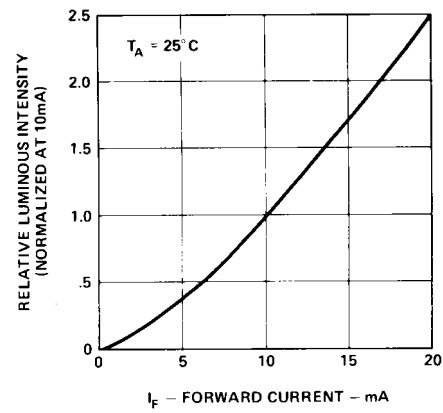

Figure 13. Relative Luminous Intensity vs. Forward Current.

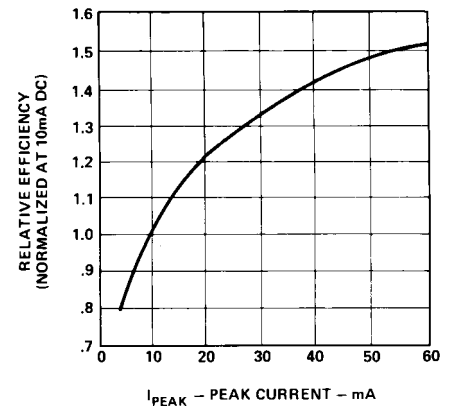

Figure 14. Relative Efficiency (Luminous Intensity per Unit Current) vs. Peak Current.

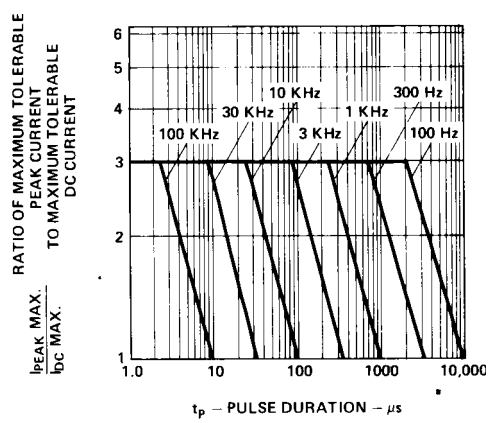

Figure 15. Maximum Tolerable Peak Current vs. Pulse Duration. (I_{DC} MAX as per MAX Ratings).

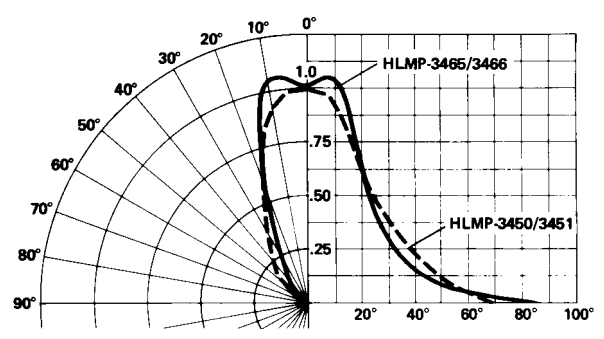

Figure 16. Relative Luminous Intensity vs. Angular Displacement.

Green HLMP-355X/-356X Series
Electrical Specifications at $T_A = 25^\circ\text{C}$

Symbol	Description	Device HLMP-	Min.	Typ.	Max.	Units	Test Conditions
I_V	Axial Luminous Intensity	3553 3554 3567 3568	1.6 6.7 4.2 10.6	3.2 10.0 7.0 15.0		mcd	$I_F = 10\text{ mA}$ (Figure 18)
$2\theta_{1/2}$	Including Angle Between Half Luminous Intensity Points	3553 3554 3567 3568		50 50 40 40		Deg.	Note 1 (Figure 21)
λ_{PEAK}	Peak Wavelength			565		nm	Measurement at Peak (Figure 1)
λ_d	Dominant Wavelength			569		nm	Note 2
$\Delta\lambda_{1/2}$	Spectral Line Halfwidth			28		nm	
τ_s	Speed of Response			500		ns	
C	Capacitance			18		pF	$V_F = 0$; $f = 1\text{ MHz}$
$R\theta_{\text{J-PIN}}$	Thermal Resistance			260		$^\circ\text{C/W}$	Junction to Cathode Lead
V_F	Forward Voltage			2.1	2.7	V	$I_F = 10\text{ mA}$ (Figure 17)
V_R	Reverse Breakdown Voltage		5.0			V	$I_R = 100\ \mu\text{A}$
η_V	Luminous Efficacy			595		lm/W	Note 3

Notes:

- $\theta_{1/2}$ is the off-axis angle at which the luminous intensity is half the axial luminous intensity.
- Dominant wavelength, λ_d , is derived from the CIE chromaticity diagram and represents the single wavelength which defines the color of the device.
- Radiant Intensity, I_e , in watts/steradian may be found from the equation $I_e = I_V/\eta_V$, where I_V is the luminous intensity in candelas and η_V is the luminous efficacy in lumens/watt.

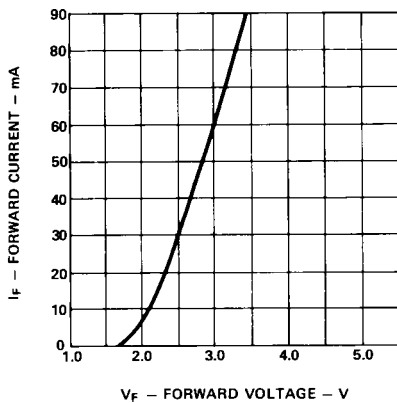

Figure 17. Forward Current vs. Forward Voltage.

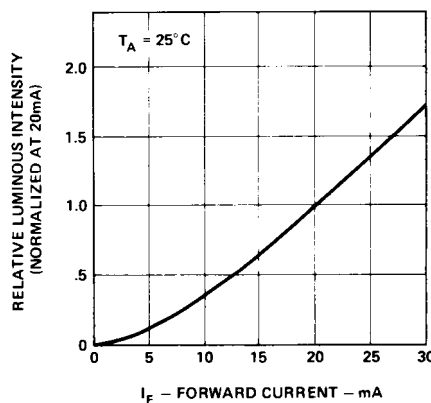

Figure 18. Relative Luminous Intensity vs. Forward Current.

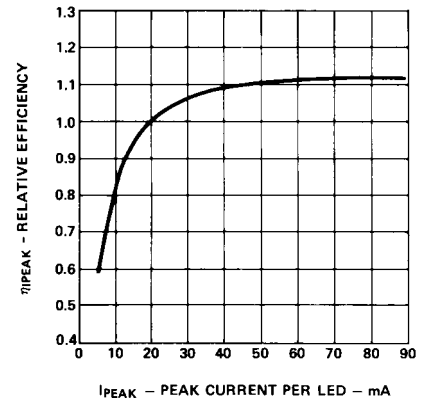

Figure 19. Relative Efficiency (Luminous Intensity per Unit Current) vs. Peak Current.

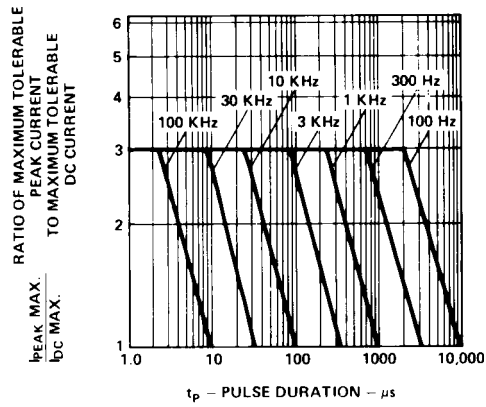

Figure 20. Maximum Tolerable Peak Current vs. Pulse Duration. (I_{DC} MAX as per MAX Ratings).

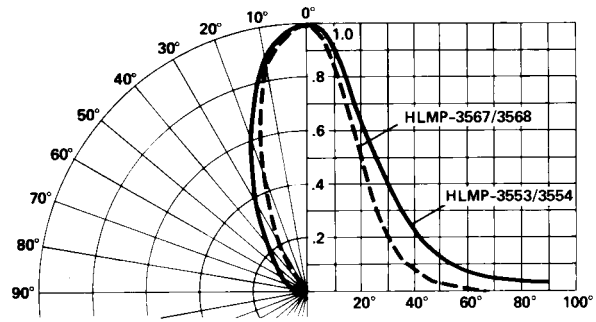

Figure 21. Relative Luminous Intensity vs. Angular Displacement.