

# Component General, Inc.

## Coaxial Attenuators

### MECHANICAL SPECIFICATIONS

Connector: Brass, Nickel Plated.  
Housing: Aluminum, Nickel Plated per QQ-N-290.  
Insulator: PTFE, Virgin grade.  
Impedance: 50  $\Omega$ .

www.DataSheet4U.com

high power coaxial attenuators product selection chart				
P/N	Connectors	Width	Height	Thickness
CHA-20 SM	SMA Male	1.770"	1.000"	0.500"
CHA-20 SF	SMA Female	1.500"	1.000"	0.500"
CHA-20 SMF	SMA Male & Female	1.635"	1.000"	0.500"
CHA-20 NM	N Male	2.640"	1.000"	1.025"
CHA-20 NF	N Female	2.520"	1.000"	1.025"
CHA-20 NMF	N Male & Female	2.580"	1.000"	2.580"

# Component General, Inc.

P/N:CHA-20 SF

## Coaxial Attenuators

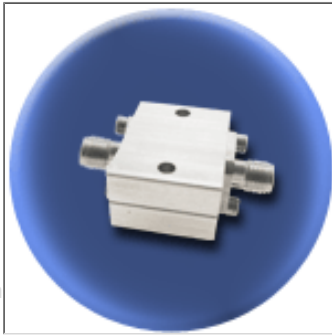

### Attenuation Accuracy:

dB	DC - 1 GHz	1 - 2.5 GHz	2.5 - 4 GHz
1 - 5	± 0.5	± 0.5	± 0.5
6 - 9	± 0.5	± 0.5	± 1.0
10 - 15	± 0.75	± 1.0	± 1.5
16 - 20	± 1.0	± 2.0	± 3.0

### Mechanical Specifications

#### Connector:

Brass, Nickel plated.

#### Housing:

Aluminum, Nickel plated per QQ-N-290.

#### Insulator:

PTFE, Virgin grade. .

### Environmental Specifications

#### Temperature Range:

-33° to +55° C (Operating with adequate heat sink)

#### Relative Humidity:

0 to 95% (Non-condensing)

### Electrical Specifications

#### Input Power :

20 W. (CW,Max.)

#### Impedance:

50 Ω

#### Frequency Range:

DC - 1.0 GHz

1.0 - 2.5 GHz

2.5 - 4.0 GHz

#### VSWR (Max.):

1.15:1

1.35:1

1.50:1

**Note: The power ratings are based on a maximum base temperature of 85° C, and derated linearly to zero at 150° C. The use of thermal mounting compound is recommended.**

### Part Dimensions

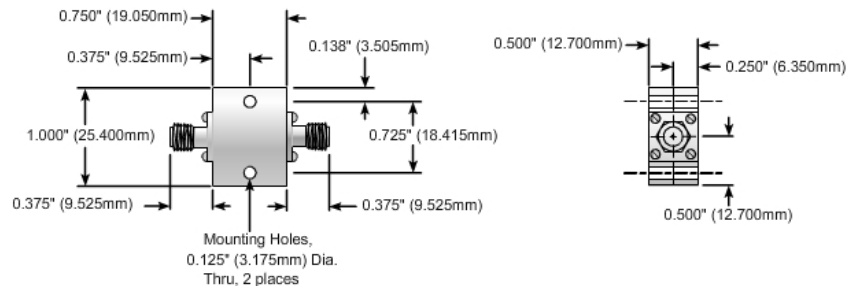

# Component General, Inc.

P/N:CHA-20 SM

## Coaxial Attenuators

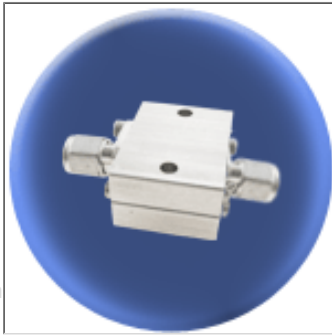

### Attenuation Accuracy:

dB	DC - 1 GHz	1 - 2.5 GHz	2.5 - 4 GHz
1 - 5	± 0.5	± 0.5	± 0.5
6 - 9	± 0.5	± 0.5	± 1.0
10 - 15	± 0.75	± 1.0	± 1.5
16 - 20	± 1.0	± 2.0	± 3.0

### Mechanical Specifications

#### Connector:

Brass, Nickel plated.

#### Housing:

Aluminum, Nickel plated per QQ-N-290.

#### Insulator:

PTFE, Virgin grade. .

### Environmental Specifications

#### Temperature Range:

-33° to +55° C (Operating with adequate heat sink)

#### Relative Humidity:

0 to 95% (Non-condensing)

### Electrical Specifications

#### Input Power :

20 W. (CW,Max.)

#### Impedance:

50 Ω

#### Frequency Range:

DC - 1.0 GHz

1.0 - 2.5 GHz

2.5 - 4.0 GHz

#### VSWR (Max.):

1.15:1

1.35:1

1.50:1

**Note:** The power ratings are based on a maximum base temperature of 85° C, and derated linearly to zero at 150° C. The use of thermal mounting compound is recommended.

### Part Dimensions

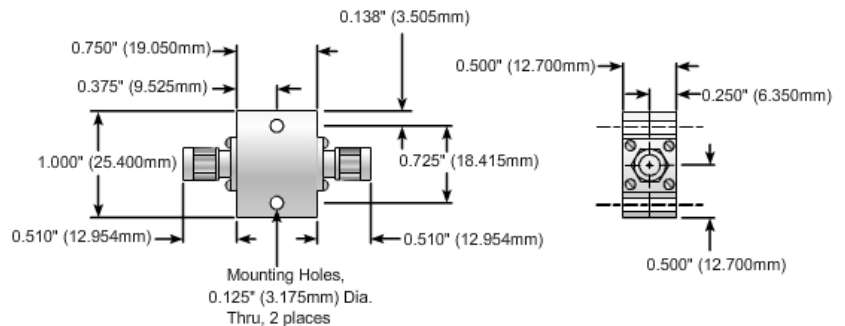

# Component General, Inc.

P/N:CHA-20 SMF

## Coaxial Attenuators

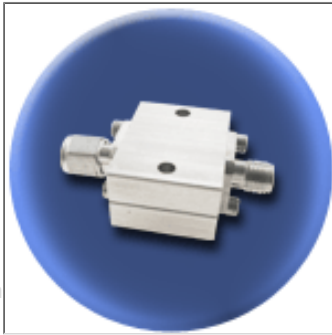

### Attenuation Accuracy:

dB	DC - 1 GHz	1 - 2.5 GHz	2.5 - 4 GHz
1 - 5	± 0.5	± 0.5	± 0.5
6 - 9	± 0.5	± 0.5	± 1.0
10 - 15	± 0.75	± 1.0	± 1.5
16 - 20	± 1.0	± 2.0	± 3.0

### Mechanical Specifications

#### Connector:

Brass, Nickel plated.

#### Housing:

Aluminum, Nickel plated per QQ-N-290.

#### Insulator:

PTFE, Virgin grade.

### Environmental Specifications

#### Temperature Range:

-33° to +55° C (Operating with adequate heat sink)

#### Relative Humidity:

0 to 95% (Non-condensing)

### Electrical Specifications

#### Input Power :

20 W. (CW,Max.)

#### Impedance:

50 Ω

#### Frequency Range:

DC - 1.0 GHz

1.0 - 2.5 GHz

2.5 - 4.0 GHz

#### VSWR (Max.):

1.15:1

1.35:1

1.50:1

**Note: The power ratings are based on a maximum base temperature of 85° C, and derated linearly to zero at 150° C. The use of thermal mounting compound is recommended.**

### Part Dimensions

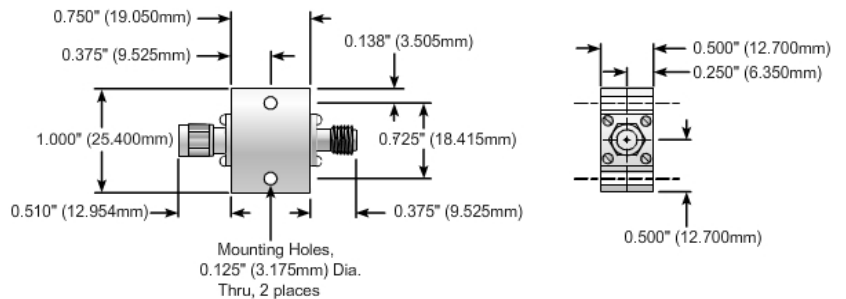

# Component General, Inc.

P/N:CHA-20 NF

## Coaxial Attenuators

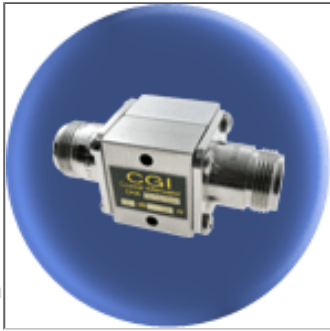

### Attenuation Accuracy:

dB	DC - 1 GHz	1 - 2.5 GHz	2.5 - 4 GHz
1 - 5	± 0.5	± 0.5	± 0.5
6 - 9	± 0.5	± 0.5	± 1.0
10 - 15	± 0.75	± 1.0	± 1.5
16 - 20	± 1.0	± 2.0	± 3.0

### Mechanical Specifications

#### Connector:

Brass, Nickel plated.

#### Housing:

Aluminum, Nickel plated per QQ-N-290.

#### Insulator:

PTFE, Virgin grade.

### Environmental Specifications

#### Temperature Range:

-33° to +55° C (Operating with adequate heat sink)

#### Relative Humidity:

0 to 95% (Non-condensing)

### Electrical Specifications

#### Input Power :

20 W. (CW,Max.)

#### Impedance:

50 Ω

#### Frequency Range:

DC - 1.0 GHz

1.0 - 2.5 GHz

2.5 - 4.0 GHz

#### VSWR (Max.):

1.15:1

1.35:1

1.50:1

**Note: The power ratings are based on a maximum base temperature of 85° C, and derated linearly to zero at 150° C. The use of thermal mounting compound is recommended.**

### Part Dimensions

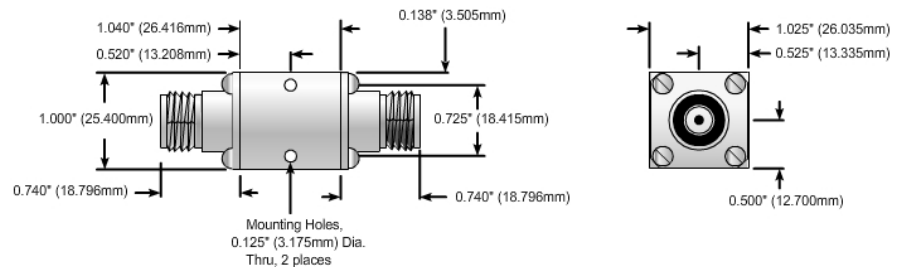

# Component General, Inc.

P/N:CHA-20 NM

## Coaxial Attenuators

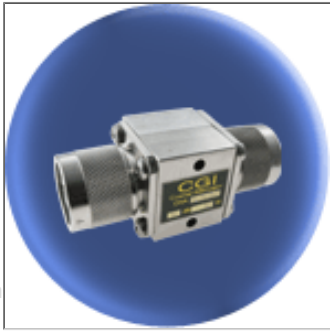

### Attenuation Accuracy:

dB	DC - 1 GHz	1 - 2.5 GHz	2.5 - 4 GHz
1 - 5	± 0.5	± 0.5	± 0.5
6 - 9	± 0.5	± 0.5	± 1.0
10 - 15	± 0.75	± 1.0	± 1.5
16 - 20	± 1.0	± 2.0	± 3.0

### Mechanical Specifications

#### Connector:

Brass, Nickel plated.

#### Housing:

Aluminum, Nickel plated per QQ-N-290.

#### Insulator:

PTFE, Virgin grade. .

### Environmental Specifications

#### Temperature Range:

-33° to +55° C (Operating with adequate heat sink)

#### Relative Humidity:

0 to 95% (Non-condensing)

### Electrical Specifications

#### Input Power :

20 W. (CW,Max.)

#### Impedance:

50 Ω

#### Frequency Range:

DC - 1.0 GHz

1.0 - 2.5 GHz

2.5 - 4.0 GHz

#### VSWR (Max.):

1.15:1

1.35:1

1.50:1

**Note: The power ratings are based on a maximum base temperature of 85° C, and derated linearly to zero at 150° C. The use of thermal mounting compound is recommended.**

### Part Dimensions

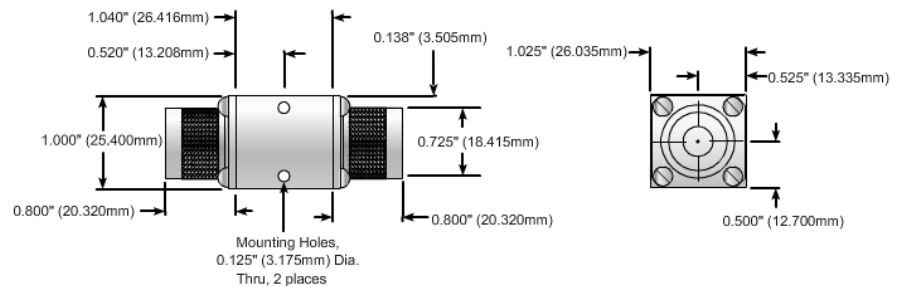

2445 Success Drive Odessa, FL 33556  
727-376-6655 or 800-246-4084

# Component General, Inc.

P/N:CHA-20 NMF

## Coaxial Attenuators

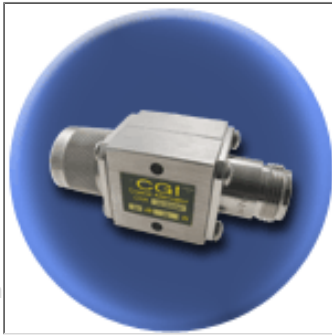

### Attenuation Accuracy:

dB	DC - 1 GHz	1 - 2.5 GHz	2.5 - 4 GHz
1 - 5	± 0.5	± 0.5	± 0.5
6 - 9	± 0.5	± 0.5	± 1.0
10 - 15	± 0.75	± 1.0	± 1.5
16 - 20	± 1.0	± 2.0	± 3.0

### Mechanical Specifications

#### Connector:

Brass, Nickel plated.

#### Housing:

Aluminum, Nickel plated per QQ-N-290.

#### Insulator:

PTFE, Virgin grade. .

### Environmental Specifications

#### Temperature Range:

-33° to +55° C (Operating with adequate heat sink)

#### Relative Humidity:

0 to 95% (Non-condensing)

### Electrical Specifications

#### Input Power :

20 W. (CW,Max.)

#### Impedance:

50 Ω

#### Frequency Range:

DC - 1.0 GHz

1.0 - 2.5 GHz

2.5 - 4.0 GHz

#### VSWR (Max.):

1.15:1

1.35:1

1.50:1

**Note: The power ratings are based on a maximum base temperature of 85° C, and derated linearly to zero at 150° C. The use of thermal mounting compound is recommended.**

### Part Dimensions

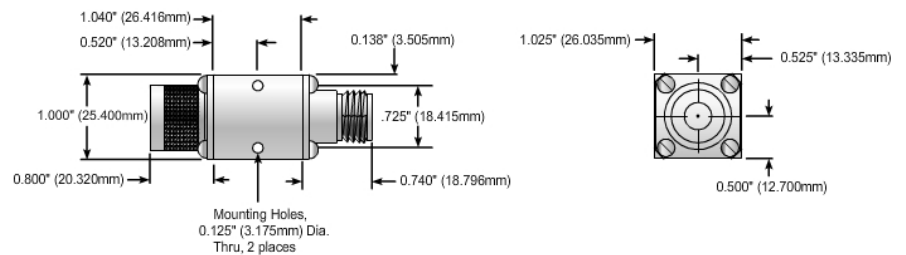

2445 Success Drive Odessa, FL 33556  
727-376-6655 or 800-246-4084