

# Cree® 5-mm Red and Amber Round LEDs

## C503B-RAS/RAN/AAS/AAN (15 degrees)

## C503B-RBS/RBN/ABS/ABN (23 degrees)

## C503B-RCS/RCN/ACS/ACN (30 degrees)

### Data Sheet

These round LED families offer superior light output for excellent readability in outdoor applications. The lamps are made with an advanced optical-grade epoxy that offers superior high-temperature and high-moisture resistance performance in outdoor sign and signal applications. The encapsulation resin contains UV inhibitors to minimize the effects of long-term exposure to direct sunlight, resulting in stable light output over the life of the LED.

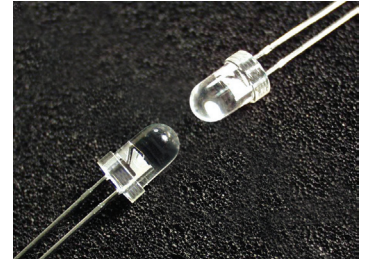

#### FEATURES

- Size (mm): 5
- Color and Typical Dominant Wavelength (nm):
  - » Red (624)
  - » Amber (591)
- Luminous Intensity (mcd)
  - » C503B-RAS/RAN (5860 - 23500)
  - » C503B-RBS/RBN (3000 - 12000)
  - » C503B-RCS/RCN (3000 - 12000)
  - » C503B-AAS/AAN (5860 - 23500)
  - » C503B-ACS/ACN (3000 - 8200)
  - » C503B-ABS/ABN (3000 - 12000)
- Viewing angle:
  - » C503B-RAS/RAN/AAS/AAN: 15 degree
  - » C503B-RBS/RBN/ABS/ABN: 23 degree
  - » C503B-RCS/RCN/ACS/ACN: 30 degree
- Lead-Free
- RoHS-Compliant

#### APPLICATIONS

- Electronic Signs & Signals (ESS)
- Motorway Signs
- Variable-Message Sign (VMS)
- Advertising Signs
- Petrol Signs
- Amusement



## Absolute Maximum Ratings ( $T_A = 25^\circ\text{C}$ )

Items	Symbol	Absolute Maximum Rating	Unit
		Red/Amber	
Forward Current	$I_F$	50 <sup>Note1</sup>	mA
Peak Forward Current <sup>Note2</sup>	$I_{FP}$	200	mA
Reverse Voltage	$V_R$	5	V
Power Dissipation	$P_D$	130	mW
Operation Temperature	$T_{opr}$	-40 ~ +95	°C
Storage Temperature	$T_{stg}$	-40 ~ +100	°C
Lead Soldering Temperature	$T_{sol}$	Max. 260°C for 3 sec. max. (3 mm from the base of the epoxy bulb)	
Electrostatic Discharge Classification (MIL-STD-883E)	ESD	Class 2	

### Note:

1. For long-term performance, the drive currents between 10 mA and 30 mA are recommended. Please contact a Cree sales representative for more information on recommended drive conditions.
2. Pulse width  $\leq 0.1$  msec, duty  $\leq 1/10$ .

## Typical Electrical & Optical Characteristics ( $T_A = 25^\circ\text{C}$ )

Characteristics	Color	Symbol	Condition	Unit	Minimum	Typical	Maximum
Forward Voltage	Red/Amber	$V_F$	$I_F = 20$ mA	V		2.1	2.6
Reverse Current	Red/Amber	$I_R$	$V_R = 5$ V	$\mu\text{A}$			100
Dominant Wave-length	Red	$\lambda_D$	$I_F = 20$ mA	nm	618	624	630
	Amber	$\lambda_D$	$I_F = 20$ mA	nm	584	591	596
Luminous Intensity	Red	C503B-RAS/RAN (15 degree)	$I_V$	$I_F = 20$ mA	mcd	5860	12000
		C503B-RBS/RBN (23 degree)	$I_V$	$I_F = 20$ mA	mcd	3000	5000
		C503B-RCS/RCN (30 degree)	$I_V$	$I_F = 20$ mA	mcd	3000	5100
	Amber	C503B-AAS/AAN (15 degree)	$I_V$	$I_F = 20$ mA	mcd	5860	13000
		C503B-ABS/ABN (23 degree)	$I_V$	$I_F = 20$ mA	mcd	3000	5000
		C503B-ACS/ACN (30 degree)	$I_V$	$I_F = 20$ mA	mcd	3000	5000
50% Power Angle	C503B-RAS/RAN/AAS/AAN		$2\theta_{1/2}$	$I_F = 20$ mA	deg	15	
	C503B-RBS/RBN/ABS/ABN		$2\theta_{1/2}$	$I_F = 20$ mA	deg	23	
	C503B-RCS/RCN/ACS/ACN		$2\theta_{1/2}$	$I_F = 20$ mA	deg	30	

## Intensity Bin Limit ( $I_f = 20 \text{ mA}$ )

Red

C503B-RAS/RAN (15 degree)

Bin Code	Min. (mcd)	Max. (mcd)
Y0	5860	8200
Z0	8200	12000
A0	12000	16800
B0	16800	23500

C503B-RBS/RBN (23 degree)

Bin Code	Min. (mcd)	Max. (mcd)
W0	3000	4180
X0	4180	5860
Y0	5860	8200
Z0	8200	12000

C503B-RCS/RCN (30 degree)

Bin Code	Min. (mcd)	Max. (mcd)
W0	3000	4180
X0	4180	5860
Y0	5860	8200
Z0	8200	12000

Amber

C503B-AAS/AAN (15 degree)

Bin Code	Min. (mcd)	Max. (mcd)
Y0	5860	8200
Z0	8200	12000
A0	12000	16800
B0	16800	23500

C503B-ABS/ABN (23 degree)

Bin Code	Min. (mcd)	Max. (mcd)
W0	3000	4180
X0	4180	5860
Y0	5860	8200
Z0	8200	12000

C503B-ACS/ACN (30 degree)

Bin Code	Min. (mcd)	Max. (mcd)
W0	3000	4180
X0	4180	5860
Y0	5860	8200

Tolerance of measurement of luminous intensity is  $\pm 15\%$

## Color Bin Limit ( $I_f = 20 \text{ mA}$ )

Red

Bin Code	Min. (nm)	Max. (nm)
RA	618	630

Amber

Bin Code	Min. (nm)	Max. (nm)
A2	584	587
A3	587	590
A4	590	593
A5	593	596

Tolerance of measurement of dominant wavelength is  $\pm 1 \text{ nm}$

# Graphs

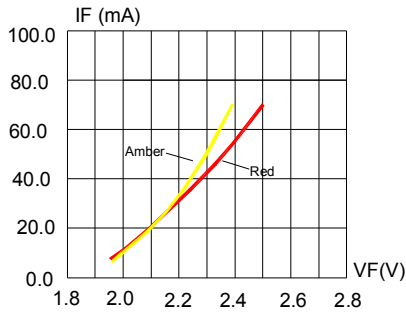

FIG. 1 FORWARD CURRENT VS. FORWARD VOLTAGE.

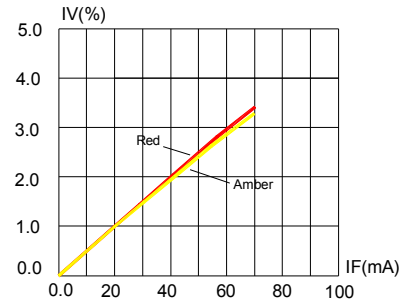

FIG. 2 RELATIVE LUMINOUS INTENSITY VS. FORWARD CURRENT

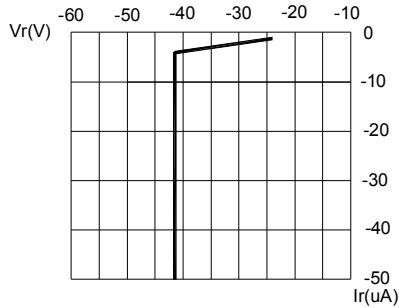

FIG. 3 RED & AMBER REVERSE CURRENT VS. REVERSE VOLTAGE.

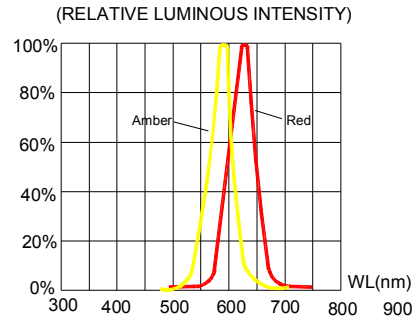

FIG. 4 RELATIVE LUMINOUS INTENSITY VS. WAVELENGTH.

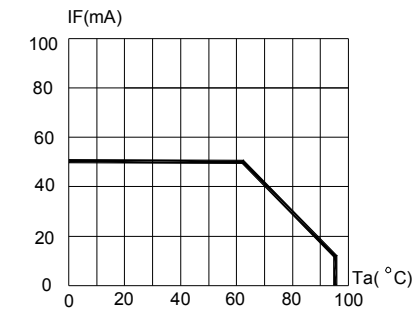

FIG. 5 RED & AMBER MAXIMUM FORWARD DCCURRENT VS AMBIENT TEMPERATURE (Tjmax=105°C)

# Graphs

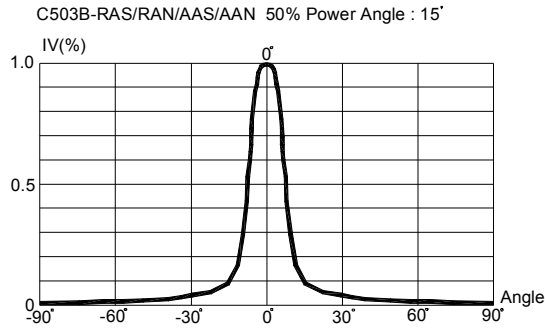

FIG.6 RED & AMBER FAR FIELD PATTERN

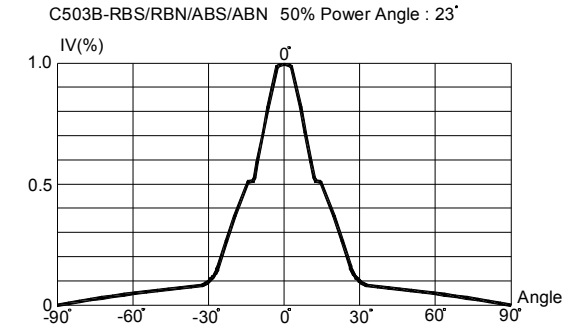

FIG.7 RED & AMBER FAR FIELD PATTERN

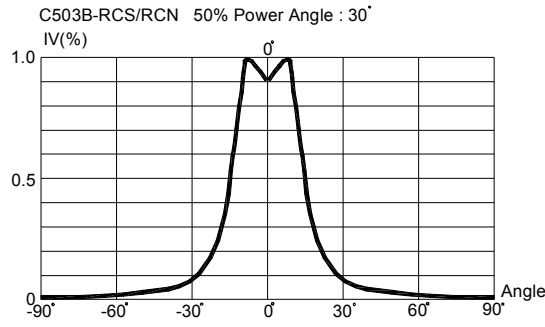

FIG.8 RED FAR FIELD PATTERN

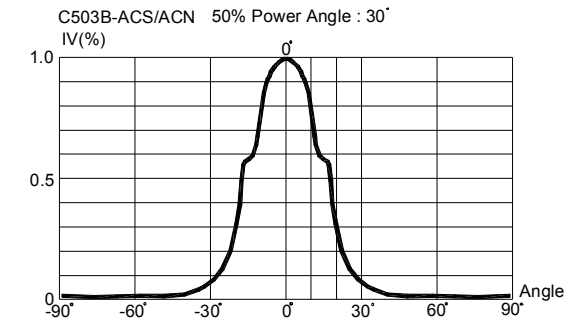

FIG.9 AMBER FAR FIELD PATTERN

## Mechanical Dimensions

All dimensions are in mm. Tolerance is  $\pm 0.25$  mm unless otherwise noted.

An epoxy meniscus may extend about 1.5 mm down the leads.

Burr around bottom of epoxy may be 0.5 mm max.

C503B-RAS/AAS:

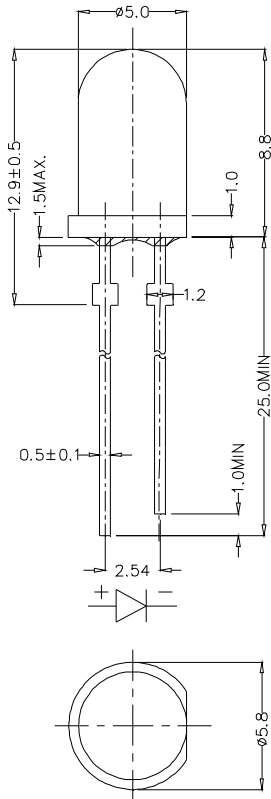

C503B-RBS/ABS:

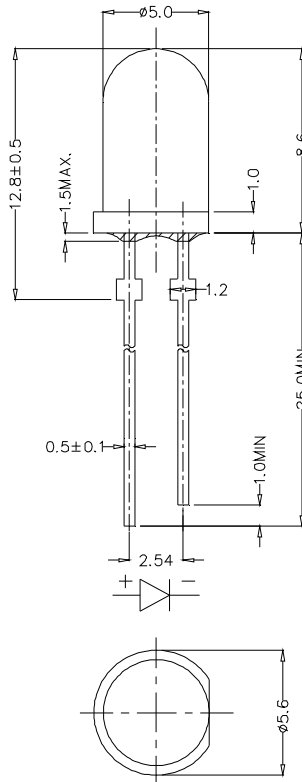

C503B-RCS:

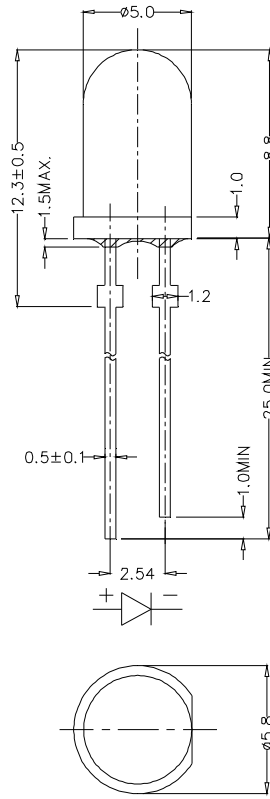

C503B-ACS:

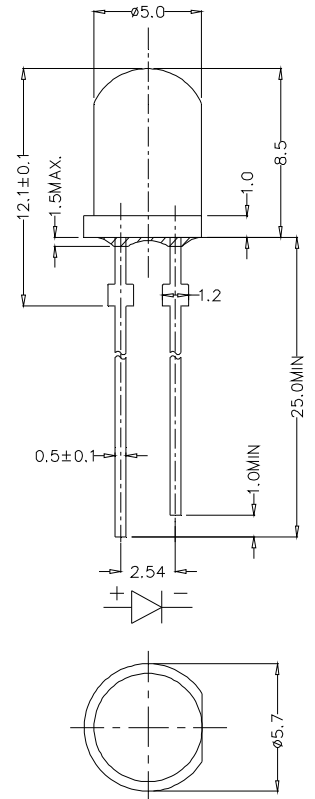

## Mechanical Dimensions

All dimensions are in mm. Tolerance is  $\pm 0.25$  mm unless otherwise noted.

An epoxy meniscus may extend about 1.5 mm down the leads.

Burr around bottom of epoxy may be 0.5 mm max.

C503B-RBN/ABN:

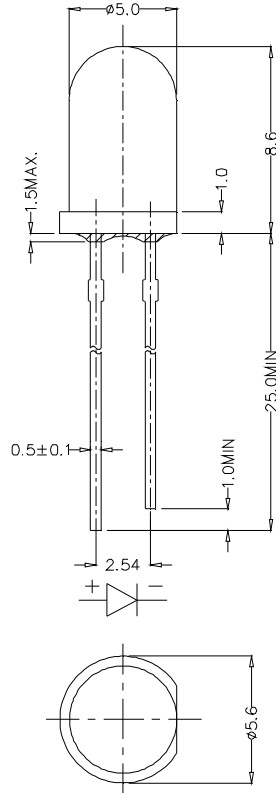

C503B-RAN/RCN/AAN/ACN:

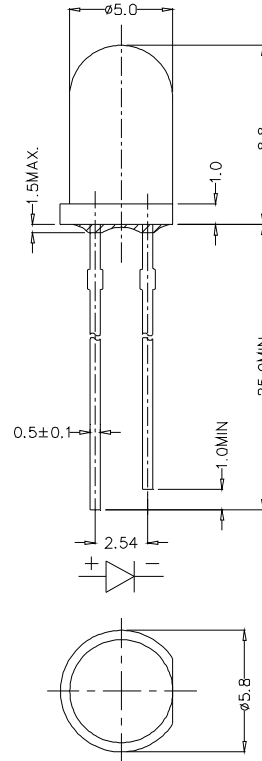

## Notes

### RoHS Compliance

The levels of environmentally sensitive, persistent biologically toxic (PBT), persistent organic pollutants (POP), or otherwise restricted materials in this product are below the maximum concentration values (also referred to as the threshold limits) permitted for such substances, or are used in an exempted application, in accordance with EU Directive 2002/95/EC on the restriction of the use of certain hazardous substances in electrical and electronic equipment (RoHS), as amended through April 21, 2006.

### Vision Advisory Claim

Users should be cautioned not to stare at the light of this LED product. The bright light can damage the eye.

## Package

### Features:

- The LEDs are packed in cardboard boxes after packaging in normal or anti-electrostatic bags.
- Cardboard boxes will be used to protect the LEDs from mechanical shock during transportation.
- The boxes are not water-resistant, and they must be kept away from water and moisture.
- The Bulk Pack types of packaging.
- Max 500 pcs per bulk and Max 2500 pcs per ammo.

### Bulk Pack Packaging Type:

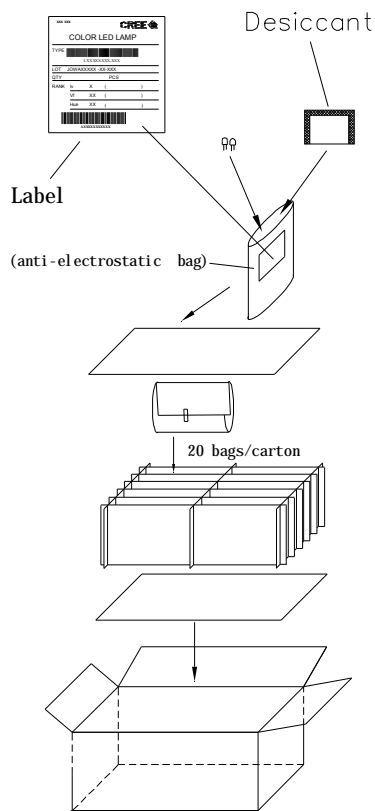

### Ammo Pack Packaging Type:

