

TOSHIBA Photocoupler GaAlAs Ired & Photo-Diode Array

# TLP590B

Telecommunication  
 Programmable Controllers  
 Mos Gate Driver  
 MOS FET Gate Driver

The TOSHIBA TLP590B consists of an aluminum gallium arsenide infrared emitting diode optically coupled to a series connected photo-diode array in a six lead plastic DIP package.  
 TLP590B is suitable for MOS FET gate driver.

- UL recognized: UL1577, file No. E67349

## Short Current

Type Name	Classification	Short Current		Marking Of Classification
		(min.)	I <sub>F</sub>	
TLP590B	C20	20μA	10mA	20
	Standard	12μA		20, blank

(Note) Application type name for certification test, please use standard product type name, i.e.

TLP590B(C20): TLP590B

## Maximum Ratings (Ta = 25°C)

Characteristics		Symbol	Rating	Unit
LED	Forward current	I <sub>F</sub>	50	mA
	Forward current derating (Ta ≥ 25°C)	ΔI <sub>F</sub> / °C	-0.5	mA / °C
	Pulse forward current (100μs pulse, 100 pps)	I <sub>FP</sub>	1	A
	Reverse voltage	V <sub>R</sub>	3	V
	Junction temperature	T <sub>j</sub>	125	°C
Detector	Foward current	I <sub>FD</sub>	50	μA
	Reverse voltage	V <sub>RD</sub>	10	V
	Junction temperature	T <sub>j</sub>	125	°C
Storage temperature range		T <sub>stg</sub>	-55~125	°C
Operating temperature range		T <sub>opr</sub>	-40~85	°C
Lead soldering temperature (10sec.)		T <sub>sol</sub>	260	°C
Isolation voltage (AC, 1 min., R.H. ≤ 60%) (Note 1)		BVS	2500	V <sub>rms</sub>

(Note 1) Device considered a two terminal device: Pins 1, 2 and 3 shorted together, and pins 4 and 6 shorted together.

Unit in mm

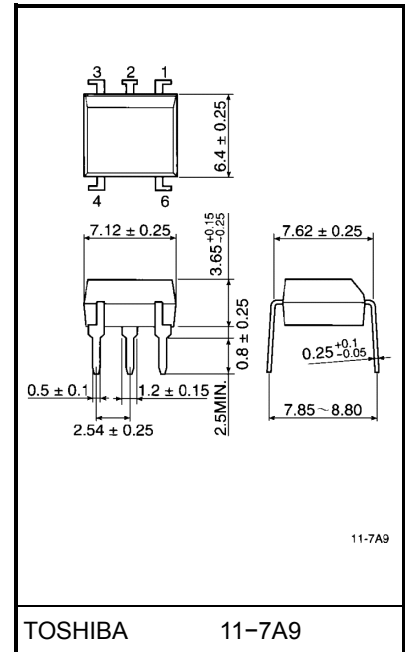

Weight: 0.39g

## Pin Configuration(top view)

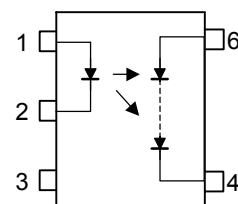

- 1. : Anode
- 2. : Cathode
- 3. : NC
- 4. : Cathode
- 6. : Anode

## Recommended Operating Conditions

Characteristic	Symbol	Min.	Typ.	Max.	Unit
Forward current	$I_F$	—	20	25	mA
Operating temperature	$T_{opr}$	-25	—	85	°C

## Individual Electrical Characteristics (Ta = 25°C)

Characteristic		Symbol	Test Condition	Min.	Typ.	Max.	Unit
LED	Forward voltage	$V_F$	$I_F = 10 \text{ mA}$	1.2	1.4	1.7	V
	Reverse current	$I_R$	$V_R = 3 \text{ V}$	—	—	10	$\mu\text{A}$
	Capacitance	$C_T$	$V = 0, f = 1 \text{ MHz}$	—	30	60	pF
Detector	Forward voltage	$V_{FD}$	$I_{FD} = 10 \mu\text{A}$	—	7	—	V
	Reverse current	$I_{RD}$	$V_{RD} = 10 \text{ V}$	—	1	—	nA
	Capacitance (anode to cathode)	$C_{TD}$	$V = 0, f = 1 \text{ MHz}$	—	—	—	pF

## Coupled Electrical Characteristics (Ta = 25°C)

Characteristic	Symbol	Test Condition	Min.	Typ.	Max.	Unit
Open voltage	$V_{OC}$	$I_F = 10 \text{ mA}$	7.0	8.0	—	V
Short current	$I_{SC}$	$I_F = 10 \text{ mA}$	12	20	—	$\mu\text{A}$

## Isolation Characteristics (Ta = 25°C)

Characteristic	Symbol	Test Condition	Min.	Typ.	Max.	Unit
Capacitance input to output	$C_S$	$V_S = 0, f = 1 \text{ MHz}$	—	0.8	—	pF
Isolation resistance	$R_S$	$V_S = 500 \text{ V}, \text{R.H.} \leq 60\%$	$5 \times 10^{10}$	$10^{14}$	—	$\Omega$
Isolation voltage	$BV_S$	AC, 1 minute	2500	—	—	Vrms
		AC, 1 second in oil	—	5000	—	—
		DC, 1 minute in oil	—	5000	—	Vdc

## Switching Characteristics (Ta = 25°C)

Characteristic	Symbol	Test Condition	Min.	Typ.	Max.	Unit
Turn-on time	$t_{on}$	$I_F = 20 \text{ mA}, R_{SH} = 510 \text{ k}\Omega$ $C_L = 1000 \text{ pF}$ (Fig.1)	—	0.2	—	ms
Turn-off time	$t_{off}$		—	1	—	ms

Fig. 1 Switching time test circuit

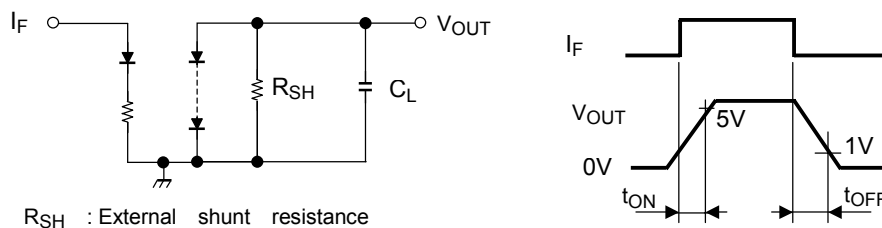

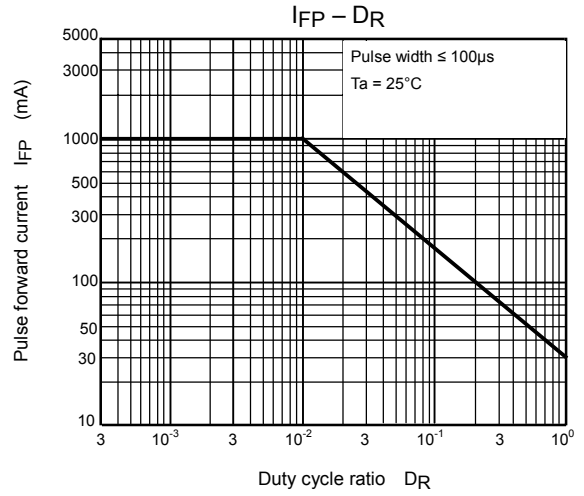
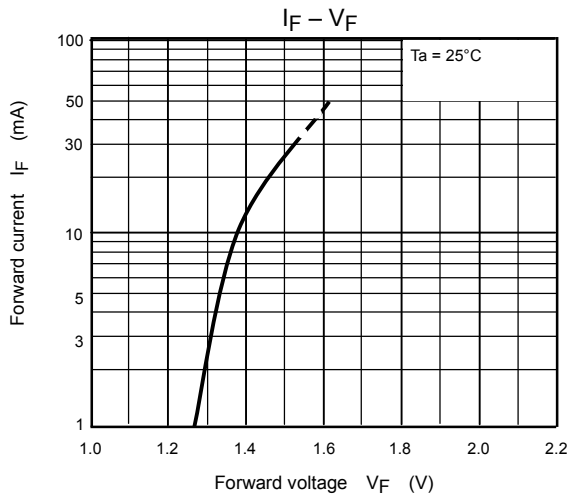
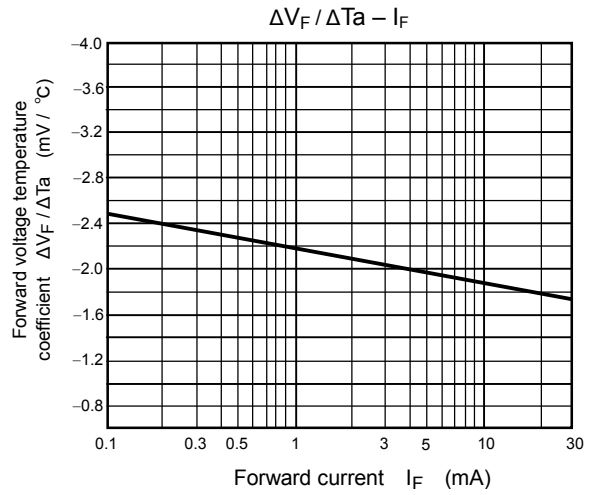
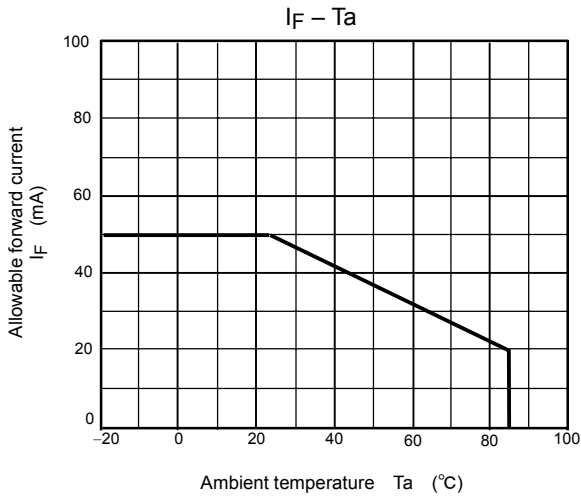

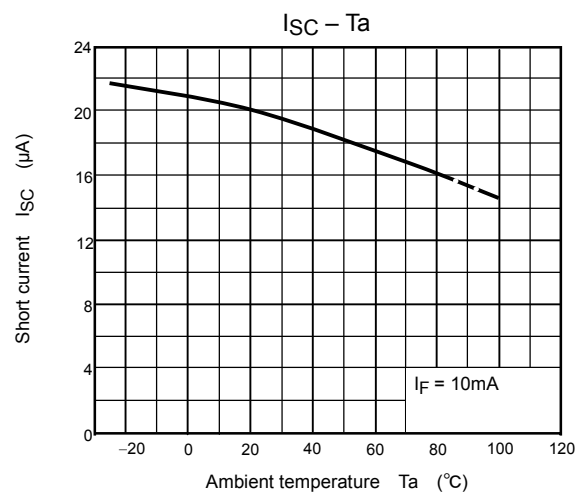
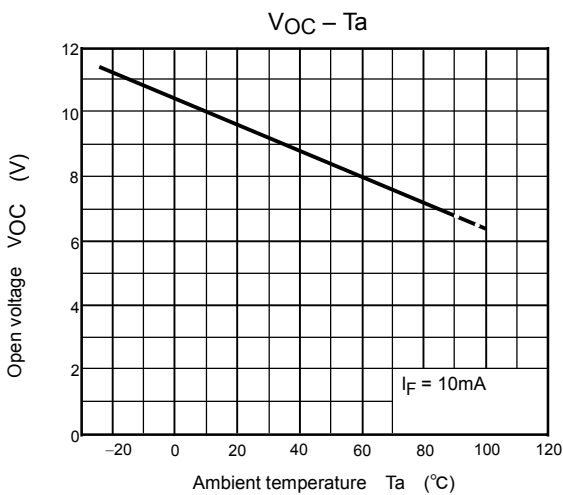
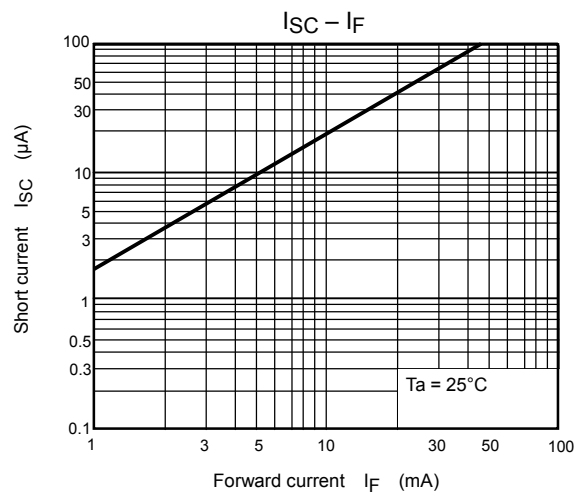
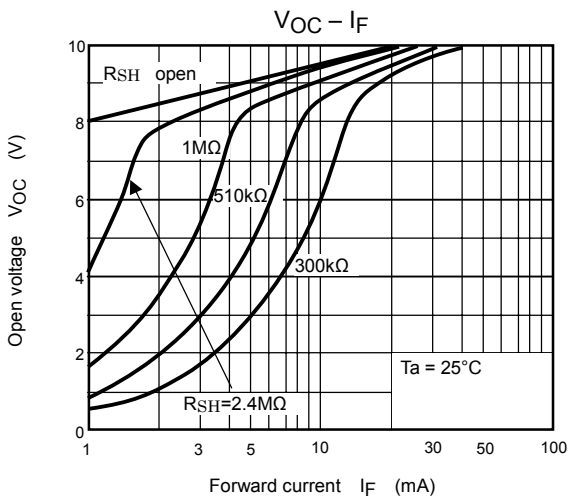
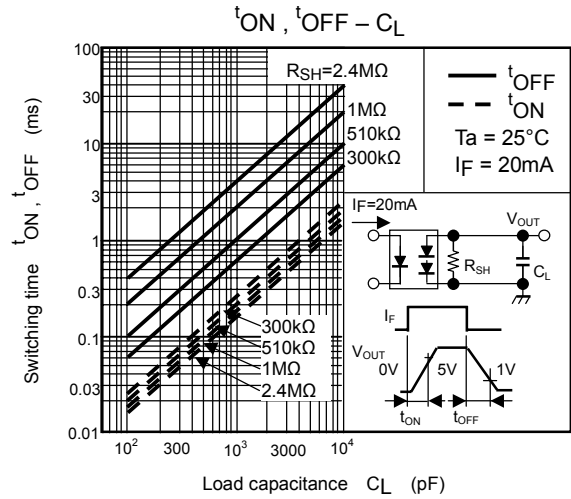
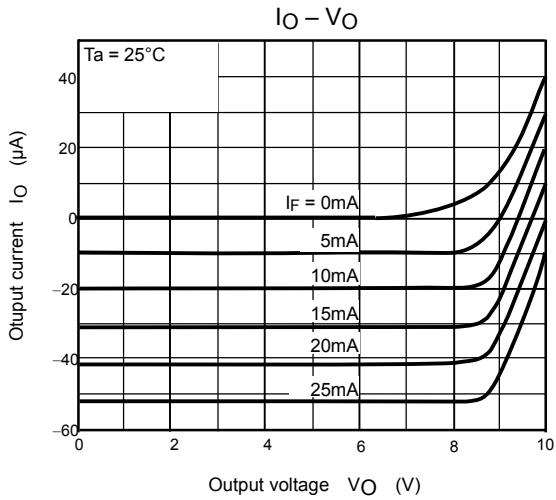

**RESTRICTIONS ON PRODUCT USE**

000707EBC

- TOSHIBA is continually working to improve the quality and reliability of its products. Nevertheless, semiconductor devices in general can malfunction or fail due to their inherent electrical sensitivity and vulnerability to physical stress. It is the responsibility of the buyer, when utilizing TOSHIBA products, to comply with the standards of safety in making a safe design for the entire system, and to avoid situations in which a malfunction or failure of such TOSHIBA products could cause loss of human life, bodily injury or damage to property.  
In developing your designs, please ensure that TOSHIBA products are used within specified operating ranges as set forth in the most recent TOSHIBA products specifications. Also, please keep in mind the precautions and conditions set forth in the "Handling Guide for Semiconductor Devices," or "TOSHIBA Semiconductor Reliability Handbook" etc..
- The TOSHIBA products listed in this document are intended for usage in general electronics applications (computer, personal equipment, office equipment, measuring equipment, industrial robotics, domestic appliances, etc.). These TOSHIBA products are neither intended nor warranted for usage in equipment that requires extraordinarily high quality and/or reliability or a malfunction or failure of which may cause loss of human life or bodily injury ("Unintended Usage"). Unintended Usage include atomic energy control instruments, airplane or spaceship instruments, transportation instruments, traffic signal instruments, combustion control instruments, medical instruments, all types of safety devices, etc.. Unintended Usage of TOSHIBA products listed in this document shall be made at the customer's own risk.
- Gallium arsenide (GaAs) is a substance used in the products described in this document. GaAs dust and fumes are toxic. Do not break, cut or pulverize the product, or use chemicals to dissolve them. When disposing of the products, follow the appropriate regulations. Do not dispose of the products with other industrial waste or with domestic garbage.
- The products described in this document are subject to the foreign exchange and foreign trade laws.
- The information contained herein is presented only as a guide for the applications of our products. No responsibility is assumed by TOSHIBA CORPORATION for any infringements of intellectual property or other rights of the third parties which may result from its use. No license is granted by implication or otherwise under any intellectual property or other rights of TOSHIBA CORPORATION or others.
- The information contained herein is subject to change without notice.