

# AS1343

## 42V, 1-2 Cells, Micropower, DC-DC Boost Converter

### 1 General Description

The AS1343 boost converter contains a 1.4A internal switch in a tiny TDFN-10 3x3mm package. The device operates from a 0.9V to 3.6V supply, and can boost voltages up to 42V output.

The output voltage can easily be adjusted by an external resistor divider.

The AS1343 uses a unique control scheme providing the highest efficiency over a wide range of load conditions. An internal 1.4A MOSFET reduces external component count, and a fixed high switching frequency (1MHz) allows for tiny surface-mount components.

The AS1343 also features power-OK circuitry which monitors the output voltage.

Additionally the AS1343 features a low quiescent supply current and a shutdown mode to save power. During shutdown an output disconnect switch separates the input from the output.

The AS1343 is ideal for LCD or OLED panels with low current requirements and can also be used in a wide range of other applications.

The device is available in a low-profile TDFN-10 3x3mm package.

### 2 Key Features

- 5.5V to 42V Adjustable Output Voltage
- 0.9V to 3.6V Supply Voltage Range
- High Output Currents:
  - 30mA @ 12V VOUT, from 1.5V VCC
  - 40mA @ 24V VOUT, from 2.5V VCC
- Efficiency: Up to 85%
- Switching Frequency: 1MHz
- Output Disconnect Function
- Output Discharge Function
- Power-OK Output
- Quiescent Current: 22µA
- Shutdown Current: 0.1µA
- TDFN-10 3x3mm Package

### 3 Applications

The device is ideal for OLED display power supply, LCD bias generators, mobile/cordless phones, palmtop computers, PDAs and organizers, handy terminals, driving LEDs or any other portable, battery-powered device.

Figure 1. AS1343 - Typical Application Diagram

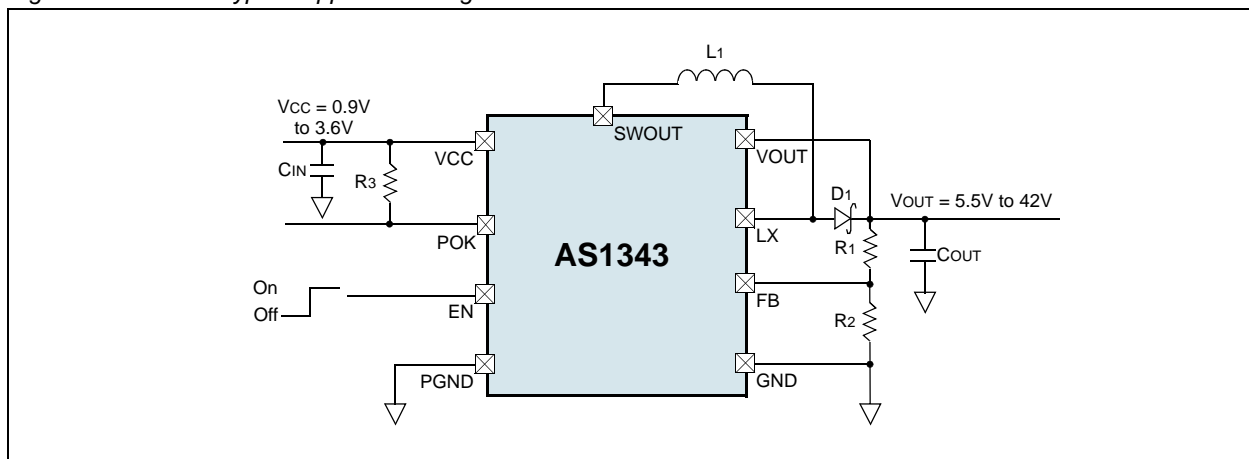

## 4 Pinout

### Pin Assignments

Figure 2. Pin Assignments (Top View)

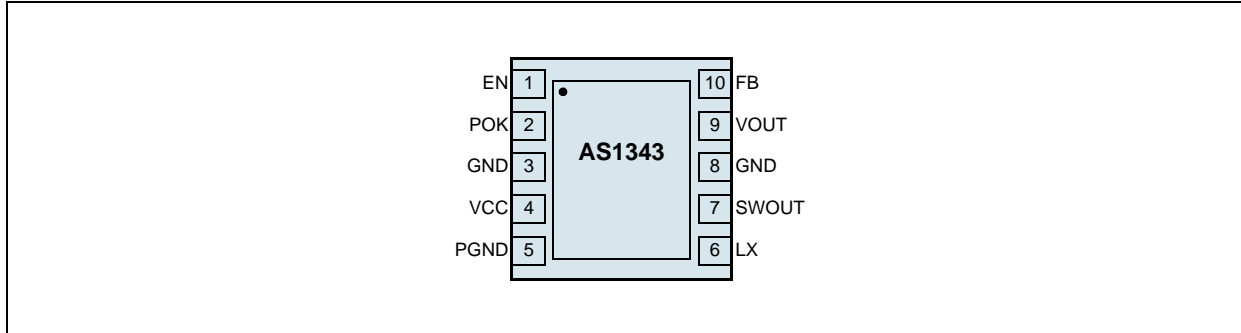

### Pin Descriptions

Table 1. Pin Descriptions

Pin Number	Pin Name	Description
1	EN	<b>Active-Low enable Input.</b> A logic low on this pin shuts down the device and reduces the supply current to 0.1µA. GND: device in shutdown. Vcc : normal operation.
2	POK	<b>Power-OK.</b> 0: VOUT < 90% of VOUTNOM. 1: VOUT > 90% of VOUTNOM.
3	GND	<b>Ground</b>
4	VCC	<b>+0.9V to +3.6V Supply Voltage.</b> Bypass this pin to GND with a ≥10µF capacitor.
5	PGND	<b>Ground.</b> Should be the starpoint of CIN and COUT.
6	LX	<b>Inductor.</b> The drain of the internal N-channel MOSFET. <b>Note:</b> This pin is high impedance in shutdown.
7	SWOUT	<b>Shutdown Disconnect Switch Out.</b> Disconnects the input from the output during shutdown.
8	GND	<b>Ground</b>
9	VOUT	<b>+5.5 to +42V Output Voltage.</b> This pin also powers the AS1343 after startup. Bypass this pin to GND with a ≥4.7µF capacitor.
10	FB	<b>Feedback Pin.</b> Feedback input to the gm error amplifier. Connect a resistor divider tap to this pin. The output voltage can be adjusted from 5.5V to 42V by: $V_{OUT} = 1.25V[1 + (R_1/R_2)]$

## 5 Absolute Maximum Ratings

Stresses beyond those listed in [Table 2](#) may cause permanent damage to the device. These are stress ratings only, and functional operation of the device at these or any other conditions beyond those indicated in [Electrical Characteristics on page 4](#) is not implied. Exposure to absolute maximum rating conditions for extended periods may affect device reliability.

Table 2. Absolute Maximum Ratings

Parameter	Min	Max	Units	Comments
VCC, EN, SWOUT, POK, FB to GND		5	V	
VOUT, LX to GND		45		
Thermal Resistance $\Theta_{JA}$	36.7		°C/W	on PCB
ESD	2.5		kV	<i>HBM MIL-Std. 883E 3015.7 methods</i>
Latch-Up	-200	+150	mA	@25°C, JEDEC 78
Operating Temperature Range	-40	+85	°C	
Storage Temperature Range	-65	+150	°C	
Junction Temperature		125	°C	
Package Body Temperature		+260	°C	The reflow peak soldering temperature (body temperature) specified is in accordance with <i>IPC/JEDEC J-STD-020D "Moisture/Reflow Sensitivity Classification for Non-Hermetic Solid State Surface Mount Devices"</i> . The lead finish for Pb-free leaded packages is matte tin (100% Sn).

## 6 Electrical Characteristics

$V_{CC} = EN = 3.6V$ ,  $T_{AMB} = -40$  to  $+85^{\circ}C$  (unless otherwise specified). Typ values are at  $T_{AMB} = +25^{\circ}C$ .

Table 3. Electrical Characteristics

Symbol	Parameter	Condition	Min	Typ	Max	Unit
	Minimum Start-Up Voltage	$V_{OUT} = 12V$ , $I_{LOAD} = 1mA$		0.95	1	V
$V_{CC}$	Supply Voltage		0.9		3.6	V
$V_{OUT}$	Output Voltage Range		5.5		42	V
$I_Q$	Quiescent Current	$V_{OUT} = 6V$ , $V_{FB} = 1.3V$		22	30	$\mu A$
$I_{SHDN}$	Shutdown Current	$EN = GND$ , $T_{AMB} = +25^{\circ}C$		0.02	1	$\mu A$
		$EN = GND$			3	$\mu A$
$\Delta V_{LNR}$	Vcc Line Regulation	$V_{OUT} = 15V$ , $I_{LOAD} = 1mA$ , $V_{CC} = 1.8$ to $3.6V$		0.05		%/V
$\Delta V_{LDR}$	Load Regulation	$V_{OUT} = 15V$ , $I_{LOAD} = 0$ to $20mA$		0.01		%/mA
$\eta$	Efficiency	$L_1 = 6.8\mu H$ , $V_{OUT} = 12V$ , $I_{LOAD} = 50mA$		85		%
$V_{FB}$	Feedback Voltage		1.225	1.25	1.275	V
$I_{FB}$	Feedback Input Bias Current	$V_{FB} = 1.3V$		1	100	nA
<b>DC-DC Switches</b>						
$I_{LX(MAX)}$	LX Switch Current Limit			1.45		A
$R_{LX}$	NMOS Switch On-Resistance	$I_{LX} = 100mA$		0.9	1.5	$\Omega$
$R_{P\_ON}$	PMOS Switch On-Resistance	$I_{SWout} = -100mA$		0.3	1.0	
$I_{LX\_LEAK}$	LX Leakage Current	$V_{LX} = 42V$		15		nA
$I_{P\_LEAK}$	Switch Leakage Current	P-channel		10		
<b>Control Inputs</b>						
$V_{IH}$	EN Input Threshold	$0.9V \leq V_{CC} \leq 3.6V$	$0.8 \times V_{CC}$			V
$V_{IL}$					$0.2 \times V_{CC}$	
$I_{EN}$	EN Input Current	$V_{EN} = 0$ to $3.6V$		1		nA
<b>POK Output</b>						
$V_{OL}$	POK Output Low Voltage	POK sinking 1mA		0.01	0.2	V
	POK Output High Leakage Current	POK = 3.6V		1	500	nA
	POK Threshold	Falling edge, referenced to $V_{OUT(NOM)}$	87	90	93	%
<b>Oscillator</b>						
fCLK	Oscillator Frequency		0.85	1	1.15	MHz
	Maximum Duty Cycle		90	95		%

## 7 Typical Operating Characteristics

Parts used for measurements: 6.8 $\mu$ H (MOS6020-682) Inductor, 10 $\mu$ F (GRM21BR60J106KE19) C<sub>IN</sub> and 4.7 $\mu$ F (GRM32ER71H475KA88) C<sub>OUT</sub>, (PMEG4010BEA) D<sub>1</sub>;

Figure 3. Efficiency vs. Output Current; V<sub>OUT</sub> = 6V

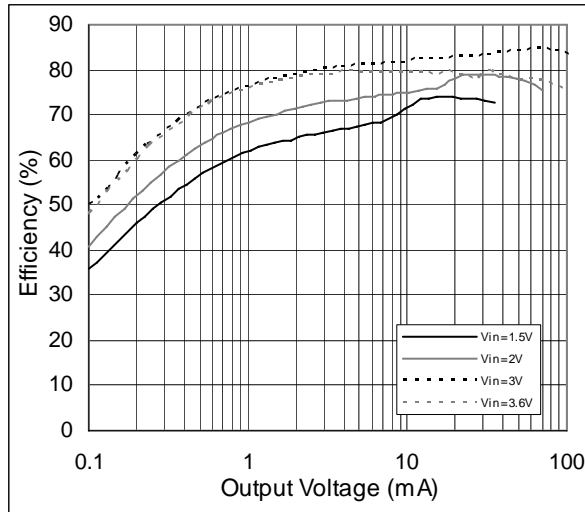

Figure 4. Efficiency vs. Output Current; V<sub>OUT</sub> = 12V

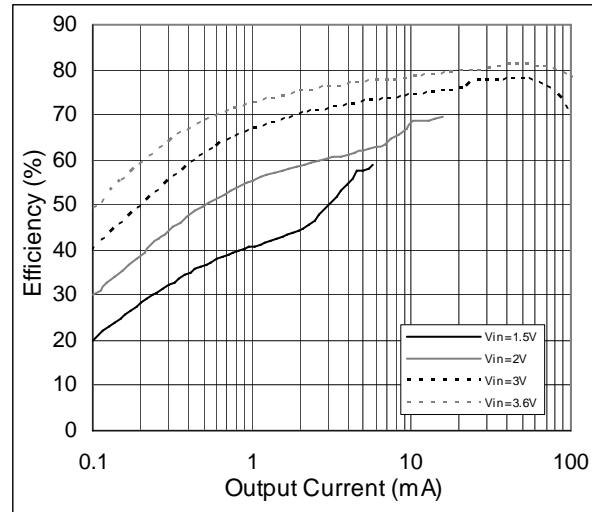

Figure 5. Efficiency vs. Output Current; V<sub>OUT</sub> = 18V

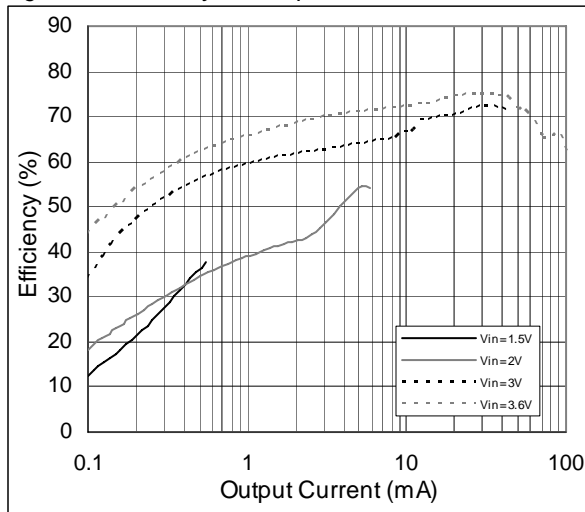

Figure 6. Efficiency vs. Output Current; V<sub>OUT</sub> = 24V

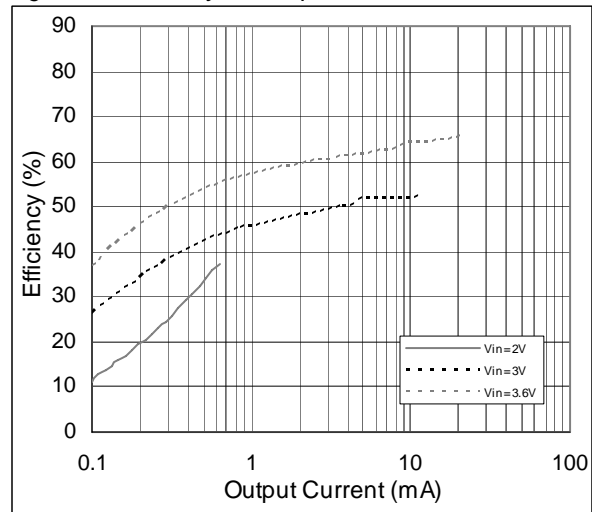

Figure 7. Efficiency vs. Input Voltage; V<sub>OUT</sub> = 12V

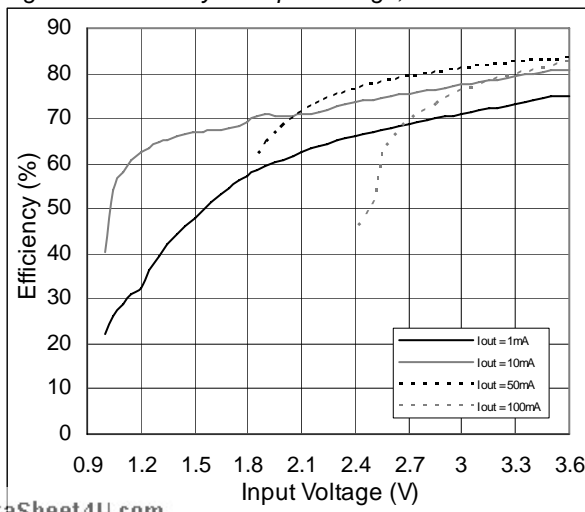

Figure 8. Efficiency vs. Input Voltage; I<sub>OUT</sub> = 10mA

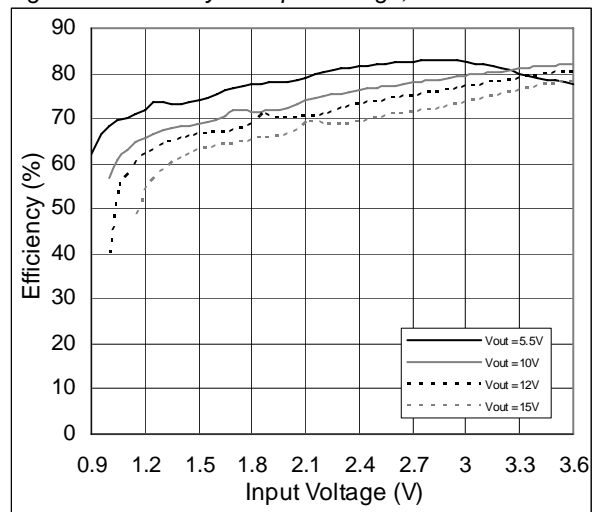

Figure 9. Output Voltage vs. Temperature;  $V_{OUT}=18V$

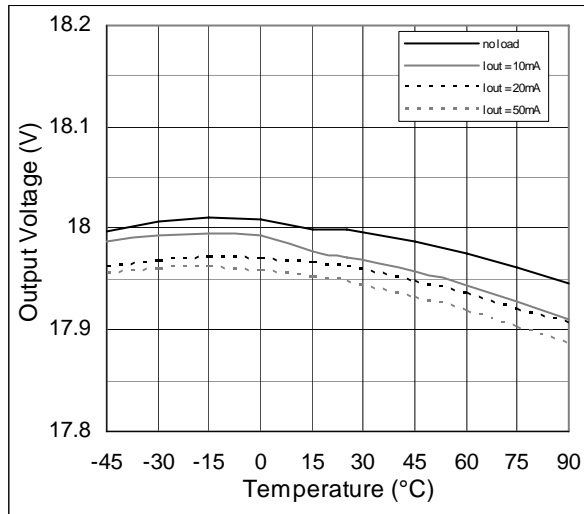

Figure 10. Output voltage vs. Input Voltage;  $V_{OUT}=12V$ , (line regulation)

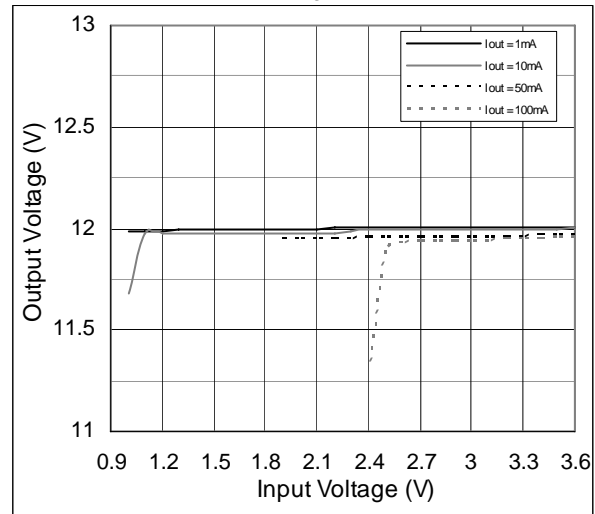

Figure 11. Output Voltage vs. Load Current;  $V_{OUT}=12V$ ,  $V_{IN}=1.5V$ , (load regulation)

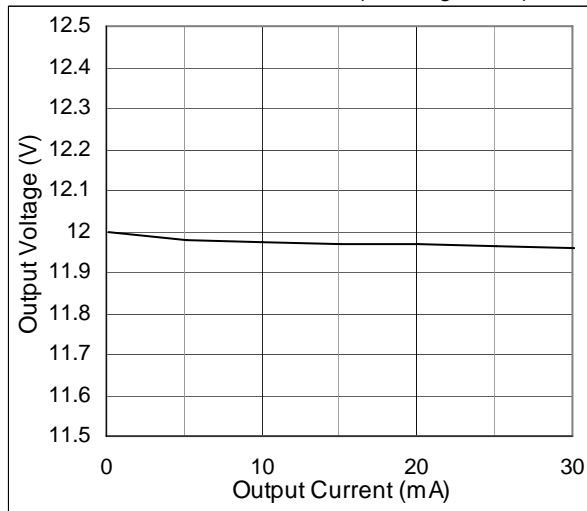

Figure 12. Maximum Output current vs. Input Voltage;  $V_{OUT} = 12, 15, 18, 24, 36V$

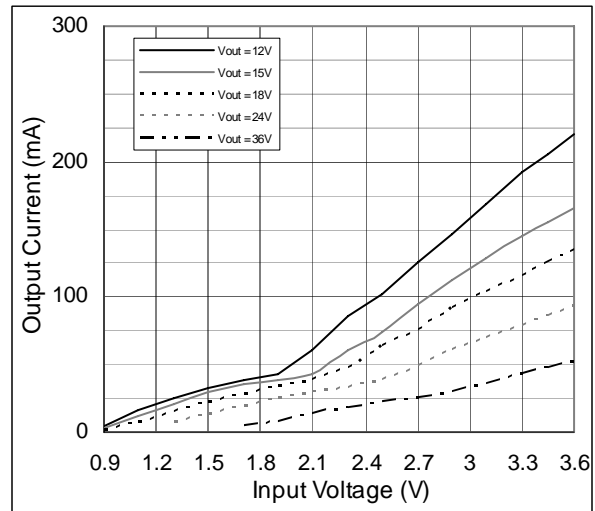

Figure 13. Maximum Output current vs.  $V_{OUT}$ ;  $V_{CC} = 1.5V, 3V$

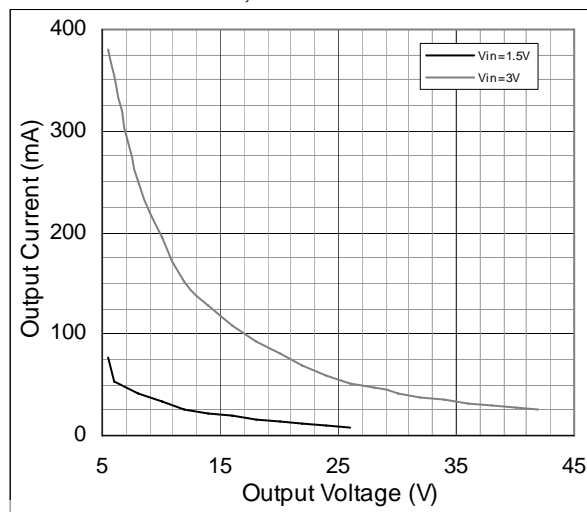

Figure 14. Start-Up Voltage vs. Output Current;  $V_{CC} = 0.5V$  to  $3.6V$ , (95%  $V_{outnom}$ )

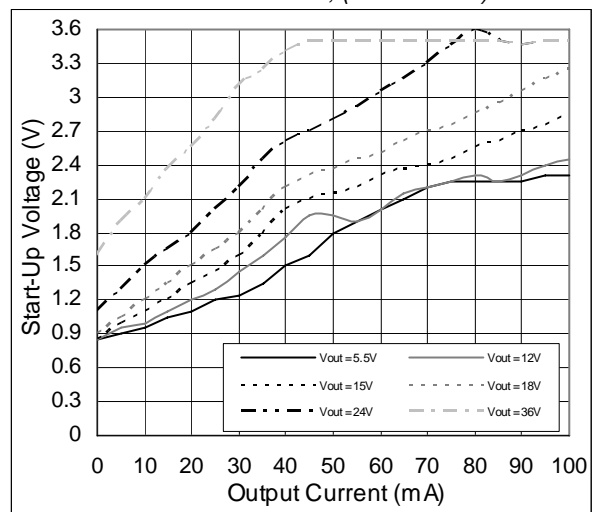

Figure 15. Shutdown Current vs. Vcc

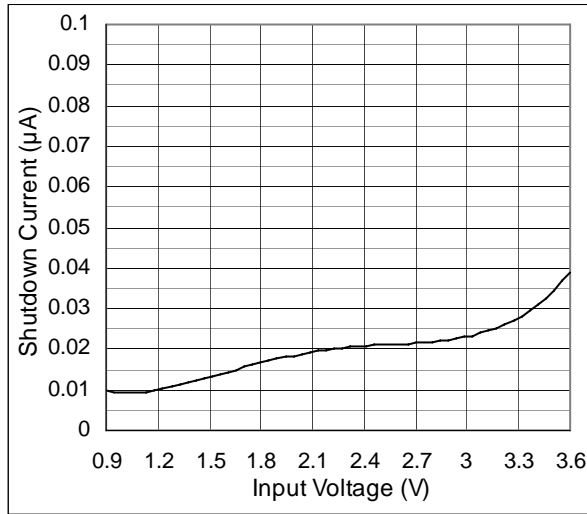

Figure 16. Shutdown Current vs. Temperature

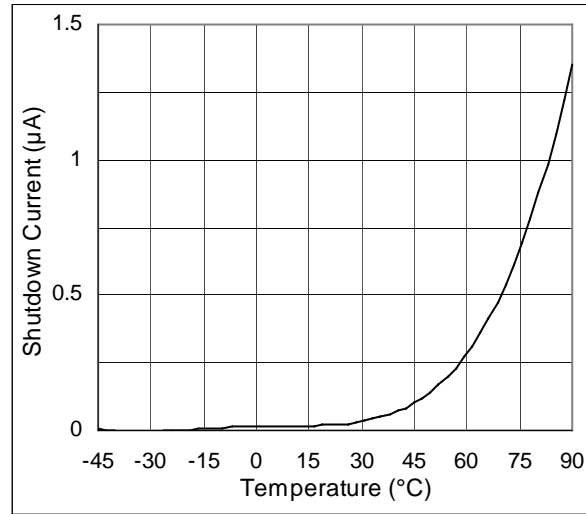

Figure 17. Switching Frequency vs. Temperature

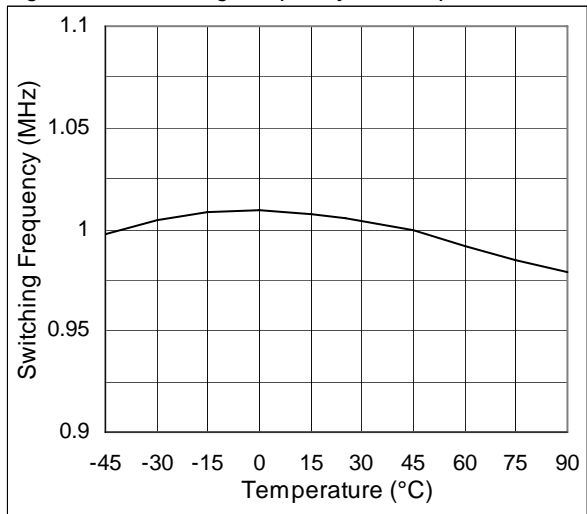

Figure 18. Feedback Voltage vs. Temperature

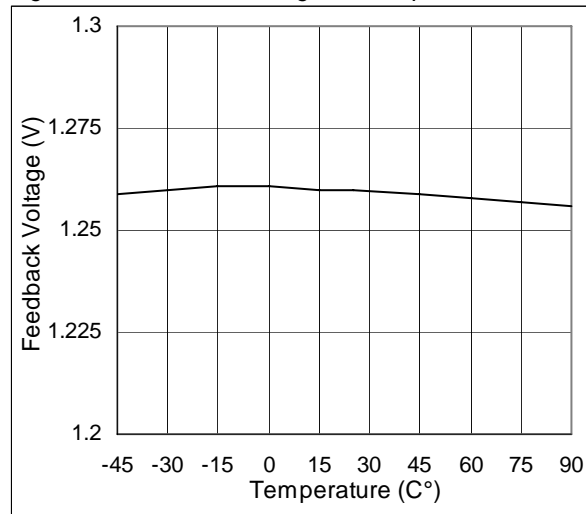

Figure 19. Quiescent Current vs. Vcc

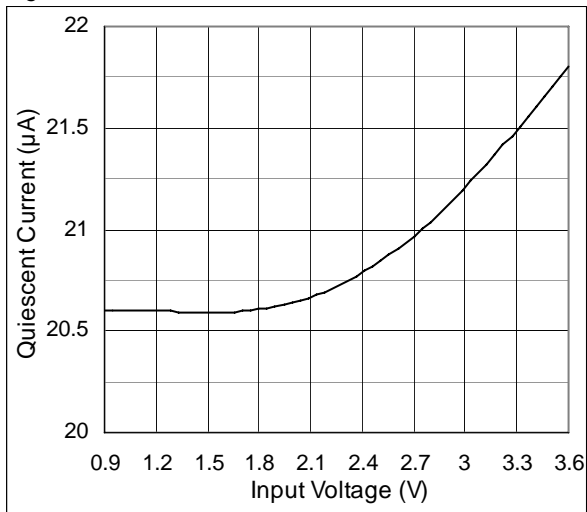

Figure 20. Startup Waveform; VIN = 3.6V

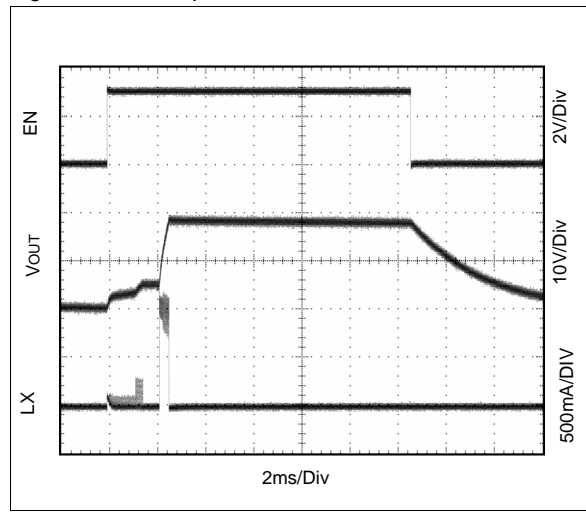

Figure 21. Transient Line Regulation;  
 $V_{OUT} = 18V$ ,  $I_{LOAD} = 1mA$

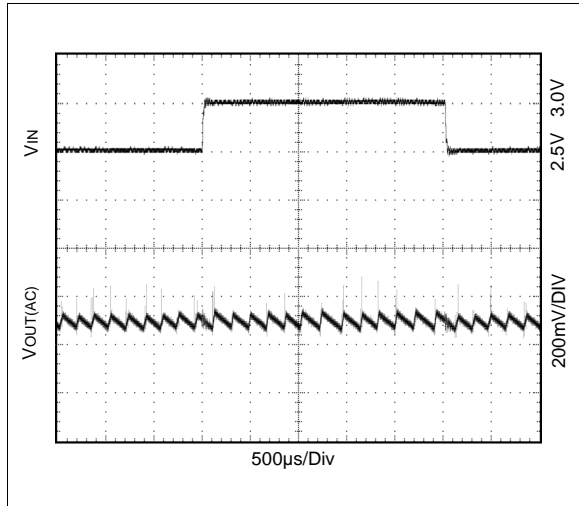

Figure 22. Transient Line Regulation;  
 $V_{OUT} = 18V$ ,  $I_{LOAD} = 20mA$

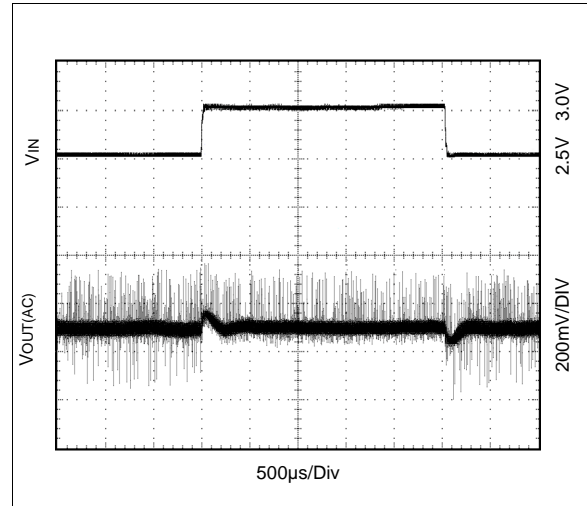

Figure 23. Output Voltage Ripple;  
 $V_{OUT} = 18V$ ,  $I_{OUT} = 1mA$

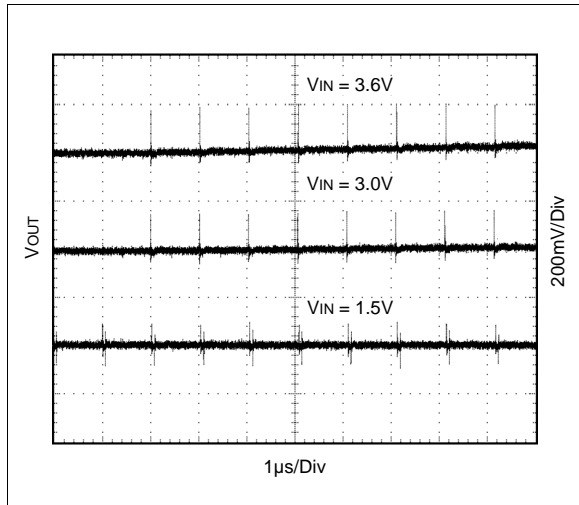

Figure 24. Output Voltage Ripple;  
 $V_{OUT} = 18V$ ,  $I_{OUT} = 20mA$

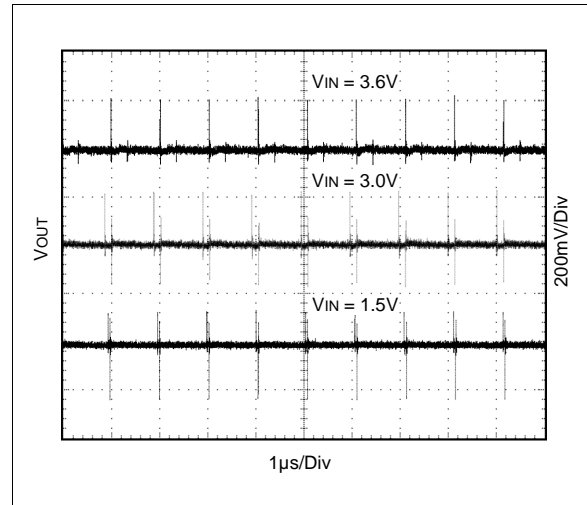

Figure 25. Load Transient Response ON;  
 $V_{CC} = 3V$ ,  $V_{OUT} = 18V$

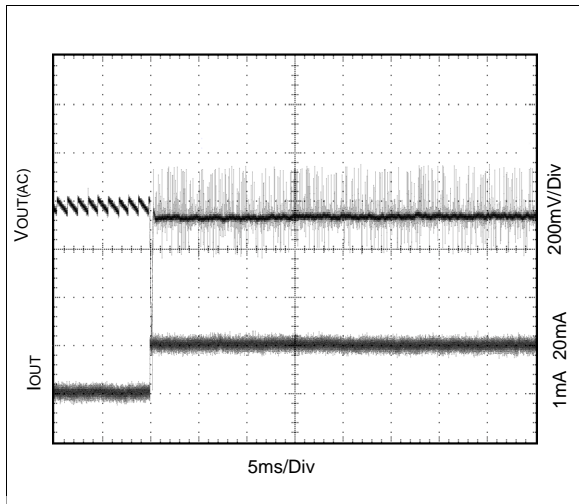
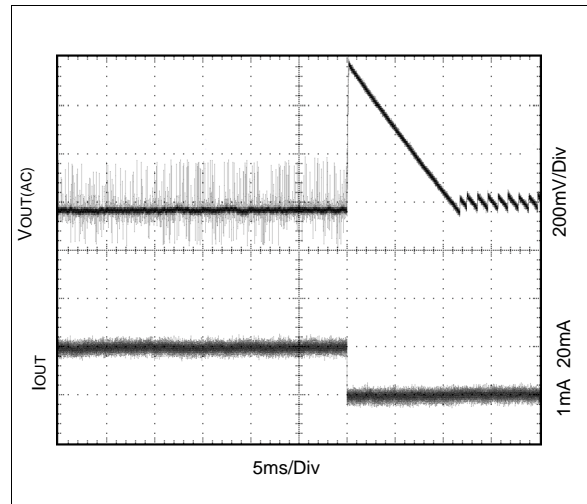

Figure 26. Load Transient Response OFF;  
 $V_{CC} = 3V$ ,  $V_{OUT} = 18V$





## 8 Detailed Description

The AS1343 features a current limiting circuitry, a fixed-frequency PWM architecture, power-OK circuitry, thermal protection, and an automatic powersave mode in a tiny package, and maintains high efficiency at light loads.

Figure 27. AS1343 - Block Diagram with Shutdown Disconnect Switch

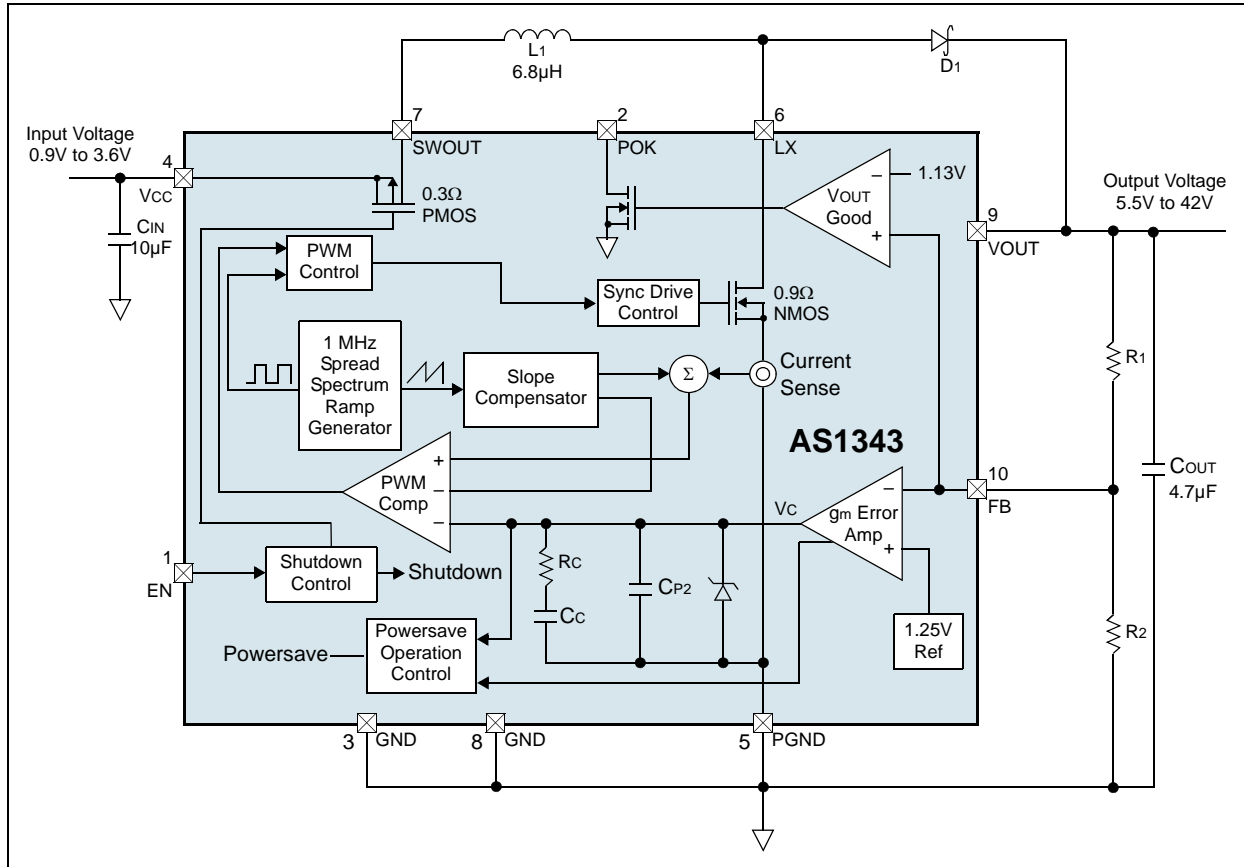

Automatic powersave mode regulates the output and also reduces average current flow into the device, resulting in high efficiency at light loads. When the output increases sufficiently, the powersave comparator output remains high, resulting in continuous operation.

For each oscillator cycle, the power switch is enabled. A voltage proportional to switch current is added to a stabilizing ramp and the resulting sum is delivered to the positive terminal of the PWM comparator.

The error amplifier compares the voltage at FB with the internal 1.25V reference and generates an error signal (Vc). When Vc is below the powersave mode threshold voltage the automatic powersave-mode is activated and the hysteretic comparator disables the power circuitry, with only the low-power circuitry still active (total current consumption is minimized).

When a load is applied, VFB decreases; Vc increases and enables the power circuitry and the device starts switching. In light loads, the output voltage (and the voltage at FB) will increase until the powersave comparator disables the power circuitry, causing the output voltage to decrease again. This cycle is repeated resulting in low-frequency ripple at the output.

### POK Function

The POK output indicates if the output voltage is within 90% of the nominal voltage level. As long as the output voltage is within regulation the open-drain POK output is high impedance. The POK output can be tied to any external voltage up to a maximum of 5V via a pull-up resistance R3 (see Typical Application on page 10). If the output voltage drops below 90% of the nominal voltage the POK pin is pulled to GND.

**Note:** It is important to consider that in shutdown mode the POK output is pulled to Vcc in order to save current.

## 9 Application Information

### Shutdown and Output Discharge

A logic low on the EN pin shuts down the AS1343 and a logic high on the EN pin powers on the device. In shutdown mode the supply current drops to below 3µA and the POK pin is set to high impedance to maximize battery life.

When the battery disconnect switch is used, the battery is disconnected from the output and the output is discharged down to 0V. The time for fully discharging the output depends on the C<sub>OUT</sub> and on the load.

**Note:** Pin EN should not be left floating. If the shutdown feature is not used, connect EN to V<sub>CC</sub>. The output will be discharged during shutdown but the output also must be fully discharged before the device is enabled again.

### Battery Disconnect

The AS1343 has an integrated PMOS switch that can be used to disconnect the battery during shutdown. The operation voltage of this switch is limited to 3.6V. When EN is high, the switch is closed and supplies the inductor. Due to the R<sub>ON</sub> resistance the efficiency is slightly lower if the battery disconnect switch is used.

$$P_{LOSS} = I_{IN}^2 \times R_{ON} \quad (EQ 1)$$

### Setting Output Voltage

Output voltage can be adjusted by connecting a voltage divider between pins V<sub>OUT</sub> and FB (see Figure 28).

Figure 28. Typical Application

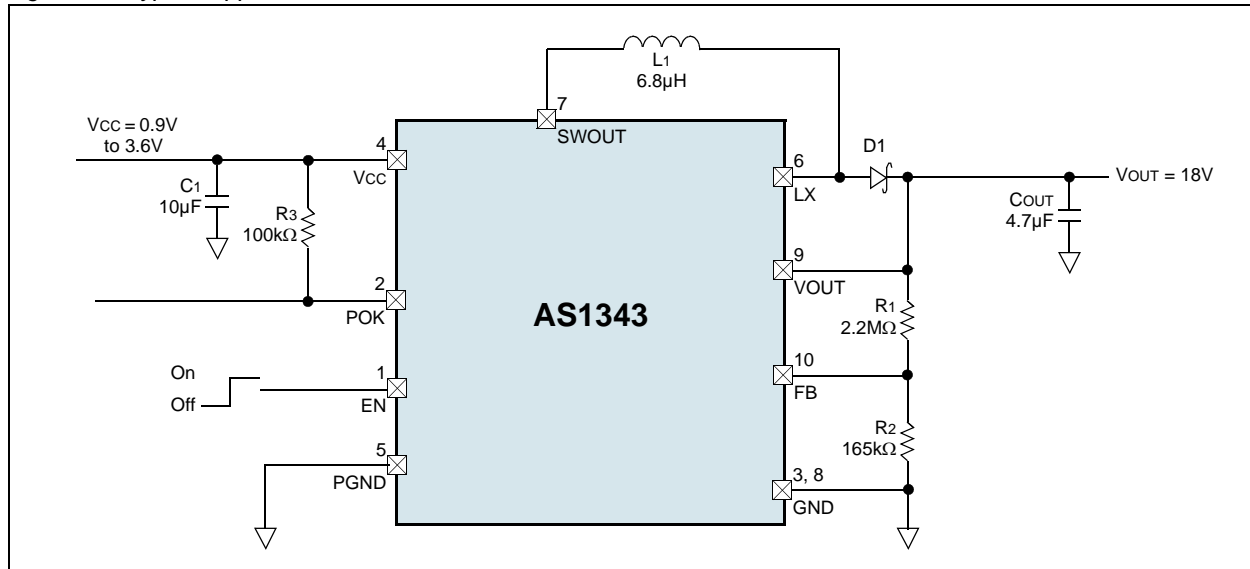

The output voltage can be adjusted by selecting different values for R<sub>1</sub> and R<sub>2</sub>. For R<sub>2</sub>, select a value between 10k and 200kΩ.

Calculate R<sub>1</sub> by:

$$R_1 = R_2 \cdot \left( \frac{V_{OUT}}{V_{FB}} - 1 \right) \quad (EQ 2)$$

**Where:**

V<sub>OUT</sub> = 5.5V to 42V, V<sub>FB</sub> = 1.25V; V<sub>OUT</sub> > V<sub>IN</sub>

The input bias current of FB has a maximum value of 100nA which allows for large-value resistors. For less than 1% error, the current through R<sub>2</sub> should be 100 times the feedback input bias current (I<sub>FB</sub>). That's why the feedback current can be neglected in the calculation of V<sub>OUT</sub>.

**Note:** For the optimal operation condition the following ratio between V<sub>OUT</sub> and V<sub>IN</sub> should be used:

$$V_{OUT} \div V_{IN} \leq 12 \quad (EQ 3)$$

## LED Power Supply Application

The AS1343 can also be used for driving LEDs. Just simply connect the LEDs between the pins VOUT and FB. (see Figure 29).

Figure 29. LED Supply Application

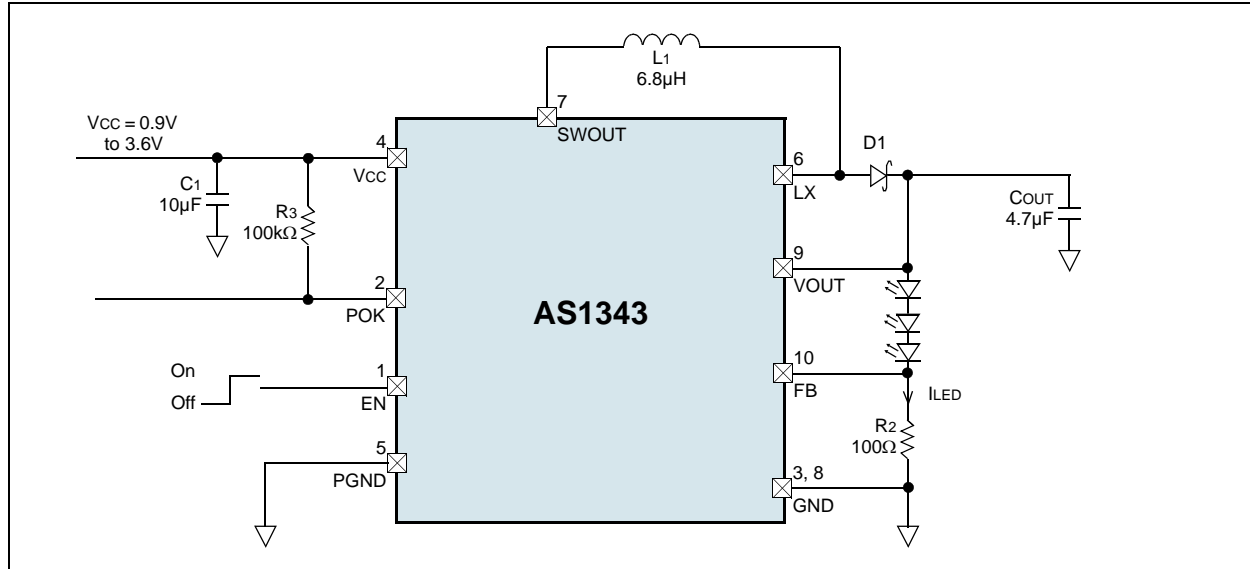

The output voltage is adjusted automatically to the required voltage of the LEDs. This voltage depends on the forward voltage ( $V_F$ ) of the used LEDs and the Feedback Voltage  $V_{FB}$ .

Calculate  $V_{OUT}$  by:

$$V_{OUT} = V_F(I_{LED}) \times n + V_{FB} \quad (EQ 4)$$

**Note:** The brightness of the LEDs can directly be adjusted by setting the current  $I_{LED}$  via the corresponding  $R_2$ .

Calculate  $R_2$  by:

$$I_{LED} = \frac{V_{FB}}{R_2} \quad (EQ 5)$$

**Where:**

$V_{FB} = 1.25V$

$n$  .... number of LEDs

## Thermal Protection

To protect the device from short circuit or excessive power dissipation of the auxiliary NPNs, the integrated thermal protection switches off the device when the junction temperature ( $T_J$ ) reaches  $140^\circ C$  (typ). When  $T_J$  decreases to approximately  $135^\circ C$ , the device will resume normal operation. If the thermal overload condition is not corrected, the device will switch on and off while maintaining  $T_J$  within the range between  $135$  and  $140^\circ C$ .

## Inductor Selection

For the external inductor, a 4.7 $\mu$ H or 6.8 $\mu$ H inductor will usually suffice. Minimum inductor size is dependant on the desired efficiency and output current. Inductors with low core losses and small DCR at 1MHz are recommended. It's also recommendet to choose an inductor which can handle at least 1.2A without saturating. The MOS6020 is a very good choice because the DCR is quite small and the saturation current exceeds 1.2A. For space limiting applications and input currents below 650mA the EPL2014 can be selected. Efficiency losses due to higher DCR should be considered. (see [Figure 30](#) and [Figure 31](#))

Table 4. Recommended Inductors

Part Number	L	DCR	I <sub>SAT</sub> @ 20% drop	Dimensions (L/W/T)	Manufacturer
EPL2014-472MLC	4.7 $\mu$ H	0.231 $\Omega$	0.65A	2.2x2.0x1.4mm	Coilcraft <a href="http://www.coilcraft.com">www.coilcraft.com</a>
LPS3015-472MLC	4.7 $\mu$ H	0.200 $\Omega$	1.2A	3.1x3.1x1.5mm	
LPS4018-682MLC	6.8 $\mu$ H	0.150 $\Omega$	1.3A	4.1x4.1x1.8mm	
LPS5030-682ML_	6.8 $\mu$ H	0.099 $\Omega$	1.7A	4.88x4.88x3.0mm	
MOS6020-682MLC	6.8 $\mu$ H	0.078 $\Omega$	1.56A	6.0x6.8x2.4mm	
MOS6020-472MLC	4.7 $\mu$ H	0.050 $\Omega$	1.82A	6.0x6.8x2.4mm	

**Note:** For the Efficiency measurements in [Figure 30](#) and [Figure 31](#) a MBR0540 diode was used for D<sub>1</sub>.

Figure 30. Efficiency Comparison of different Inductors; V<sub>IN</sub> = 3V, V<sub>OUT</sub> = 18V

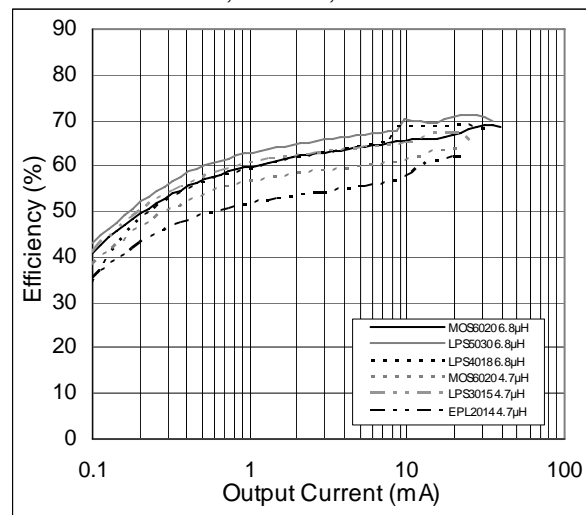
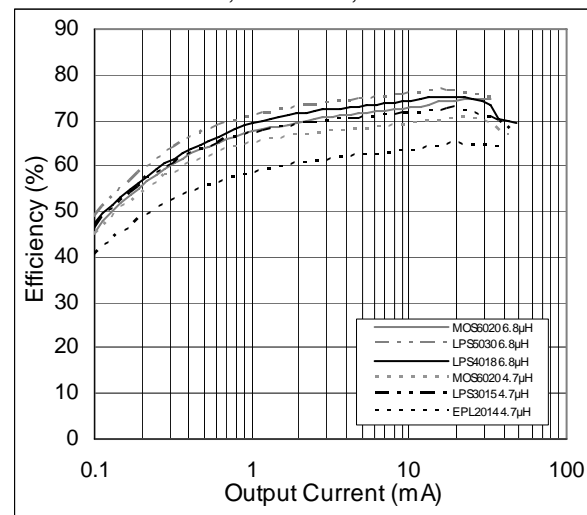

Figure 31. Efficiency Comparison of different Inductors; V<sub>IN</sub> = 3.6V, V<sub>OUT</sub> = 18V



## Capacitor Selection

A 10 $\mu$ F capacitor is recommended for C<sub>IN</sub> as well as a 4.7 $\mu$ F for C<sub>OUT</sub>. Small-sized ceramic capacitors are recommended. X5R and X7R ceramic capacitors are recommended as they retain capacitance over wide ranges of voltages and temperatures.

### Output Capacitor Selection

Low ESR capacitors should be used to minimize V<sub>OUT</sub> ripple. Multi-layer ceramic capacitors are recommended since they have extremely low ESR and are available in small footprints. A 4.7 to 10 $\mu$ F output capacitor is sufficient for most applications. Larger values up to 22 $\mu$ F may be used to obtain extremely low output voltage ripple and improve transient response. The rated voltage of the capacitor should not be lower than the output voltage.

Table 5. Recommended Output Capacitors

Part Number	C	TC Code	Rated Voltage	Dimensions (L/W/T)	Manufacturer
GRM32DR71H335KA88B	3.3 $\mu$ F	X7R	50V	1210	Murata <a href="http://www.murata.com">www.murata.com</a>
GRM32ER71H475KA88	4.7 $\mu$ F	X7R	50V	1210	
GRM31CR61E106KA12	10 $\mu$ F	X5R	25V	1206	
C3225X5R1H335K	3.3 $\mu$ F	X5R	50V	1210	TDK <a href="http://www.tdk.com">www.tdk.com</a>
C3216X5R1E475K	4.7 $\mu$ F	X5R	25V	1206	
C3225X5R1E106K	10 $\mu$ F	X5R	25V	1210	

### Input Capacitor Selection

Low ESR input capacitors reduce input switching noise and reduce the peak current drawn from the battery. Ceramic capacitors are recommended for input decoupling and should be located as close to the device as is practical. A 10 $\mu$ F input capacitor is sufficient for most applications. Larger values may be used for a better stabilization of the supply voltage.

Table 6. Recommended Input Capacitors

Part Number	C	TC Code	Rated Voltage	Dimensions (L/W/T)	Manufacturer
GRM21BR60J106KE19	10 $\mu$ F	X5R	6.3V	0805	Murata <a href="http://www.murata.com">www.murata.com</a>
GRM188R60J106ME47	10 $\mu$ F	X5R	6.3V	0603	
GRM21BR60J226ME39	22 $\mu$ F	X5R	6.3V	0805	
C1608X5R0J106MB	10 $\mu$ F	X5R	6.3V	0603	TDK <a href="http://www.tdk.com">www.tdk.com</a>
C2012X5R0J226M	22 $\mu$ F	X5R	6.3V	0805	

## Diode Selection

A Schottky diode must be used to carry the output current into the Cout and load during the NMOS switch-off time.

**Note:** Do not use ordinary rectifier diodes, since the slow recovery times will compromise efficiency.

The MBR0520 is a good choice because of the very low forward voltage and the extremely fast switching. If the output voltage exceeds 20V the use of the PMEG4005 or the MBR0540 (40V Schottky diodes) is recommended. These diodes are designed to handle an average forward current of 500mA. In applications with higher loads, the PMEG4010 or the MBRM140 should be used, due to the rated average forward current of 1A.

Table 7. Recommended Diodes

Part Number	Reverse Voltage	Forward Current	Package	Manufacturer
MBR0540	40V	0.5A	SOD123	MCC <a href="http://www.mccsemi.com">www.mccsemi.com</a>
MBR0520	20V	0.5A	SOD123	
PMEG4005	40V	0.5A	SOD123	Philips <a href="http://www.nxp.com">www.nxp.com</a>
PMEG4010	40V	1A	SOD123	
MBRM140	40V	1A	SOD123	ON Semiconductor <a href="http://www.onsemi.com">www.onsemi.com</a>

Figure 32. Efficiency Comparison of different Diodes;  
 $V_{IN} = 3V$ ,  $V_{OUT} = 18V$ ,  $L_1 = 6.8\mu H$

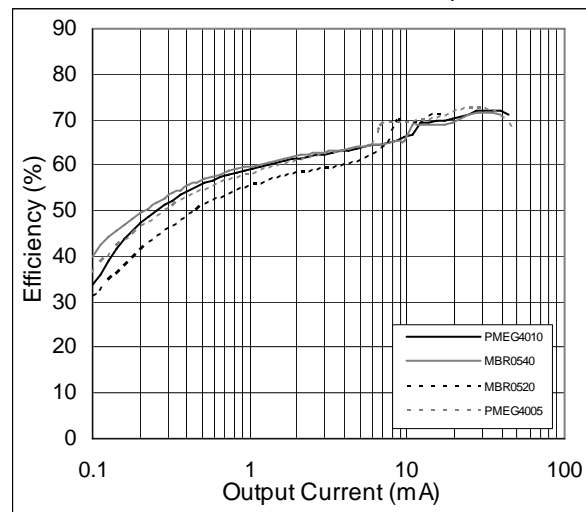
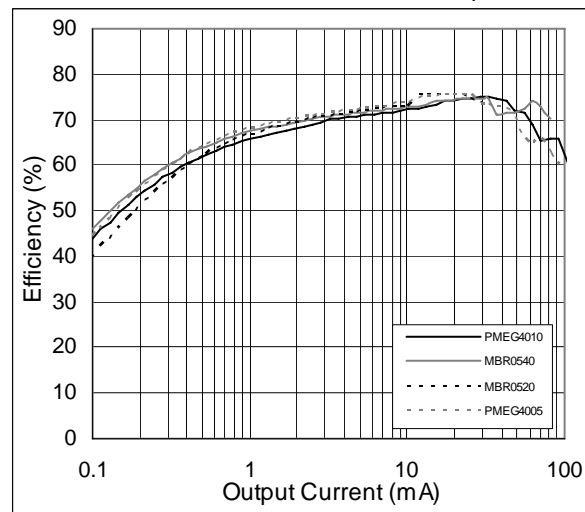

Figure 33. Efficiency Comparison of different Diodes;  
 $V_{IN} = 3.6V$ ,  $V_{OUT} = 18V$ ,  $L_1 = 6.8\mu H$



## 10 Package Drawings and Markings

The devices are available in a TDFN-10 3x3mm package.

Figure 34. TDFN-10 3x3mm Package

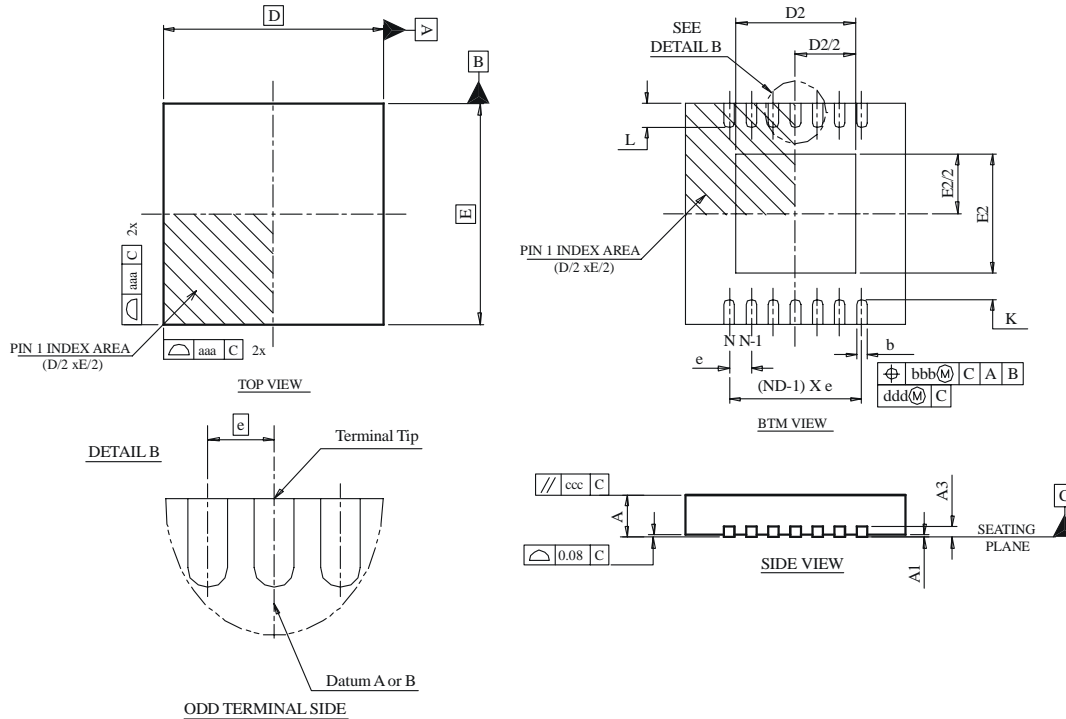

Symbol	Min	Typ	Max	Notes
A	0.70	0.75	0.80	1, 2
A1	0.00	0.02	0.05	1, 2
A3		0.20 REF		1, 2
L1	0.03		0.15	1, 2
L2			0.13	1, 2
aaa		0.15		1, 2
bbb		0.10		1, 2
ccc		0.10		1, 2
ddd		0.05		1, 2
eee		0.08		1, 2
ggg		0.10		1, 2

Symbol	Min	Typ	Max	Notes
D BSC		3.00		1, 2
E BSC		3.00		1, 2
D2	1.60		2.50	1, 2
E2	1.35		1.75	1, 2
L	0.30	0.40	0.50	1, 2
$\theta$	0°		14°	1, 2
K	0.20			1, 2
b	0.18	0.25	0.30	1, 2, 5
e		0.50		
N		10		1, 2
ND		5		1, 2, 5

### Notes:

- Figure 34 is shown for illustration only.
- All dimensions are in millimeters; angles in degrees.
- Dimensioning and tolerancing conform to ASME Y14.5 M-1994.
- N is the total number of terminals.
- The terminal #1 identifier and terminal numbering convention shall conform to JEDEC 95-1, SPP-012. Details of terminal #1 identifier are optional, but must be located within the zone indicated. The terminal #1 identifier may be either a mold or marked feature.
- Dimension b applies to metallized terminal and is measured between 0.15mm and 0.30mm from the terminal tip.
- ND refers to the maximum number of terminals on side D.
- Unilateral coplanarity zone applies to the exposed heat sink slug as well as the terminals

## 11 Ordering Information

The device is available as the standard products shown in [Table 8](#).

Table 8. Ordering Information

Model	Marking	Description	Delivery Form	Package
AS1343A-BTDT-10	ASQN	42V, Micropower, DC-DC Boost Converter, Automatic Power Save, 1MHz	Tape and Reel	TDFN-10 3x3mm

**Note:** All products are RoHS compliant and Pb-free.

Buy our products or get free samples online at ICdirect: <http://www.austriamicrosystems.com/ICdirect>

For further information and requests, please contact us <mailto:sales@austriamicrosystems.com> or find your local distributor at <http://www.austriamicrosystems.com/distributor>



## Copyrights

Copyright © 1997-2009, austriamicrosystems AG, Tobelbaderstrasse 30, 8141 Unterpremstaetten, Austria-Europe. Trademarks Registered ®. All rights reserved. The material herein may not be reproduced, adapted, merged, translated, stored, or used without the prior written consent of the copyright owner.

All products and companies mentioned are trademarks or registered trademarks of their respective companies.

## Disclaimer

Devices sold by austriamicrosystems AG are covered by the warranty and patent indemnification provisions appearing in its Term of Sale. austriamicrosystems AG makes no warranty, express, statutory, implied, or by description regarding the information set forth herein or regarding the freedom of the described devices from patent infringement. austriamicrosystems AG reserves the right to change specifications and prices at any time and without notice. Therefore, prior to designing this product into a system, it is necessary to check with austriamicrosystems AG for current information. This product is intended for use in normal commercial applications. Applications requiring extended temperature range, unusual environmental requirements, or high reliability applications, such as military, medical life-support or life-sustaining equipment are specifically not recommended without additional processing by austriamicrosystems AG for each application. For shipments of less than 100 parts the manufacturing flow might show deviations from the standard production flow, such as test flow or test location.

The information furnished here by austriamicrosystems AG is believed to be correct and accurate. However, austriamicrosystems AG shall not be liable to recipient or any third party for any damages, including but not limited to personal injury, property damage, loss of profits, loss of use, interruption of business or indirect, special, incidental or consequential damages, of any kind, in connection with or arising out of the furnishing, performance or use of the technical data herein. No obligation or liability to recipient or any third party shall arise or flow out of austriamicrosystems AG rendering of technical or other services.



## Contact Information

### Headquarters

austriamicrosystems AG  
Tobelbaderstrasse 30  
A-8141 Unterpremstaetten, Austria

Tel: +43 (0) 3136 500 0  
Fax: +43 (0) 3136 525 01

For Sales Offices, Distributors and Representatives, please visit:

<http://www.austriamicrosystems.com/contact>