

2SC4512

Silicon NPN Triple Diffused Planar Transistor (Complement to type 2SA1726)

Application : Audio and General Purpose

Absolute maximum ratings (Ta=25°C)

Symbol	Ratings	Unit
Vcbo	120	V
Vceo	80	V
Vebo	6	V
Ic	6	A
Ib	3	A
Pc	50(Tc=25°C)	W
Tj	150	°C
Tstg	-55 to +150	°C

Electrical Characteristics (Ta=25°C)

Symbol	Conditions	Ratings	Unit
Icbo	Vcb=120V	10max	μA
IEBO	VEB=6V	10max	μA
V(BR)CEO	Ic=25mA	80min	V
hFE	VCE=4V, Ic=2A	50min	
VCE(sat)	Ic=5A, Ib=0.2A	0.5max	V
fr	VCE=12V, IE=-0.5A	20typ	MHz
COB	Vcb=10V, f=1MHz	110typ	pF

*hFE Rank \bar{O} (50to100), P(70to140), Y(90to180)

External Dimensions MT-25(TO220)

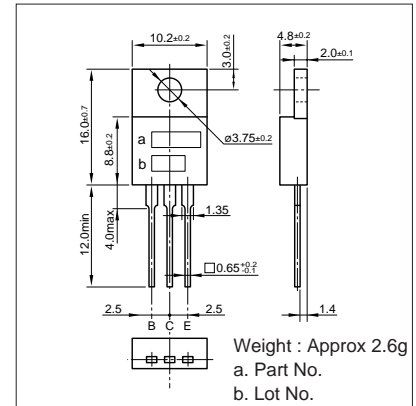

Typical Switching Characteristics (Common Emitter)

Vcc (V)	RL (Ω)	Ic (A)	VBB1 (V)	VBB2 (V)	IB1 (A)	IB2 (A)	ton (μs)	tstg (μs)	tf (μs)
30	10	3	10	-5	0.3	-0.3	0.16typ	2.60typ	0.34typ

Ic-VCE Characteristics (Typical)

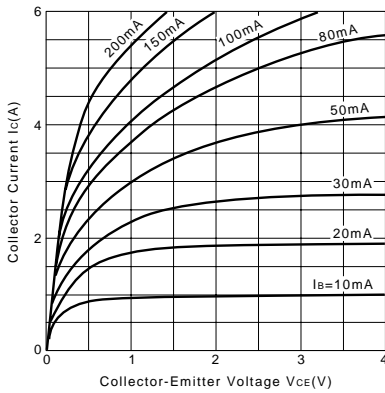

VCE(sat)-Ib Characteristics (Typical)

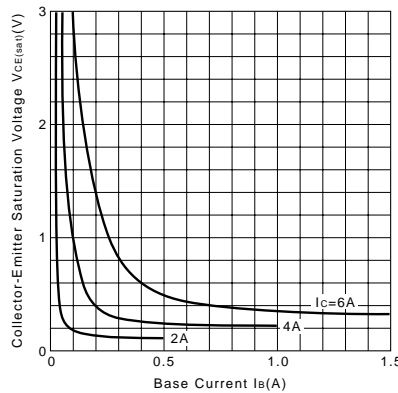

Ic-VBE Temperature Characteristics (Typical)

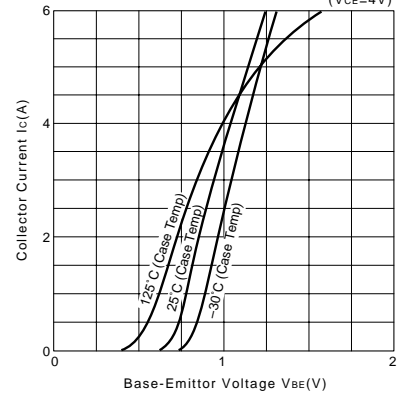

hFE-Ic Characteristics (Typical)

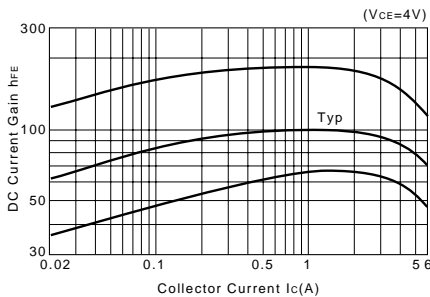

hFE-Ic Temperature Characteristics (Typical)

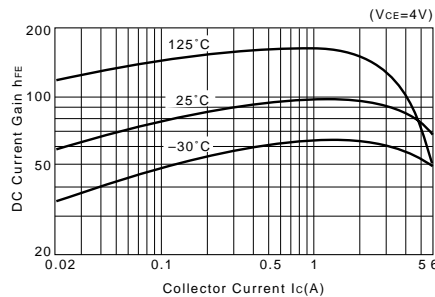

θj-a-t Characteristics

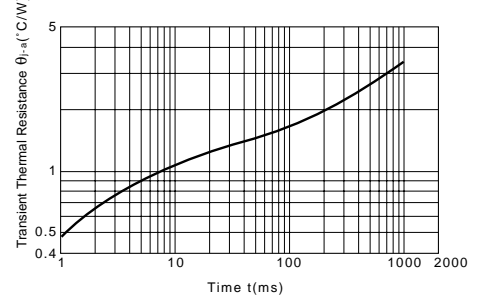

fr-IE Characteristics (Typical)

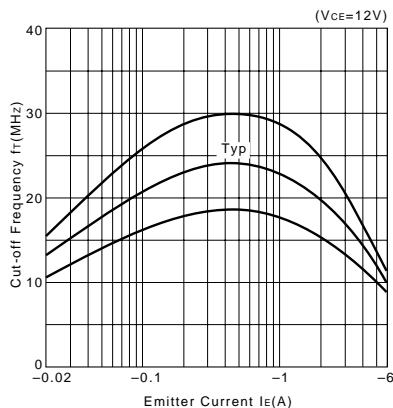

Safe Operating Area (Single Pulse)

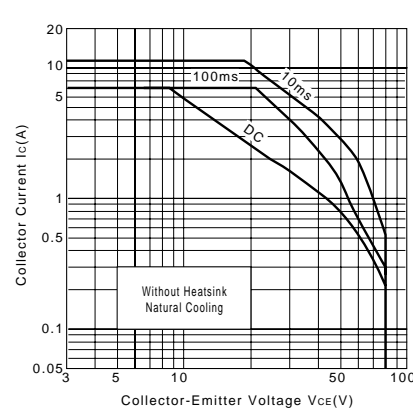

Pc-Ta Derating

