



P-Channel Enhancement-Mode Vertical DMOS Power FETs

T-39-19

Ordering Information

| BV _{DSS} / BV _{DGS} | R _{DS(ON)} (max) | I _{D(ON)} (min) | Order Number / Package | | | | |
|---------------------------------------|---------------------------|--------------------------|------------------------|----------|----------|------------|------------|
| | | | TO-39 | TO-92 | TO-220 | Quad P-DIP | Quad C-DIP |
| -40V | 4Ω | 1.5A | VP0204N2 | — | VP0204N5 | VP0204N6 | VP0204N7 |
| -60V | 4Ω | 1.5A | VP0206N2 | VP0206N3 | VP0206N5 | VP0206N6 | VP0206N7 |
| -100V | 4Ω | 1.5A | VP0210N2 | VP0210N3 | VP0210N5 | — | — |

Features

- Freedom from secondary breakdown
- Low power drive requirement
- Ease of paralleling
- Low C_{ISS} and fast switching speeds
- Excellent thermal stability
- Integral Source-Drain diode
- High input impedance and high gain
- Complementary N- and P-Channel devices

Advanced DMOS Technology

These enhancement-mode (normally-off) power transistors utilize a vertical DMOS structure and Supertex's well-proven silicon-gate manufacturing process. This combination produces devices with the power handling capabilities of bipolar transistors and with the high input impedance and negative temperature coefficient inherent in MOS devices. Characteristic of all MOS structures, these devices are free from thermal runaway and thermally-induced secondary breakdown.

Supertex Vertical DMOS Power FETs are ideally suited to a wide range of switching and amplifying applications where high breakdown voltage, high input impedance, low input capacitance, and fast switching speeds are desired.

Applications

- Motor control
- Convertors
- Amplifiers
- Switches
- Power supply circuits
- Driver (Relays, Hammers, Solenoids, Lamps, Memories, Displays, Bipolar Transistors, etc.)

Package Options

(Notes 1 and 2)

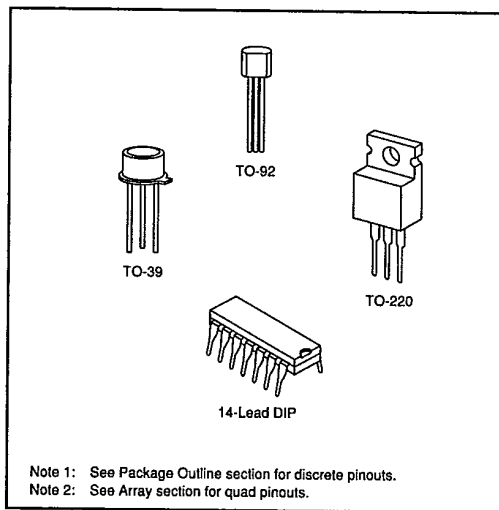

Note 1: See Package Outline section for discrete pinouts.
 Note 2: See Array section for quad pinouts.

Absolute Maximum Ratings

| | |
|-----------------------------------|-------------------|
| Drain-to-Source Voltage | BV _{DSS} |
| Drain-to-Gate Voltage | BV _{DGS} |
| Gate-to-Source Voltage | ± 20V |
| Operating and Storage Temperature | -55°C to +150°C |
| Soldering Temperature* | 300°C |

*Distance of 1.6 mm from case for 10 seconds.

Thermal Characteristics

| Package | I _D (continuous)* | I _D (pulsed)* | Power Dissipation @ T _C = 25°C | θ _{JC} °C/W | θ _{JA} °C/W | I _{DR} | I _{DRM} * |
|-------------|--|--------------------------|---|----------------------|----------------------|-----------------|--------------------|
| TO-39 | -0.8A | -4.0A | 6W | 125 | 20 | -0.8A | -4.0A |
| TO-92 | -0.4A | -3.5A | 1W | 170 | 125 | -0.4A | -3.5A |
| TO-220 | -2.0A | -4.5A | 27W | 70 | 4.7 | -2.0A | -4.5A |
| Plastic Dip | Refer to Arrays & Special Functions Section. | | | | | | |
| Ceramic Dip | | | | | | | |

* I_D (continuous) is limited by max rated T_J.

Electrical Characteristics (@ 25°C unless otherwise specified)

(Notes 1 and 2)

| Symbol | Parameter | Min | Typ | Max | Unit | Conditions |
|----------------------|--|--------|------|------|-------|---|
| BV _{DSS} | Drain-to-Source Breakdown Voltage | VP0210 | -100 | | | I _D = -2.5mA, V _{GS} = 0 |
| | | VP0206 | -60 | | | |
| | | VP0204 | -40 | | | |
| V _{GS(th)} | Gate Threshold Voltage | -1.0 | | -3.5 | V | V _{GS} = V _{DS} , I _D = -2.5mA |
| ΔV _{GS(th)} | Change in V _{GS(th)} with Temperature | | -3.0 | -3.5 | mV/°C | I _D = -2.5mA, V _{GS} = V _{DS} |
| I _{GSS} | Gate Body Leakage | | -1.0 | -100 | nA | V _{GS} = ±20V, V _{DS} = 0 |
| I _{DSS} | Zero Gate Voltage Drain Current | | | -25 | μA | V _{GS} = 0, V _{DS} = Max Rating |
| | | | -0.6 | -1.0 | mA | V _{GS} = 0, V _{DS} = 0.8 Max Rating T _A = 125°C |
| I _{D(ON)} | ON-State Drain Current | -0.4 | | | A | V _{GS} = -5V, V _{DS} = -25V |
| | | -1.5 | -2.5 | | | V _{GS} = -10V, V _{DS} = -25V |
| R _{DS(ON)} | Static Drain-to-Source ON-State Resistance | | 3.5 | 8.0 | Ω | V _{GS} = -5V, I _D = -0.25A |
| | | | 3 | 4.0 | | V _{GS} = -10V, I _D = 500mA |
| ΔR _{DS(ON)} | Change in R _{DS(ON)} with Temperature | | 0.75 | 1.2 | %/°C | I _D = -1.0A, V _{GS} = -10V |
| G _{FS} | Forward Transconductance | 0.3 | 0.5 | | ∅ | V _{DS} = -25V, I _D = -1.0A |
| C _{ISS} | Input Capacitance | | 90 | 150 | pF | V _{GS} = 0, V _{DS} = -25V f = 1 MHz |
| C _{OSS} | Common Source Output Capacitance | | 65 | 85 | | |
| C _{RSS} | Reverse Transfer Capacitance | | 15 | 20 | | |
| t _{d(ON)} | Turn-ON Delay Time | | 5 | 10 | ns | V _{DD} = -25V I _D = -1A R _S = 50Ω |
| t _r | Rise Time | | 7 | 10 | | |
| t _{d(OFF)} | Turn-OFF Delay Time | | 10 | 15 | | |
| t _f | Fall Time | | 6 | 10 | | |
| V _{SD} | Diode Forward Voltage Drop | -1.3 | -2.0 | | | |
| t _{rr} | Reverse Recovery Time | | 430 | | ns | I _{SD} = -1A, V _{GS} = 0 |

Note 1: All D.C. parameters 100% tested at 25°C unless otherwise stated (Pulse test: 300μs pulse, 2% duty cycle.)

Note 2: All A.C. parameters sample tested.

Switching Waveforms and Test Circuit

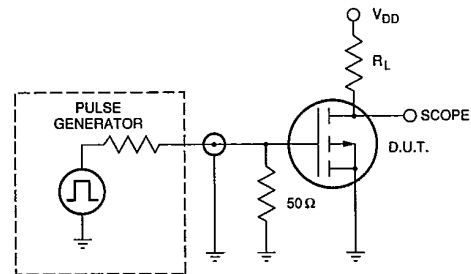
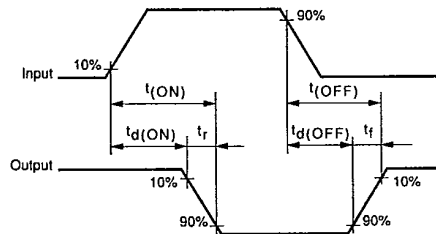

Typical Performance Curves

T-39-19

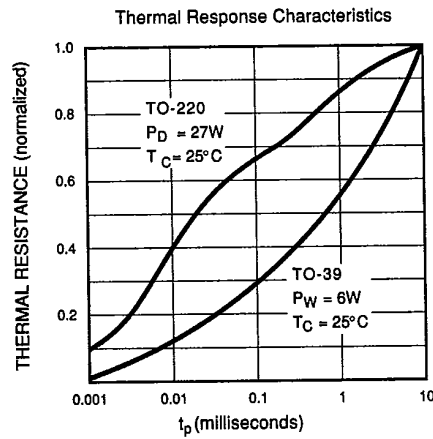
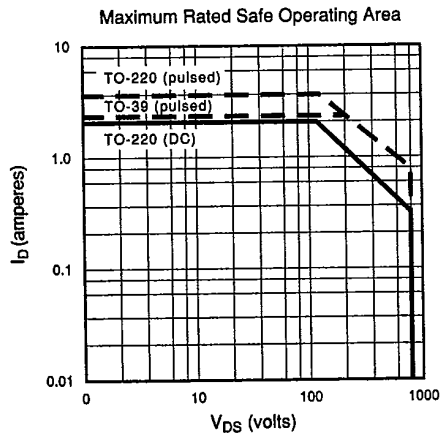
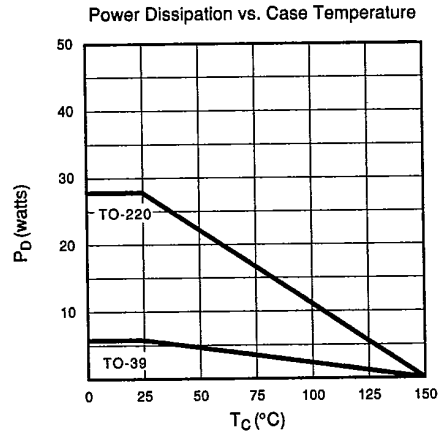
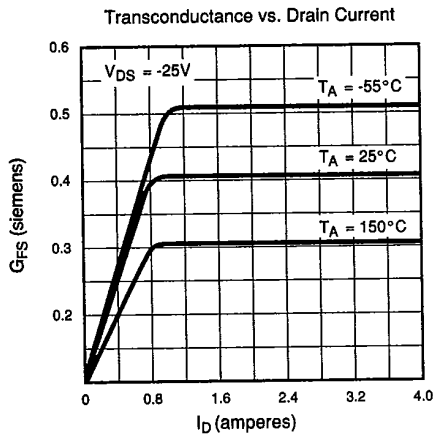
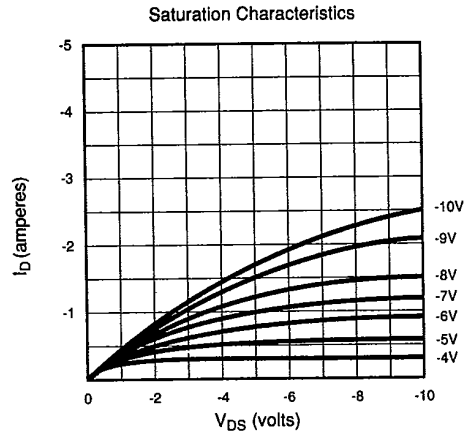
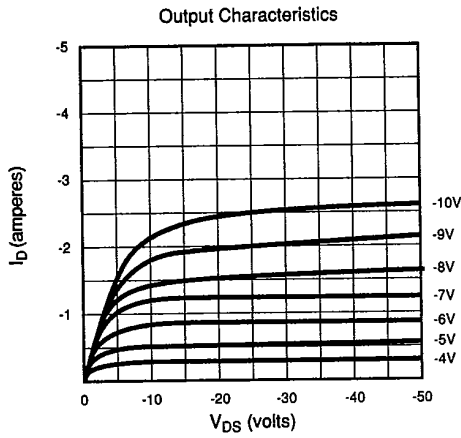

9

T-39-19

