

**IGBT MODULE ( Single-in-Line )**

**■ Features**

- Square RBSOA
- Low Saturation Voltage
- Improved FWD Characteristic
- Minimized Internal Stray Inductance

**■ Applications**

- High Power Switching
- A.C. Motor Controls
- D.C. Motor Controls

**■ Outline Drawing**

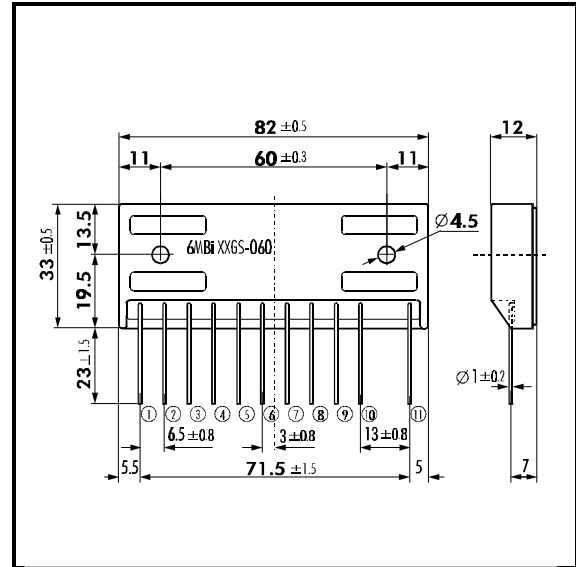

**■ Maximum Ratings and Characteristics**

**• Absolute Maximum Ratings ( T<sub>c</sub>=25°C )**

Items	Symbols	Ratings	Units
Collector-Emitter Voltage	V <sub>CES</sub>	600	V
Gate -Emitter Voltage	V <sub>GES</sub>	± 20	V
Collector Current	Continuous	I <sub>C</sub>	20
	1ms	I <sub>C PULSE</sub>	40
	Continuous	-I <sub>C</sub>	20
	1ms	-I <sub>C PULSE</sub>	40
Max. Power Dissipation	P <sub>C</sub>	70	W
Operating Temperature	T <sub>j</sub>	+150	°C
Storage Temperature	T <sub>stg</sub>	-40 ~ +125	°C
Isolation Voltage	V <sub>is</sub>	2000	V
Screw Torque	Mounting *1	1.7	Nm

Note: \*1.Recommendable Value; 1.3 ~ 1.7 Nm (M4)

**■ Equivalent Circuit**

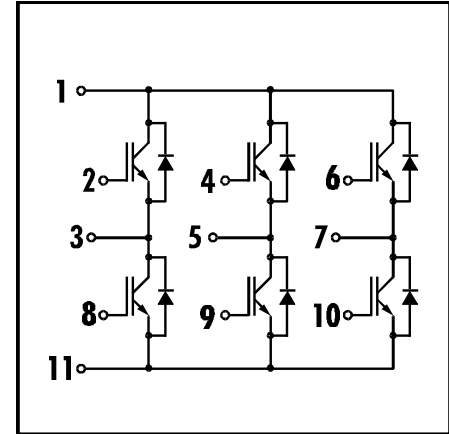

**• Electrical Characteristics ( at T<sub>j</sub>=25°C )**

Items	Symbols	Test Conditions	Min.	Typ.	Max.	Units
Zero Gate Voltage Collector Current	I <sub>CES</sub>	V <sub>GE</sub> =0V V <sub>CE</sub> =600V			1.0	mA
Gate-Emitter Leakage Current	I <sub>GES</sub>	V <sub>CE</sub> =0V V <sub>GE</sub> =± 20V			100	nA
Gate-Emitter Threshold Voltage	V <sub>GE(th)</sub>	V <sub>GE</sub> =20V I <sub>C</sub> =10mA	5.5		8.5	V
Collector-Emitter Saturation Voltage	V <sub>CE(sat)</sub>	V <sub>GE</sub> =15V I <sub>C</sub> =10A			2.8	V
Input capacitance	C <sub>ies</sub>	V <sub>GE</sub> =0V		1300		pF
Output capacitance	C <sub>oes</sub>	V <sub>CE</sub> =10V		300		
Reverse Transfer capacitance	C <sub>res</sub>	f=1MHz		72		
Turn-on Time	t <sub>ON</sub>	V <sub>CC</sub> =300V			1.2	µs
	t <sub>r</sub>	I <sub>C</sub> =20A			1.0	
Turn-off Time	t <sub>OFF</sub>	V <sub>GE</sub> =± 15V			1.0	
	t <sub>f</sub>	R <sub>G</sub> =120Ω			0.35	
Diode Forward On-Voltage	V <sub>F</sub>	I <sub>F</sub> =20A V <sub>GE</sub> =0V			3.0	V
Reverse Recovery Time	t <sub>rr</sub>	I <sub>F</sub> =20A			300	ns

**• Thermal Characteristics**

Items	Symbols	Test Conditions	Min.	Typ.	Max.	Units
Thermal Resistance	R <sub>th(j-c)</sub>	IGBT			1.79	°C/W
	R <sub>th(j-e)</sub>	Diode			2.50	
	R <sub>th(c-t)</sub>	With Thermal Compound		0.06		

Collector-Emitter voltage vs. Collector current  
 $T_j=25^\circ\text{C}$

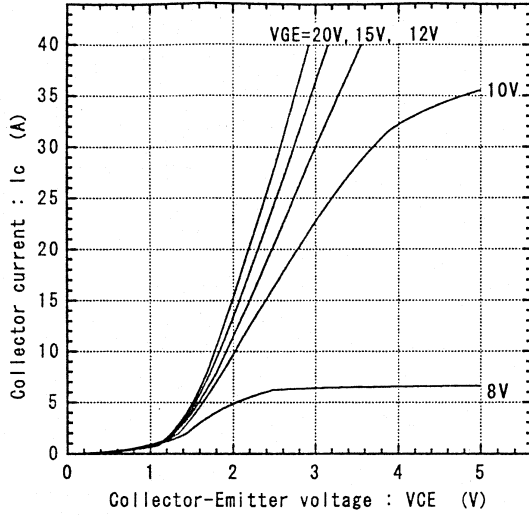

Collector-Emitter voltage vs. Collector current  
 $T_j=125^\circ\text{C}$

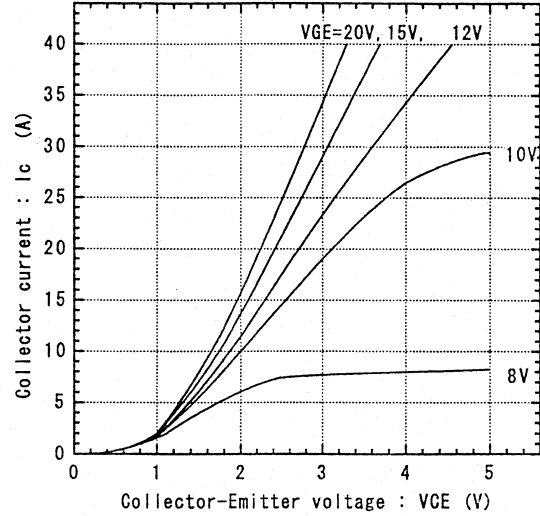

Collector-Emitter vs. Gate-Emitter voltage  
 $T_j=25^\circ\text{C}$

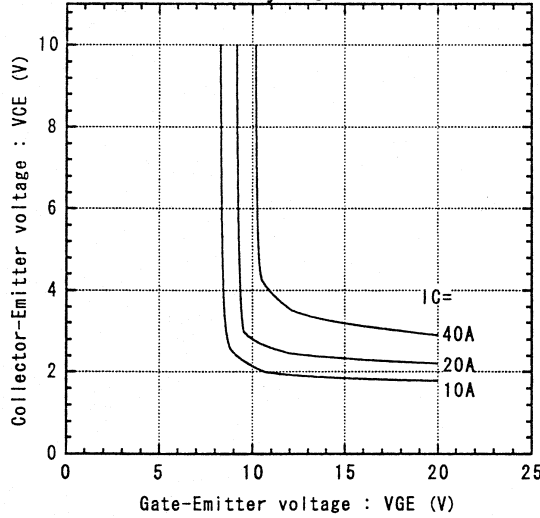

Collector-Emitter vs. Gate-Emitter voltage  
 $T_j=125^\circ\text{C}$

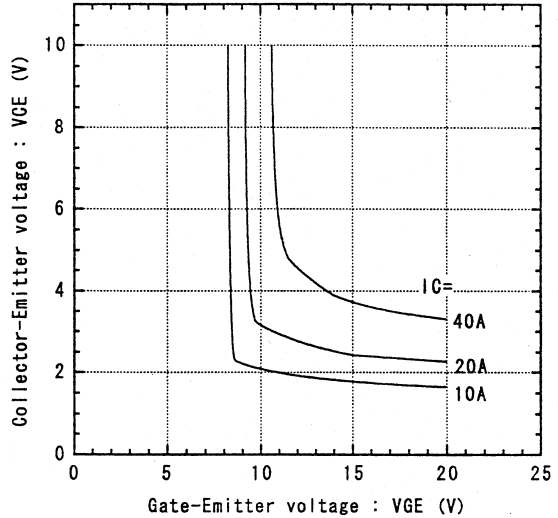

Switching time vs. Collector current  
 $V_{cc}=300\text{V}$ ,  $R_G=120\Omega$ ,  $V_{GE}=\pm 15\text{V}$ ,  $T_j=25^\circ\text{C}$

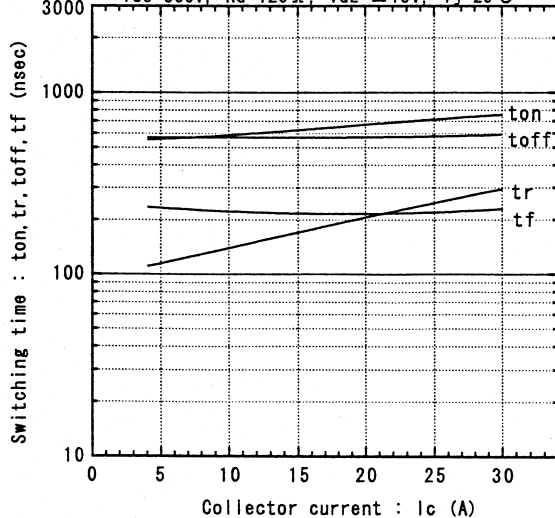

Switching time vs. Collector current  
 $V_{cc}=300\text{V}$ ,  $R_G=120\Omega$ ,  $V_{GE}=\pm 15\text{V}$ ,  $T_j=125^\circ\text{C}$

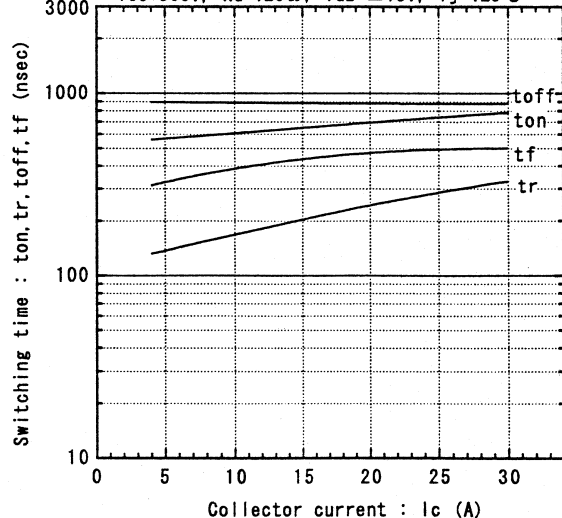

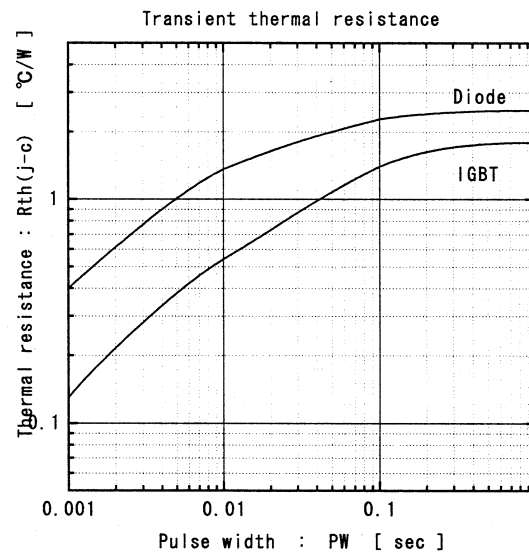
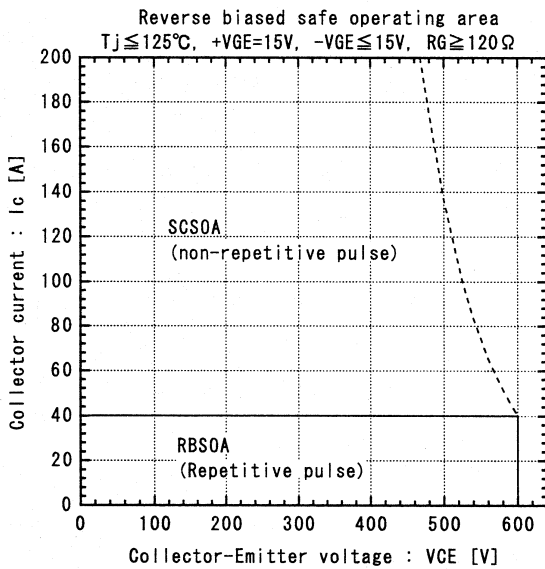
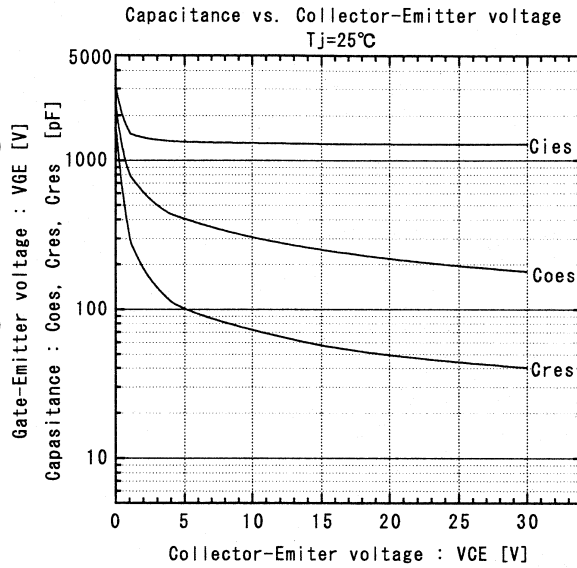
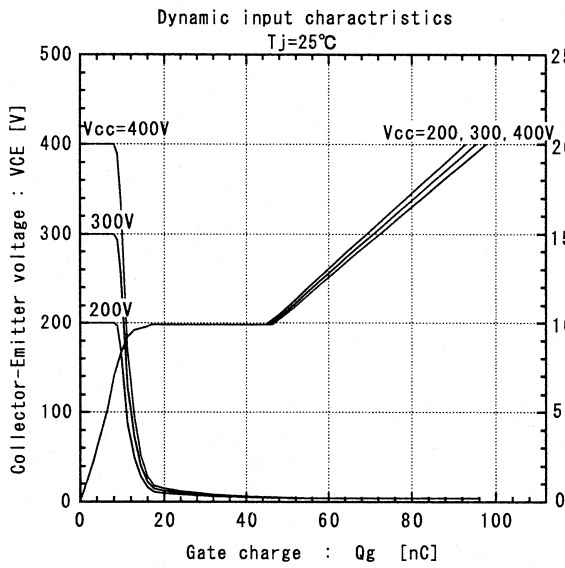
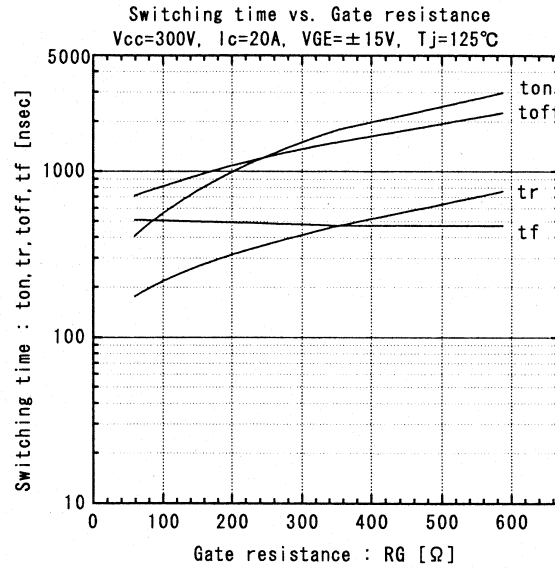
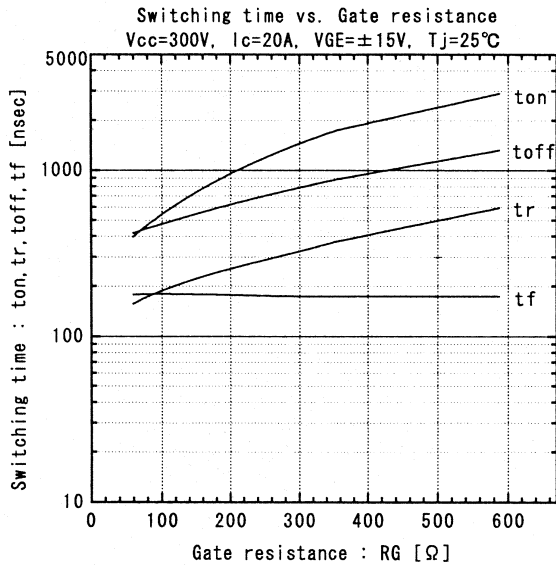

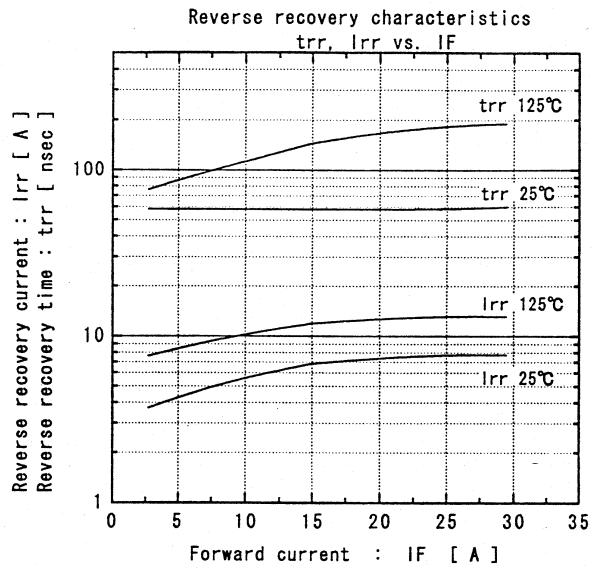
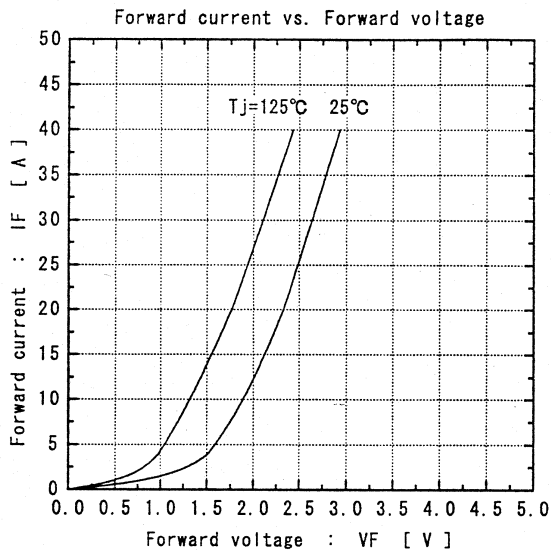
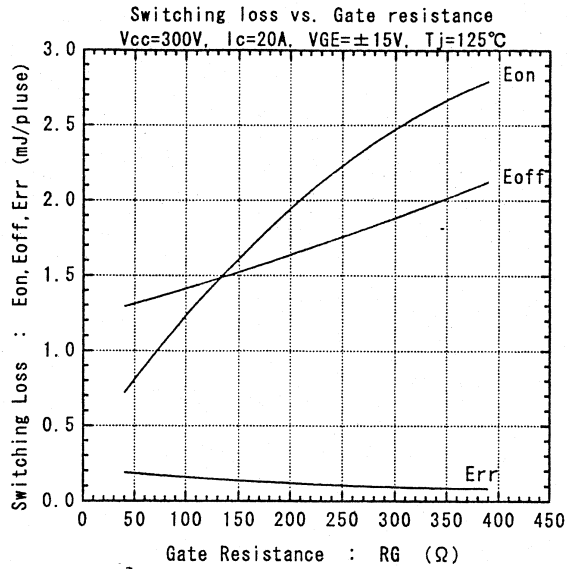
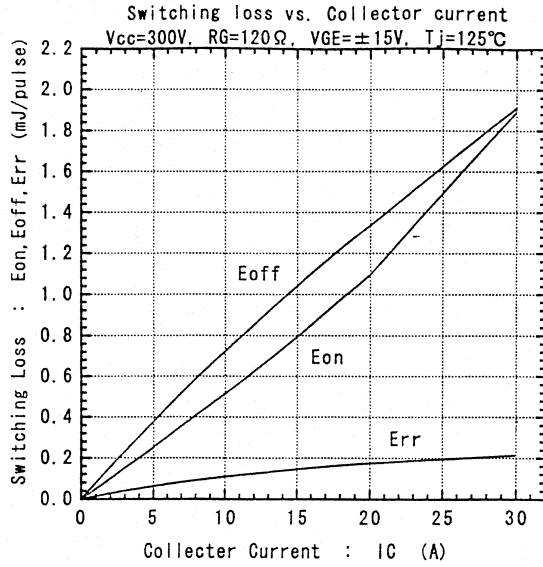

**Fuji Electric GmbH**

Lyoner Straße 26

D-60528 Frankfurt/M

Tel.: 069 - 66 90 29 - 0

Fax.: 069 - 66 90 29 - 56

**Fuji Electric (UK) Ltd.**

Commonwealth House  
2 Chalkhill Road Hammersmith

London W6 8DW, UK

Tel.: 0181 - 233 11 30

Fax.: 0181 - 233 11 60