

description The **ECG724** is a monolithic RF/IF amplifier intended for emitter-coupled (differential) or cascode amplifier operation from DC to 120 MHz in industrial and communications equipment.

features

- Controlled for input offset voltage, input offset current, and input bias current
- Balanced differential amplifier configuration with controlled constant-current source to provide unexcelled versatility
- Single- and dual-ended operation
- Operation from DC to 120 MHz
- Balanced-AGC capability
- Wide operating-current range.

applications

- RF and IF linear amplifiers, both differential and cascode
- Mixers
- Oscillators
- Converters in commercial FM
- DC, audio and sense amplifiers
- Limiting IF amplifiers
- Hybrid building block
- Emitter coupled switches

typical applications

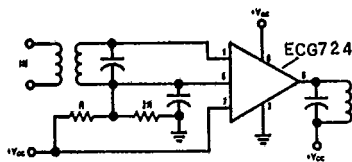

A Balanced Differential Amplifier with a Controlled Constant-Current-Source Drive and AGC Capability

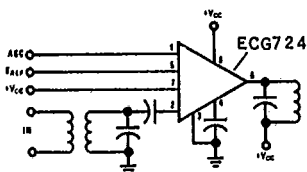

A Cascode Amplifier with a Constant-Impedance AGC Capability

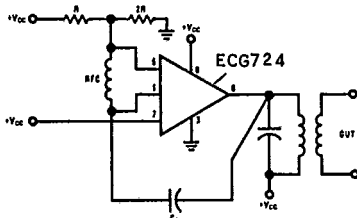
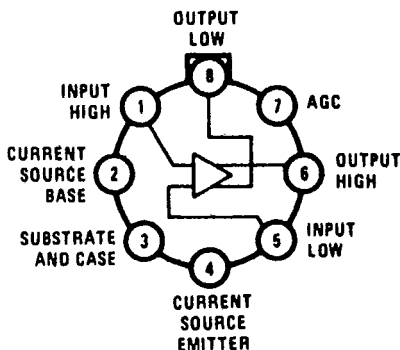
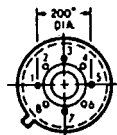
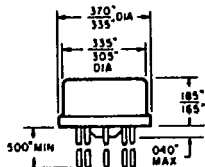

Oscillator

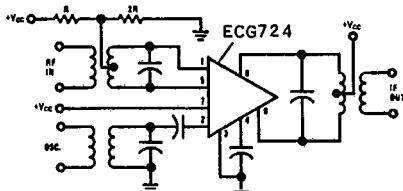

Mixer

dc electrical characteristics

www.DataSheet4U.com		SYMBOL	TEST CIRCUIT	V _{CC}	V _{EE}	MIN	TYP	MAX	UNITS
Input Offset Voltage	V _{OS}	A	A	6	-6		0.4	2.0	mV
				12	-12		0.4	2.0	mV
Input Offset Current	I _{OS}	B	B	6	-6		0.15	2.0	μA
				12	-12		0.25	2.0	μA
Input Bias Current	I _{BIAS}	B	B	6	-6		7.5	40	μA
				12	-12		17	80	μA
Output Quiescent Operating Current	I _Q	B	B	6	-6	1.1	1.25	1.5	mA
				12	-12	2.5	3.15	4.0	mA
AGC Bias Current into Terminal 7	I _{AGC}	D	D	12	V _{AGC} =9V V _{AGC} =12V		1.1		mA
				12		1.5		mA	
				9				mA	
				12				mA	
Input Current into Terminal 7	I ₇	B	B	6	-6	0.5	0.7	1.1	mA
				12	-12	1.0	1.5	2.2	mA
Power Dissipation	P _D	B	B	6	-6	24	35	42	mW
				12	-12	120	170	220	mW

ac electrical characteristics

	SYMBOL	TEST CIRCUIT	V _{CC}	V _{EE}	MIN	TYP	MAX	UNITS
100 MHz Power Gain	A _p	E(Cascode) F(Diff.)	9	-	17	22		dB
			9	-	14.5	18.6		dB
10.7 MHz Power Gain	A _p	E(Cascode) F(Diff.)	9	-	36	42		dB
			9	-	29	33.5		dB
100 MHz Noise Figure	NF	E(Cascode) F(Diff.)	9	-		8.7	9.0	dB
			9	-		5.9	9.0	dB
Input Admittance at 10.7 MHz	Y ₁₁	Cascode Diff.	+9	-		0.5+j1.3		mmho
			+9	-		0.4+j0.58		mmho
Reverse Transmittance at 10.7 MHz	Y ₁₂	Cascode Diff.	+9	-		0.2+j0		μmho
			+9	-		10+j0.2		μmho
Forward Transmittance at 10.7 MHz	Y ₂₁	Cascode Diff.	+9	-		95-j27		mmho
			+9	-		-32+j.5		mmho
Output Admittance at 10.7 MHz	Y ₂₂	Cascode Diff.	+9	-		0+j100		μmho
			+9	-		20+j160		μmho
Output Power (Untuned) at 10.7 MHz	P ₀	G	+9	-		5.7		μW
AGC Range at 10.7 MHz		F	+9	-		76		dB
Voltage Gain at 10.7 MHz	A _v	H(Cascode) I(Diff.)	+9	-		40		dB
			+9	-		30		dB
Differential 1 kHz Voltage Gain	A _{vD}	J	6	-6	35	38	42	dB
			12	-12	40	42.5	45	dB
Maximum Peak to Peak Output Voltage at 1 kHz	V _{OUT, PP} ^{MAX}	J R _L =2k J R _L =1.6k	6	-6	8	11		V _{pp}
			12	-12	16	22		V _{pp}
3 dB Bandwidth	BW	J R _L =2k J R _L =1.6k	6	-6		11.2		MHz
			12	-12		12.7		MHz
Common-Mode Input Voltage Range	V _{CM}	K	6	-6	-2.5	-3.2 to +4.5	4	V
			12	-12	-5	-7 to +9	7	V
Common-Mode Rejection Ratio	CMRR	K	6	-6	60	110		dB
			12	-12	60	90		dB
Peak to Peak Output Current V _{IN} = 400 mV at 10.7 MHz	I _{pp}	Diff. Diff.	9	-	2.5	4.7	6	mA
			12	-	4.5	7.5	8	mA

absolute maximum ratings

Supply Operating Voltage	±15V
Differential Input Voltage	±5V
Voltage Between 1 & 8	0V to +20V
Voltage Between 5 & 6	0V to +20V
Voltage Between 2 & 3	+5V to -11V
Voltage Between 2 & 4	+5V to -1V
Storage Temperature	-65°C to 200°C
Operating Temperature	-55°C to 125°C
Power Dissipation @ 25°C	450 mW
Derate 5 mW/°C Above 85°C	
Lead Temperature (Soldering, 10 sec)	300°C

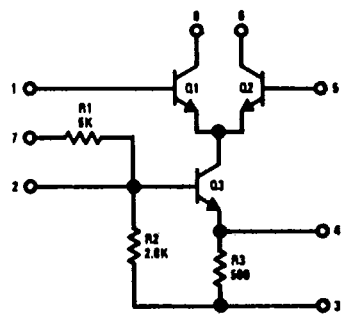

schematic

test circuits

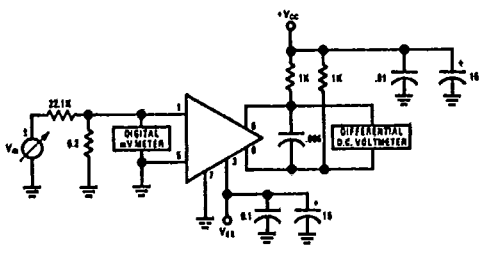

Test Circuit A: VOS

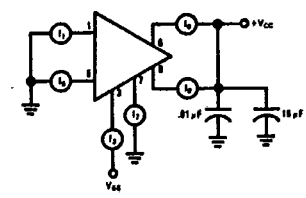

Test Circuit B: IOS, IBIAS, PD, IQ & I7

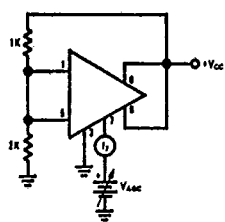

Test Circuit D: IAGC vs VAGC and I7

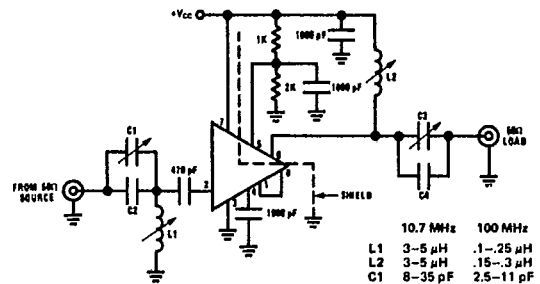

Test Circuit E: Cascode Ap & NF 10.7 MHz & 100 MHz

	10.7 MHz	100 MHz
L1	3-5 μH	.1-.25 μH
L2	3-5 μH	.15-.3 μH
C1	8-35 pF	2.5-11 pF
C2	39 pF	20 pF
C3	8-35 pF	2.5-11 pF
C4	36 pF	-

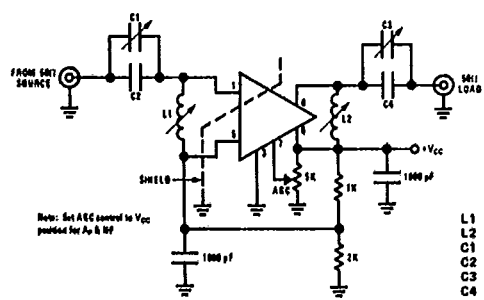

Note: Set AGC control to Vcc position for Ap & NF

	10.7 MHz	100 MHz
L1	3-6 μH	.2-.5 μH
L2	3-6 μH	.2-.5 μH
C1	8-35 pF	2.5-11 pF
C2	39 pF	-
C3	8-35 pF	2.5-11 pF
C4	36 pF	-

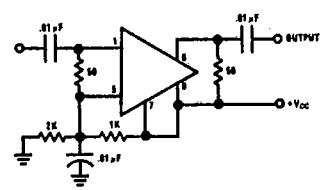

Test Circuit G: Po (continued)

Test Circuit F: Differential Ap, NF and AGC Range, 10.7 MHz & 100 MHz

Test Circuit G: Po (continued)

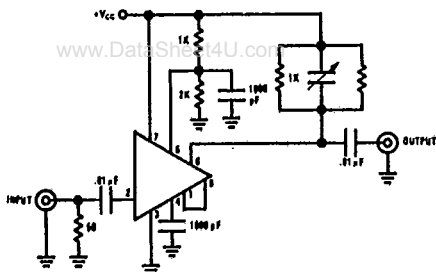

Test Circuit H: Cascode A_V and Transfer Function, 10.7 MHz

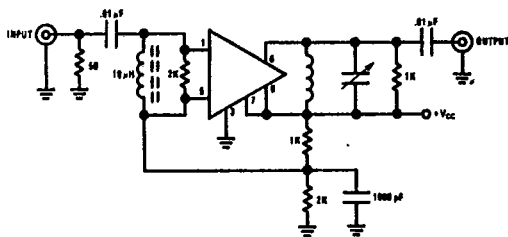

Test Circuit I: Differential Mode A_V and Transfer Function, 10.7 MHz

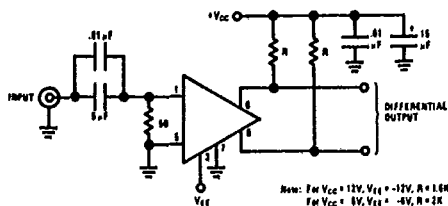

Test Circuit J: A_V , $V_{OUT, MAX}$, p/p B.W.

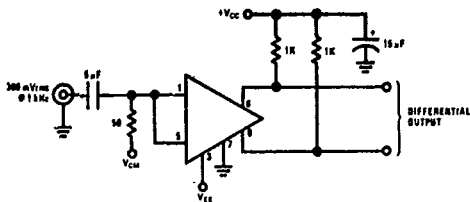

Test Circuit K: CMRR and V_{CM} Range

definition of terms

AGC Bias Current: The current drawn by the device from the AGC-voltage source, at maximum AGC voltage.

AGC Range: The total change in voltage gain (from maximum gain to complete cutoff) which may be achieved by application of the specified range of dc voltage to the AGC input terminal of the device.

Common-Mode Rejection Ratio: The ratio of the full differential voltage gain to the common-mode voltage gain.

Device Dissipation: The total power drain of the device with no signal applied and no external load current.

Input Bias Current: The average value (one-half the sum) of the currents at the two input terminals when the quiescent operating voltages at the two output terminals are equal.

Input Offset Current: The difference in the currents at the two input terminals when the quiescent operating voltages at the two output terminals are equal.

Input Offset Voltage: The difference in the dc voltages which must be applied to the input terminals to obtain equal quiescent operating voltages (zero output offset voltage) at the output terminals.

Noise Figure: The ratio of the total noise power of the device and a resistive signal source to the noise power of the signal source alone, the signal source representing a generator of zero impedance in series with the source resistance.

Power Gain: The ratio of the signal power developed at the output of the device to the signal power applied to the input, expressed in dB.

Quiescent Operating Current: The average (dc) value of the current in either output terminal.

Voltage Gain: The ratio of the change in output voltage at either output terminal with respect to ground, to a change in input voltage at either input terminal with respect to ground, with the other input terminal at 0V.