

SPECIFICATIONS

CUSTOMER : CKR057





SAMPLE CODE (Ver.) : PS12864LRF-018-H01(Ver.C)

MASS PRODUCTION CODE (Ver.) : PE12864LRF-018-H(Ver.B)

DRAWING NO. (Ver.) : PE- 04011-002(Ver.C)

Customer Approved

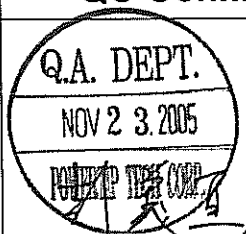
Date:

Approved	QC Confirmed	Designer
 		 

Approval For Specifications Only.

* This specification is subject to change without notice.

Please contact Powertip or it's representative before designing your product based on this specification.

Approval For Specifications and Sample.

POWERTIP TECH. CORP.

Headquarters:

No.8, 6th Road, Taichung Industrial Park,
 Taichung, Taiwan
 台中市 407 工業區六路 8 號

TEL: 886-4-2355-8168

FAX: 886-4-2355-8166

E-mail: sales@powertip.com.tw

Http://www.powertip.com.tw

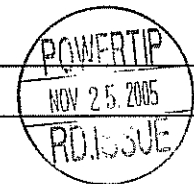

RECORDS OF REVISION

Date	Rev.	Description	Note	Design by
2005/02/17	0	Mass Production	—	Vodka
2005/06/21	A	Modify Drawing Pull Tape Direction Modify LCM Packaging Specifications	24 25	Vodka
2005/11/08	B	FPC cable length changed to 75mm, and improve the hardness of stiffener on FPC	—	Vodka

Total : 23 Page

Contents

1. SPECIFICATIONS

- 1.1 Features
- 1.2 Mechanical Specifications
- 1.3 Absolute Maximum Ratings
- 1.4 DC Electrical Characteristics
- 1.5 Optical Characteristics
- 1.6 Backlight Characteristics

2. MODULE STRUCTURE

- 2.1 Counter Drawing
- 2.2 Interface Pin Description
- 2.3 Timing Characteristics
- 2.4 Display Command

3. QUALITY ASSURANCE SYSTEM

- 3.1 Quality Assurance Flow Chart
- 3.2 Inspection Specification

4. RELIABILITY TEST

- 4.1 Reliability Test Condition

5. PRECAUTION RELATING PRODUCT HANDLING

- 5.1 Safety
- 5.2 Handling
- 5.3 Storage
- 5.4 Terms of Warranty

Appendix A : LCM Drawing

Appendix B : Package

Note : For detailed information please refer to IC data sheet : NOVATEK---NT7532H-BDT

1. SPECIFICATIONS

1.1 Features

Item	Standard Value
Display Type	128 * 64 Dots
LCD Type	FSTN, Positive, Transflective
Driver Condition	LCD Module :1/65 Duty, 1/9 Bias
Viewing Direction	6 O'clock
Backlight	LED B/L
Weight	12 g
Interface	8 bits parallel data input
Other(controller/driver IC)	NT7532H-BDT

1.2 Mechanical Specifications

Item	Standard Value	Unit
Outline Dimension	80.5 (W) × 45.0 (H) × 5.3 Max (T)	mm
Viewing Area	60.0 (L) * 32.6 (w)	mm
Active Area	55.01(L) * 27.49 (w)	mm
Dot Size	0.4 (W) × 0.4 (H)	mm
Dot Pitch	0.43 (W) × 0.43 (H)	mm

Note : For detailed information please refer to LCM drawing

1.3 Absolute Maximum Ratings

Item	Symbol	Condition	Min.	Max.	Unit
Power Supply Voltage	V _{DD}	-	-0.3	3.6	V
LCD Driver Supply Voltage	V _{SS} -V ₀	-	-0.3	14	V
Input Voltage	V _{IN}	-	-0.3	V _{DD} +0.3	V
Operating Temperature	T _{OP}	-	-20	70	°C
Storage Temperature.	T _{ST}	-	-30	80	°C
Storage Humidity	H _D	Ta < 40 °C	20	90	%RH

1.4 DC Electrical Characteristics

$V_{DD} = 2.85 \text{ V} \pm 0.15$, $V_{SS} = 0\text{V}$, $T_a = 25^\circ\text{C}$

Item	Symbol	Condition	Min.	Typ.	Max.	Unit
Logic Supply Voltage	V_{DD}	-	2.7	2.85	3.0	V
“H” Input Voltage	V_{IH}	-	$0.8 V_{DD}$	-	V_{DD}	V
“L” Input Voltage	V_{IL}	-	V_{SS}	-	$0.2 V_{DD}$	V
“H” Output Voltage	V_{OH}	-	$0.8 V_{DD}$	-	V_{DD}	V
“L” Output Voltage	V_{OL}	-	V_{SS}	-	$0.2 V_{DD}$	V
Supply Current	I_{DD}	$V_{DD} = 2.85 \text{ V}$	-	0.2	1	mA
LCM Driver Voltage	V_{OP}	$V_{SS} - V_0 (-20^\circ\text{C})$	8.0	8.1	8.2	V
		$V_{SS} - V_0 (25^\circ\text{C})$	7.9	8.0	8.1	
		$V_{SS} - V_0 (70^\circ\text{C})$	7.4	7.6	7.8	

1.5 Optical Characteristics

LCD Panel: 1/65 Duty, 1/9 Bias, $V_{LCD} = 8.0 \text{ V}$, $T_a = 25^\circ\text{C}$

Item	Symbol	Conditions	Min.	Typ.	Max.	Reference
View Angle	θ	$C \geq 2.0, \varnothing = 270^\circ$	-40°	-	40°	Notes 1
Contrast Ratio	CR	$\theta = -5^\circ, \varnothing = 270^\circ$	2	4	-	Note 3
Response Time(rise)	T_r	$\theta = -5^\circ, \varnothing = 270^\circ$	-	100 ms	150 ms	Note 2
Response Time(fall)	T_f	$\theta = -5^\circ, \varnothing = 270^\circ$	-	260 ms	390 ms	

Note 1.

Optical characteristics-2

Viewing angle

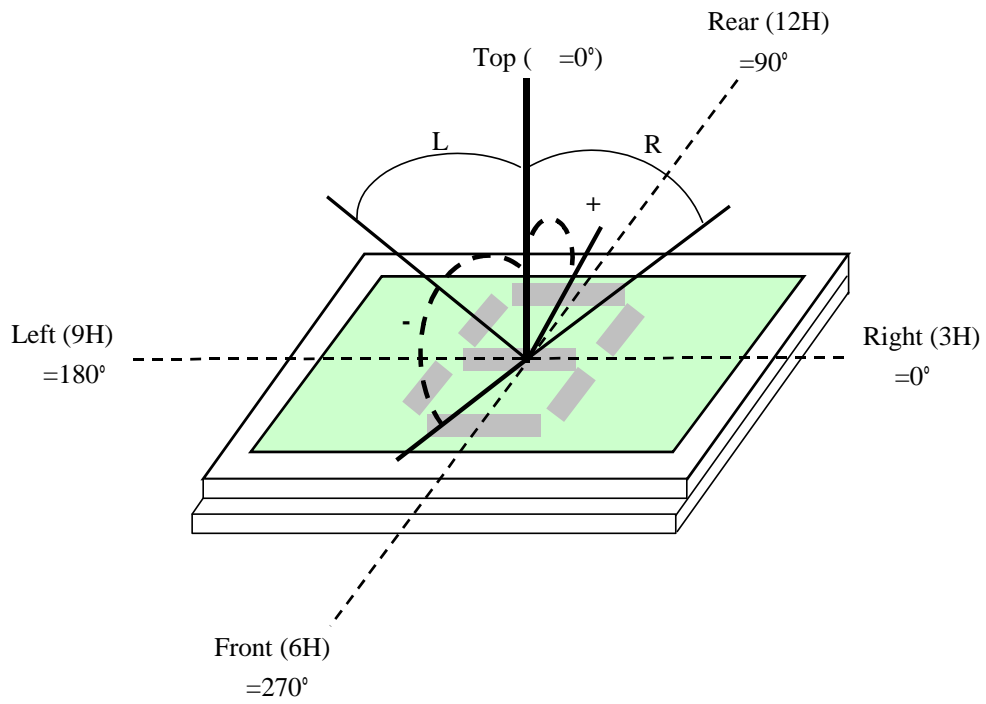

Viewing angle

Note 2.

Optical characteristics-3

Fig.2 Definition of response time

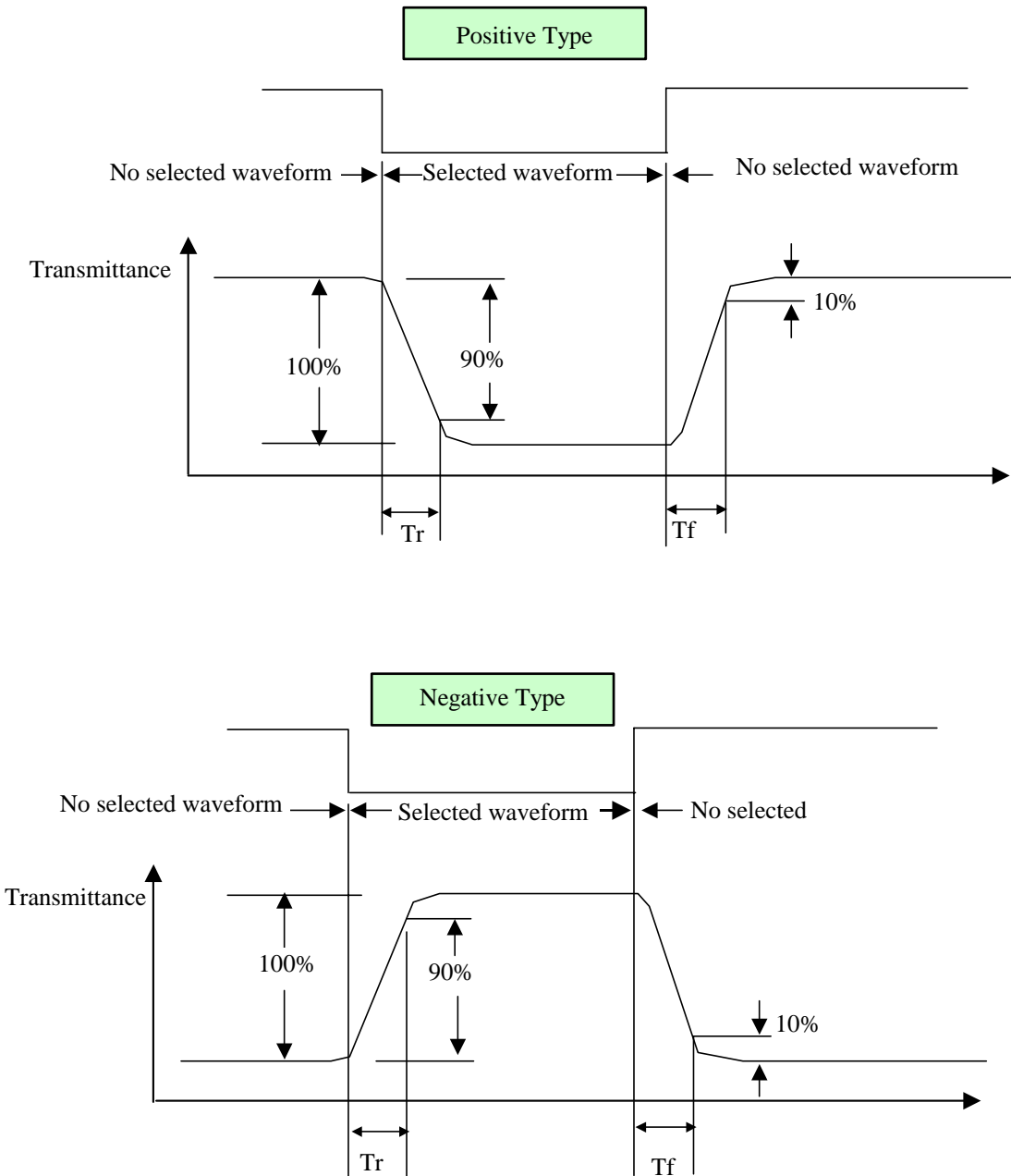

Electrical characteristics-2

2 Drive waveform

V_{op} : Drive voltage f_F : Frame frequency
 $1/B$: Bias f_D : Drive frequency
 N : Duty

(1) Selected waveform

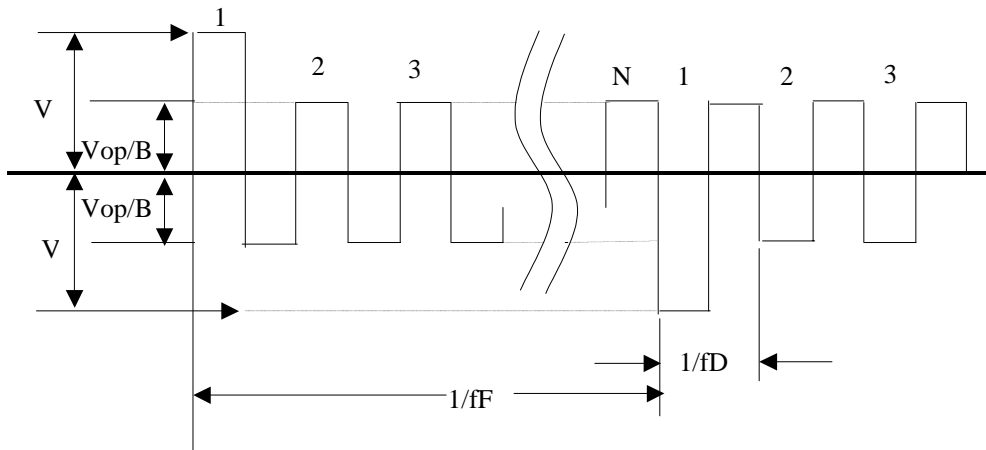

(2) Non- Selected waveform

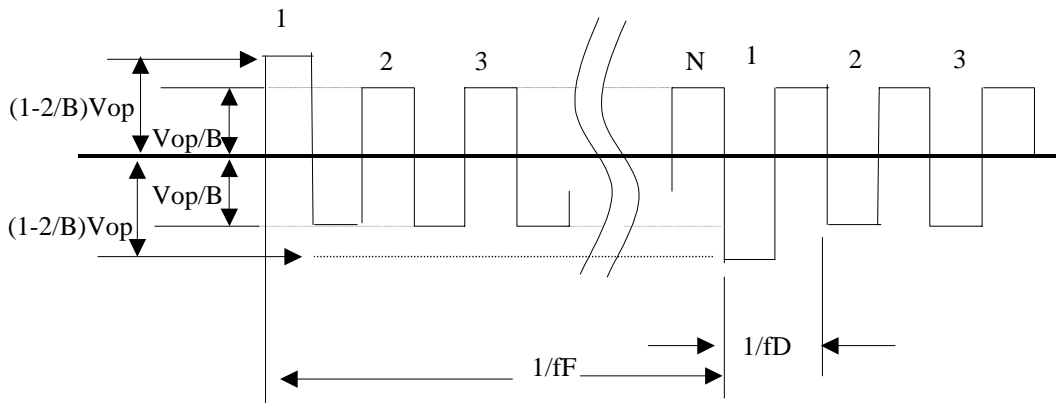

Note:

Frame frequency is defined as follows: Common side supply voltage peak - to - peak / 2 = 1 period

Note 3. : Definition of Vth

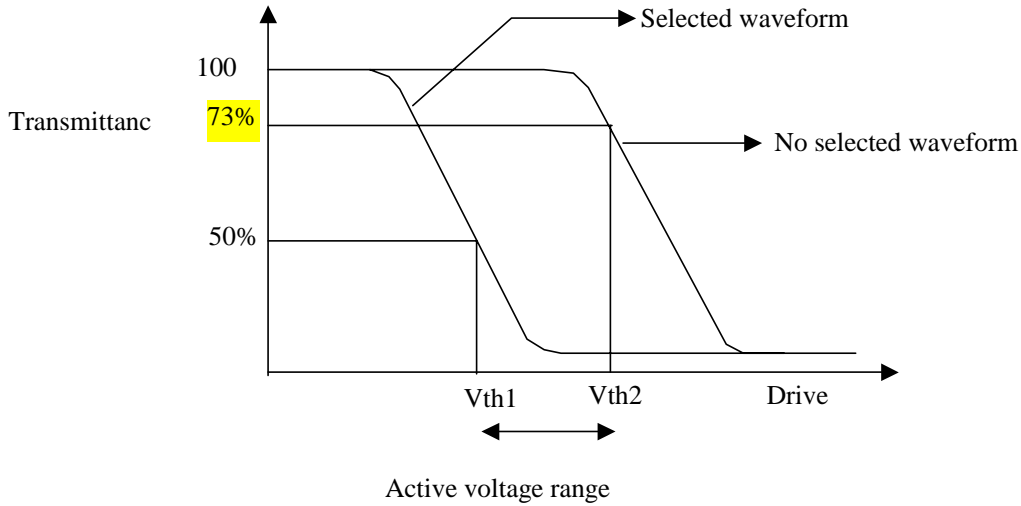

	Vth1	Vth2
View direction	10°	40°
Drive waveform	(Selected waveform)	(No selected waveform)
Transmittance	50%	73%

1 Contrast ratio
 = (Brightness in OFF state) / (Brightness in ON state)

Outline of Electro-Optical Characteristics Measuring System

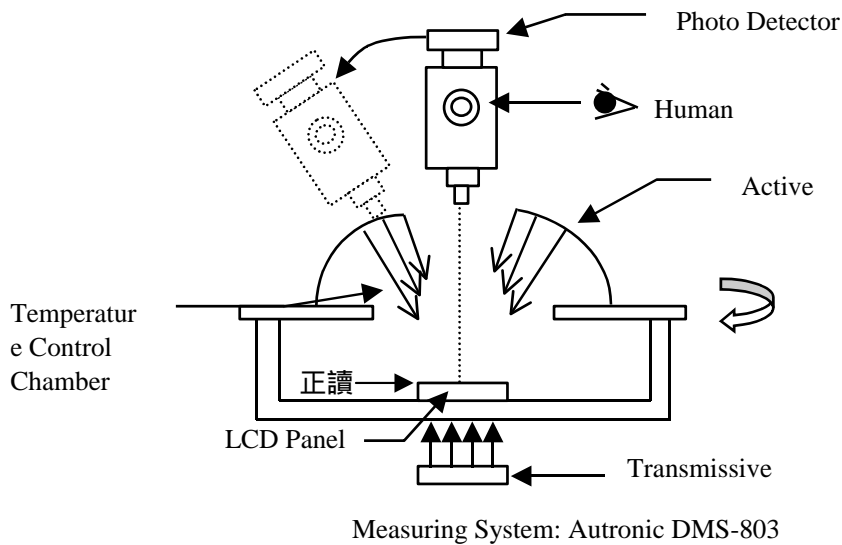

1.6 Backlight Characteristics

LCD Module with LED Backlight

Maximum Ratings

Item	Symbol	Condition	Min.	Max.	Unit
Forward Current	IF	Ta = 25 °C	-	160	mA
Reverse Voltage	VR	Ta = 25 °C	-	5	V
Power Dissipation	PO	Ta = 25 °C	-	0.4	W

Electrical / Optical Characteristics

Ta =25

Item	Symbol	Conditions	Min.	Typ.	Max.	Unit
Forward Voltage	VF	IF = 100mA	-	2.2	2.4	V
Reverse Current	IR	VR= 4 V	-	-	100	mA
Average Brightness (with LCD)*1	IV	IF = 100 mA	4	8		cd/m ²
Wavelength (Without LCD)*1	Hue	IF=100 mA	568	-	573	nm
Wavelength (with LCD)*1	Hue	IF=100 mA	569	-	575	nm
Uniformity *2	B	IF= 100 mA	70	-	-	%
Color	Y / G					

*1 This vaule will be changed while mass production.

*2 : $B=B(\text{min}) / B(\text{max})\%$

2. MODULE STRUCTURE

2.1 Counter Drawing

2.1.1 LCM Mechanical Diagram

* See Appendix

2.1.2 Block Diagram

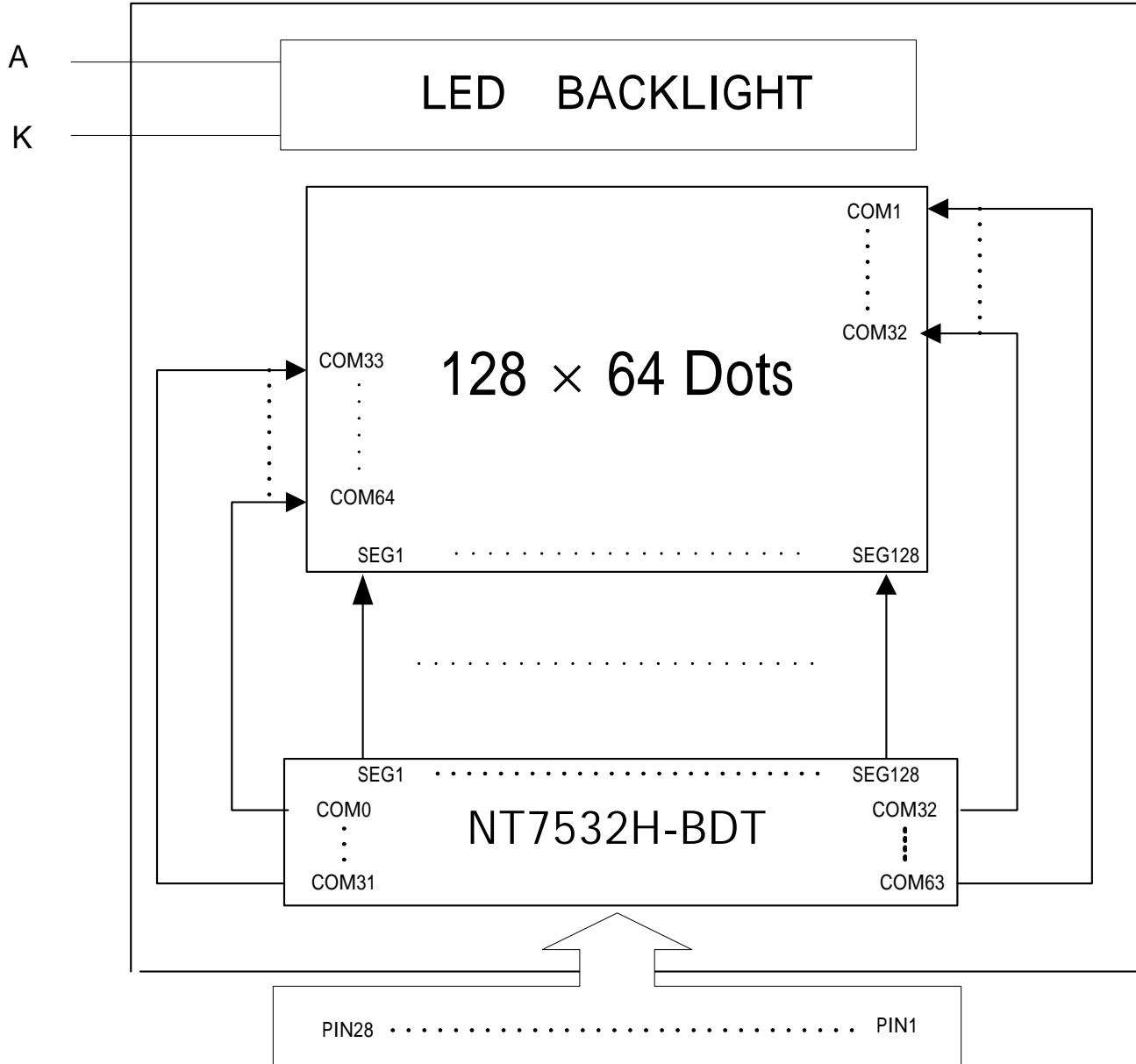

Prese refer interface pin description for detail

2.2 Interface Pin Description

Pin No.	Symbol	Function
1	CS1	This is the chip select signal. When CS1 = "L" then the chip select becomes active, and data/command I/O is enabled.
2	/RES	/RES is set to "L", the settings are initialized. The /RES signal level performs the reset operation.
3	A0	This is connect to the least significant bit of the normal MPU address bus, and it determines whether the data bits are data or a command. A0 = "H": Indicates that DB0 to DB7 are display data. A0 = "L": Indicates that DB0 to DB7 are control data.
4	/WR	When connected to an 8080 MPU, this is LOW active. This terminal connects to the 8080 MPU /WR signal. The signals on the data bus are latched at the rising edge of the /WR signal. When R/W = "H": Read. When R/W = "L" : Write.
5	/RD	When connected to an 8080 MPU, this is LOW active. This pin is connected to the /RD signal of the 8080 MPU, and the NT7532 series data bus is in an output status when this signal is "L".
6	DB0	This is an 8-bit bi-directional data bus that connects to an 8-bit or 16-bit standard MPU data bus. When the serial interface is selected (P/S = "L"), DB7 serves as the serial data input terminal (SI) and DB6 serves as the serial clock input terminal (SCL). At the same time, DB0 to DB5 are set to high impedance. When the chip select is inactive, DB0 to DB7 are set to high impedance.
7	DB1	
8	DB2	
9	DB3	
10	DB4	
11	DB5	
12	DB6	
13	DB7	
14	V _{DD}	Power Supply (V _{DD} =2.85V)
15	V _{SS}	Power Supply (V _{SS} =0)
16	VOUT	DC/DC voltage converter output
17	CAP3+	Capacitor 3+ pad for internal DC/DC voltage converter

18	CAP1-	Capacitor 1- pad for internal DC/DC voltage converter
19	CAP1+	Capacitor 1+ pad for internal DC/DC voltage converter
20	CAP2+	Capacitor 2+ pad for internal DC/DC voltage converter
21	CAP2-	Capacitor 2- pad for internal DC/DC voltage converter
22	V1	<p>LCD driver supply voltages The voltage determined by LCD cell is cell impedance-converted by a resistive driver or an operational amplifier for application. Voltages should be according the following relationship; $V0 \geq V1 \geq V2 \geq V3 \geq V4 \geq VSS$ When the internal power circuit is active, these voltages are generated as following table according to the state of LCD Bias command.</p>
23	V2	
24	V3	
25	V4	
26	V0	
27	LCD_ID	no connection
28	IRS	<p>This terminal selects the resistors for the V0 voltage level adjustment. IRS = "H": Use the internal resistors. IRS = "L": Do not use the internal resistors. The V0 voltage level is regulated by an external resistive Voltage divider attached to the VR terminal. This pin is Enabled only when the master operation mode is selected It is fixed to either "H" or "L" when the slave operation mode is selected</p>

A	+	Power supply LED backlight anode input(+)
K	-	Power supply LED backlight cathode input(-)

2.3 Timing Characteristics

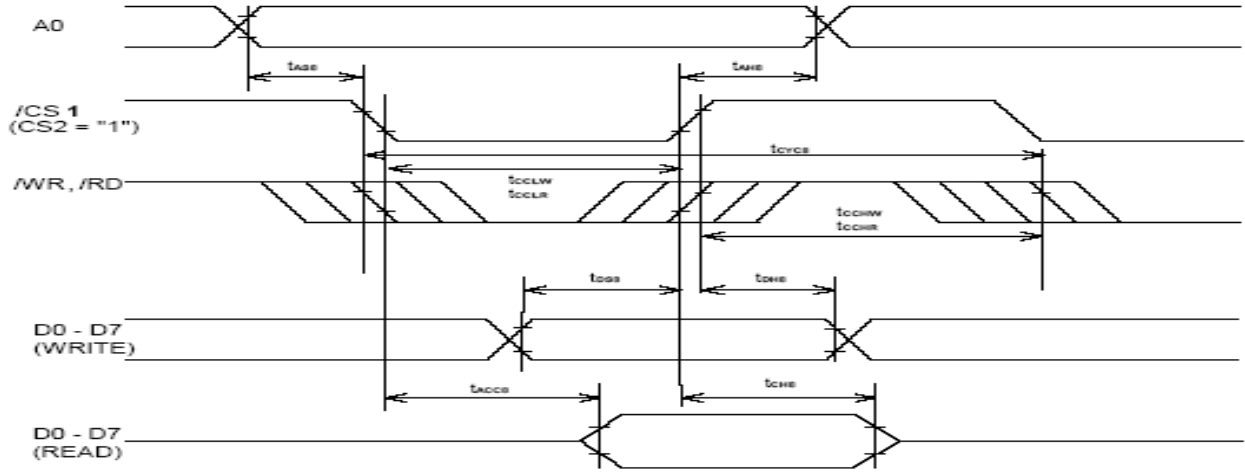

($V_{DD} = 2.7$ to 3.0 V)

Parameter	Symbol	Min.	Typ.	Max.	Unit	Conditions
Address hold time	t_{AH8}	0			ns	
Address setup time	t_{AS8}	0				
System cycle time	t_{CYC8}	300				
Control L pulse width (/WR)	t_{CCLW}	90				
Control L pulse width (/RD)	t_{CCLR}	120				
Control L pulse width (/WR)	t_{CCHW}	120				
Control L pulse width (/RD)	t_{CCHR}	60				
Data setup time	t_{DS8}	40				
Data hold time	t_{DH8}	15				
/RD access time	t_{ACC8}			140		
Output disable time	t_{CH8}	10		100		$C_L = 100\text{pf}$

*1. The input signal rise time and fall time ($t_{r,f}$) is specified at 15ns or less. When the system cycle time is extremely fast, ($t_{r,f}$) ($t_{CYC8} - t_{CCLW} - t_{CCHW}$) for ($t_{r,f}$) ($t_{CYC8} - t_{CCLR} - t_{CCHR}$) are specified.

*2. All timing is specified using 20% and 80% of V_{DD} as the reference.

*3. t_{CCLW} and t_{CCLR} are specified as the overlap between CS1 being " L " and /WR and /RD being at the " L " level.

Reset Timing

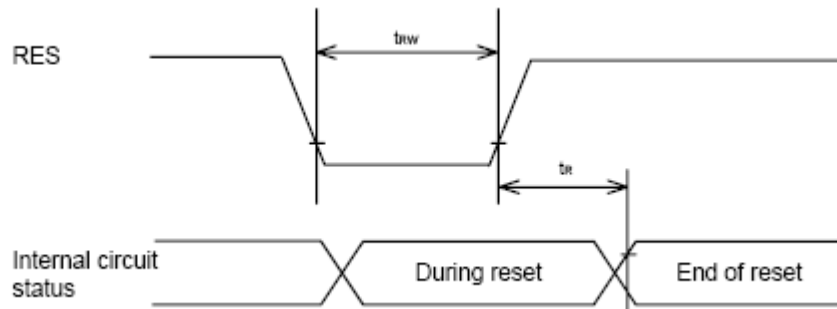

($V_{DD} = 2.7$ to 3.0 V)

Parameter	Symbol	Min.	Typ.	Max.	Unit	Conditions
Reset time	t_R			1.0	us	
Reset low pulse width	t_{RW}	1.0				

2.4 Display Command

Command	Command Code											Function
	A0	\overline{RD}	\overline{WR}	D7	D6	D5	D4	D3	D2	D2	D0	
(1) Display ON/OFF	0	1	0	1	0	1	0	1	1	1	0	LCD display ON/OFF 0:OFF, 1:ON
											1	
(2) Display start line set	0	1	0	0	1	Display start address					Sets the display RAM display start line address	
(3) Page address set	0	1	0	1	0	1	1	Page address				Sets the display RAM page address
(4) Column address set upper bit	0	1	0	0	0	0	0	1	Most significant column address			Sets the most significant 4 bits of the display RAM column address.
Column address set lower bit	0	1	0	0	0	0	0	0	Least significant column address			Sets the least significant 4 bits of the display RAM column address.
(5) Status read	0	0	1	Status				0	0	0	0	Reads the status data
(6) Display data write	1	1	0	Write data							Writes to the display RAM	
(7) Display data read	1	0	1	Read data							Reads from the display RAM	
(8) ADC select	0	1	0	1	0	1	0	0	0	0	0	Sets the display RAM address SEG output correspondence 0: normal, 1: reverse
											1	
(9) Display normal/ reverse	0	1	0	1	0	1	0	0	1	1	0	Sets the LCD display RAM normal/reverse 0: normal, 1: reverse
											1	
(10) Display all points ON/OFF	0	1	0	1	0	1	0	0	1	0	0	Display all points 0: normal display, 1: all points ON
											1	
(11) LCD bias set	0	1	0	1	0	1	0	0	0	1	0	Sets the LCD drive voltage bias ratio 0: 1/9, 1:1/7
											1	
(12) Read/modify/write	0	1	0	1	1	1	0	0	0	0	0	Column address increment At write: +1 At read: 0
(13) End	0	1	0	1	1	1	0	1	1	1	0	Clear read/modify/write
(14) Reset	0	1	0	1	1	1	0	0	0	1	0	Internal reset

(15) Common output mode select	0	1	0	1	1	0	0	0	*	*	*	Select COM output scan direction 0: normal direction, 1: reverse direction	
								1					
(16) Power control set	0	1	0	0	0	1	0	1	Operating mode				Select internal power supply operating mode
(17) V5 voltage regulator internal resistor ratio set	0	1	0	0	0	1	0	0	Resistor ratio				Select internal resistor ratio (Rb/Ra) mode
(18) Electronic volume mode set	0	1	0	1	0	0	0	0	0	0	1		
Electronic volume register set	0	1	0	*	*	Electronic volume value						Set the V5 output voltage electronic volume register.	
(19) Static indicator ON/OFF	0	1	0	1	0	1	0	1	1	0	0	0: OFF 1: ON	
											1		
Static indicator register set	1	0	1	*	*	*	*	*	*			Mode	Set the flashing mode
(20) Power saver											Display OFF and display all points ON compound command		
(21) NOP	0	1	0	1	1	1	0	0	0	1	1	Command for non-operation	
(22) Test	0	1	0	1	1	1	1	*	*	*	*	Command for IC test. Do not use this command	

(Note) *: disabled data

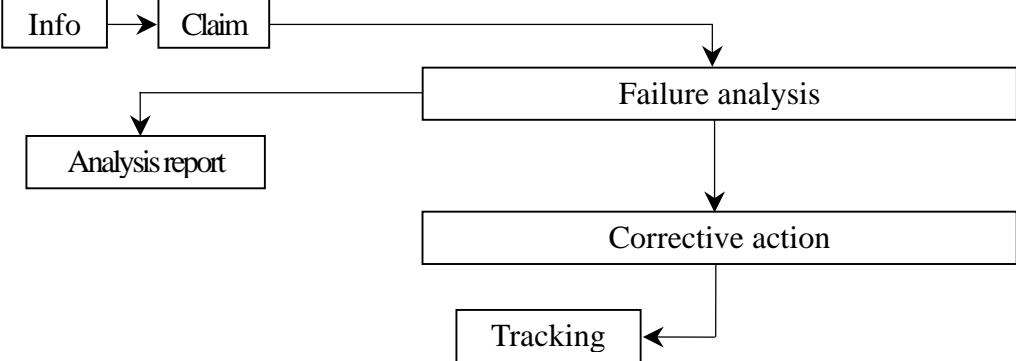
Item	Customer	Sales	R&D	Q.A	Manufacturing	Product control	Purchase	Inventory control
Sales Service	 <pre> graph TD Info[Info] --> Claim[Claim] Claim --> Failure[Failure analysis] Failure --> Report[Analysis report] Failure --> Action[Corrective action] Action --> Tracking[Tracking] </pre>							
Q.A Activity	1. ISO 9001 Maintenance Activities 3. Equipment calibration 5. Standardization Management				2. Process improvement proposal 4. Education And Training Activities			

3.2 Inspection Specification

Inspection Standard : MIL-STD-105E Table Normal Inspection Single Sampling Level II

Equipment : Gauge , MIL-STD , Powertip Tester , Sample

IQC Defect Level : Major Defect AQL 0.4; Minor Defect AQL 1.5

FQC Defect Level : 100% Inspection

OUT Going Defect Level : Sampling

Specification :

NO	Item	Specification	Judge	Level
1	Part Number	The part number is inconsistent with work order of production	N.G.	Major
2	Quantity	The quantity is inconsistent with work order of production	N.G.	Major
3	Electronic characteristics of LCM $A = (L + W) / 2$	The display lacks of some patterns.	N.G.	Major
		Missing line.	N.G.	Major
		The size of missing dot, A is > 1/2 Dot size	N.G.	Major
		There is no function.	N.G.	Major
		Output data is error	N.G.	Major
4	Appearance of LCD $A = (L + W) / 2$	Material is different with work order of production	N.G.	Major
		LCD is assembled in inverse direction	N.G.	Major
		Bezel is assembled in inverse direction	N.G.	Major
		Shadow is within LCD viewing area + 0.5 mm	N.G.	Major
		The diameter of dirty particle, A is > 0.4 mm	N.G.	Minor
	Dirty particle (Including scratch, bubble)	Dirty particle length is > 3.0mm, and 0.01mm < width ≤ 0.05mm	N.G.	Minor
		Display is without protective film	N.G.	Minor
		Conductive rubber is over bezel 1mm	N.G.	Minor
		Polarizer exceeds over viewing area of LCD	N.G.	Minor
		Area of bubble in polarizer, A > 1.0mm, the number of bubble is > 1 piece.	N.G.	Minor
		0.4mm < Area of bubble in polarizer, A < 1.0mm, the number of bubble is > 4 pieces.	N.G.	Minor
5	Appearance of PCB $A = (L + W) / 2$	Burned area or wrong part number is on PCB	N.G.	Major
		The symbol, character, and mark of PCB are unidentifiable.	N.G.	Minor
		The stripped solder mask , A is > 1.0mm	N.G.	Minor
		0.3mm < stripped solder mask or visible circuit, A < 1.0mm, and the number is ≥ 4 pieces	N.G.	Minor
		There is particle between the circuits in solder mask	N.G.	Minor
		The circuit is peeled off or cracked	N.G.	Minor
		There is any circuits risen or exposed.	N.G.	Minor
		0.2mm < Area of solder ball, A is ≤ 0.4mm	N.G.	Minor
		The number of solder ball is ≥ 3 pieces	N.G.	Minor
The magnitude of solder ball, A is > 0.4mm.	N.G.	Minor		

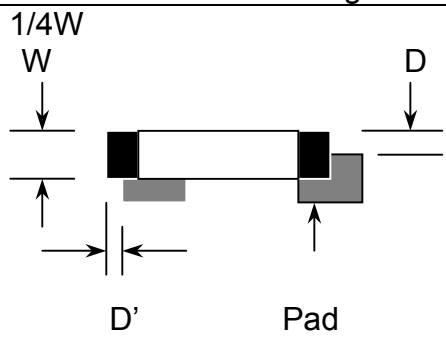
NO	Item	Specification	Judge	Level
6	Appearance of molding $A=(L+W)/2$	The shape of modeling is deformed by touching.	N.G.	Major
		Insufficient epoxy: Circuit or pad of IC is visible	N.G.	Minor
		Excessive epoxy: Diameter of modeling is > 2.0mm or height is > 2.5mm	N.G.	Minor
		The diameter of pinhole in modeling, A is > 0.2mm.	N.G.	Minor
7	Appearance of frame $A=(L+W)/2$	The folding angle of frame must be $> 45^{\circ} + 10^{\circ}$	N.G.	Minor
		The area of stripped electroplate in top-view of frame, A is > 1.0mm.	N.G.	Minor
		Rust or crack is (Top view only)	N.G.	Minor
		The scratched width of frame is > 0.06mm. (Top view only)	N.G.	Minor
8	Electrical characteristic of backlight $A=(L+W)/2$	The color of backlight is nonconforming	N.G.	Major
		Backlight can't work normally.	N.G.	Major
		The LED lamp can't work normally	N.G.	Major
		The unsoldering area of pin for backlight, A is > 1/2 solder joint area.	N.G.	Minor
		The height of solder pin for backlight is > 2.0mm	N.G.	Minor
10	Assembly parts $A=(L+W)/2$	The mark or polarity of component is unidentifiable.	N.G.	Minor
		The height between bottom of component and surface of the PCB is floating > 0.7mm	N.G.	Minor
		$D > 1/4W$  <p>The diagram illustrates a component on a PCB pad. W is the component width, D is the side overhang, and D' is the end solder joint width. The pad is labeled 'Pad'.</p>	N.G.	Minor
		End solder joint width, D' is > 50% width of component termination or width of pad	N.G.	Minor
		Side overhang, D is > 25% width of component termination.	N.G.	Minor
		Component is cracked, deformed, and burned, etc.	N.G.	Minor
		The polarity of component is placed in inverse direction.	N.G.	Minor
		Maximum fillet height of solder extends onto the component body or minimum fillet height is < 0.5mm.	N.G.	Minor

4. RELIABILITY TEST

4.1 Reliability Test Condition

NO	Item	Test Condition	
1	High Temperature Storage	Storage at $80 \pm 2^{\circ}\text{C}$ 96~100 hrs Surrounding temperature, then storage at normal condition 4hrs	
2	Low Temperature Storage	Storage at $-30 \pm 2^{\circ}\text{C}$ 96~100 hrs Surrounding temperature, then storage at normal condition 4hrs	
3	High Temperature /Humidity Storage	1.Storage 96~100 hrs $60 \pm 2^{\circ}\text{C}$, 90~95%RH surrounding temperature, then storage at normal condition 4hrs. (Excluding the polarizer). or 2.Storage 96~100 hrs $40 \pm 2^{\circ}\text{C}$, 90~95%RH surrounding temperature, then storage at normal condition 4 hrs.	
4	Temperature Cycling	$-20^{\circ}\text{C} \rightarrow 25^{\circ}\text{C} \rightarrow 70^{\circ}\text{C} \rightarrow 25^{\circ}\text{C}$ $\leftarrow (30\text{mins}) (5\text{mins}) (30\text{mins}) (5\text{mins}) \rightarrow$ <p style="text-align: center;">10 Cycle</p>	
5	Vibration	10~55Hz (1 minute) 1.5mm X,Y and Z direction * (each 2hrs)	
6	ESD Test	Air Discharge: Apply 8 KV with 10 times discharge for each polarity +/-	Contact Discharge: Apply 5KV with 10 times discharge for each polarity +/-
		Testing location : With customer application	
7	Drop Test	Packing Weight (Kg)	Drop Height (cm)
		0 ~ 45.4	122
		45.4 ~ 90.8	76
		90.8 ~ 454	61
		Over 454	46

5. PRECAUTION RELATING PRODUCT HANDLING

5.1 SAFETY

- 5.1.1 If the LCD panel breaks , be careful not to get the liquid crystal to touch your skin.
- 5.1.2 If the liquid crystal touches your skin or clothes , please wash it off immediately by using soap and water.

5.2 HANDLING

- 5.2.1 Avoid any strong mechanical shock which can break the glass.
- 5.2.2 Avoid static electricity which can damage the CMOS LSI—When working with the module , be sure to ground your body and any electrical equipment you may be using.
- 5.2.3 Do not remove the panel or frame from the module.
- 5.2.4 The polarizing plate of the display is very fragile. So , please handle it very carefully, do not touch , push or rub the exposed polarizing with anything harder than an HB pencil lead (glass , tweezers , etc.)
- 5.2.5 Do not wipe the polarizing plate with a dry cloth , as it may easily scratch the surface of plate.
- 5.2.6 Do not touch the display area with bare hands , this will stain the display area.
- 5.2.7 Do not use ketonics solvent & aromatic solvent. Use with a soft cloth soaked with a cleaning naphtha solvent.
- 5.2.8 To control temperature and time of soldering is $280 \pm 10^{\circ}\text{C}$ and 3-5 sec.
- 5.2.9 To avoid liquid (include organic solvent) stained on LCM.

5.3 STORAGE

- 5.3.1 Store the panel or module in a dark place where the temperature is $25^{\circ}\text{C} \pm 5^{\circ}\text{C}$ and the humidity is below 65% RH.
- 5.3.2 Do not place the module near organics solvents or corrosive gases.
- 5.3.3 Do not crush , shake , or jolt the module.

5.4 TERMS OF WARRANTY

5.4.1 Applicable warrant period

The period is within thirteen months since the date of shipping out under normal using and storage conditions.

5.4.2 Unaccepted responsibility

This product has been manufactured to your company's specification as a part for use in your company's general electronic products. It is guaranteed to perform according to delivery specifications. For any other use apart from general electronic equipment, we cannot take responsibility if the product is used in nuclear power control equipment, aerospace equipment , fire and security systems or any other applications in which there is a direct risk to human life and where extremely high levels of reliability are required.

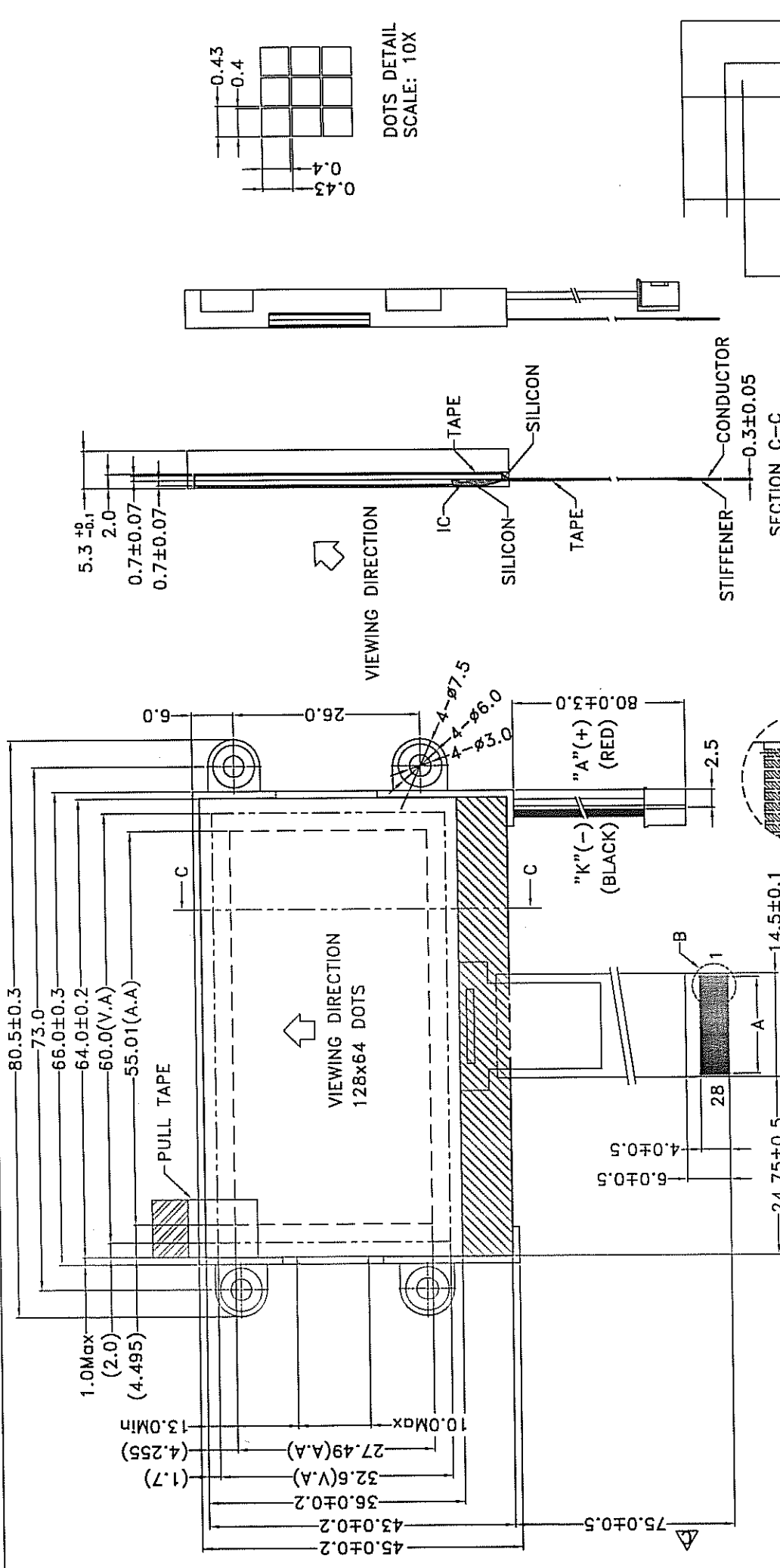

- NOTE:**
1. THE TOLERANCE UNLESS CLASSIFIED ±0.2mm
 2. LCD TYPE : FSTN
 3. VIEWING DIRECTION : 6 O'CLOCK
 4. DISPLAY MODE : POSITIVE / TRANSFLECTIVE
 5. A=PO.5x27=13.5±0.1
 6. IC=NT7532



久正光電股份有限公司 POWER TIP TECHNOLOGY CORPORATION		APPROVED	CHECKER	DRAWN
SCALE: 1/0.8	UNIT: mm	9.11.23	張慶源	鄧仕田 李美倫
圖面名稱	PE12864LRF-018-H			
圖面編號	PE-04011-002	EDI	C	
Nov/08/05'				
Sep/26/05'				
Jun/21/05'				
DESCRIPTION	FPC cable length changed to 75mm, and improve the hardness of stiffener on FPC			
REV	Modify LCM packaging specifications			
	Modify LCM packaging specifications			

LCM Model	PE12864LRF-018-H
版次Ver.C	

LCM包裝規格書

LCM Packaging Specifications

(For Tray)

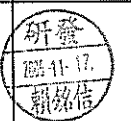
Approve	Check	Contact
		

1. 包裝材料規格表 (Packaging Material) : (per carton)

No.	Item	Model	Dimensions (mm)	Quantity
1	成品 (LCM)	PE12864LRF-018-H	64.0 X 43.0	6048
2	多層薄膜(1)POF	OTFILM0BA03ABA	19"X350X0.015	126
3	TRAY 盤 (2)	TY128064IOTZ0A	295 X 245 X 16	1008
4	海綿墊(3)	OTFOAM00006ABA	290 X 240 X 10	252
5	C3內盒(4)Product Box	BX31025510AABA	310 X 255 X 100	126
6	外紙箱(5)Carton	BX52732536CCBA	527 X 325 X 360	21
7	棧板(6)PALLET	OTPALLET002ABA	1200 X 1000 X 130	1
8				
9				

2. 單箱數量規格表 (Packaging Specifications and Quantity) :

(1) LCM quantity per box : no per tray	6	x no of tray	8	=	48
(2) Total LCM quantity in carton : quantity per box	48	x no of boxes	6	=	288
(2) Total LCM quantity in pallet : quantity per carton	288	x no of cartons	21	=	6048

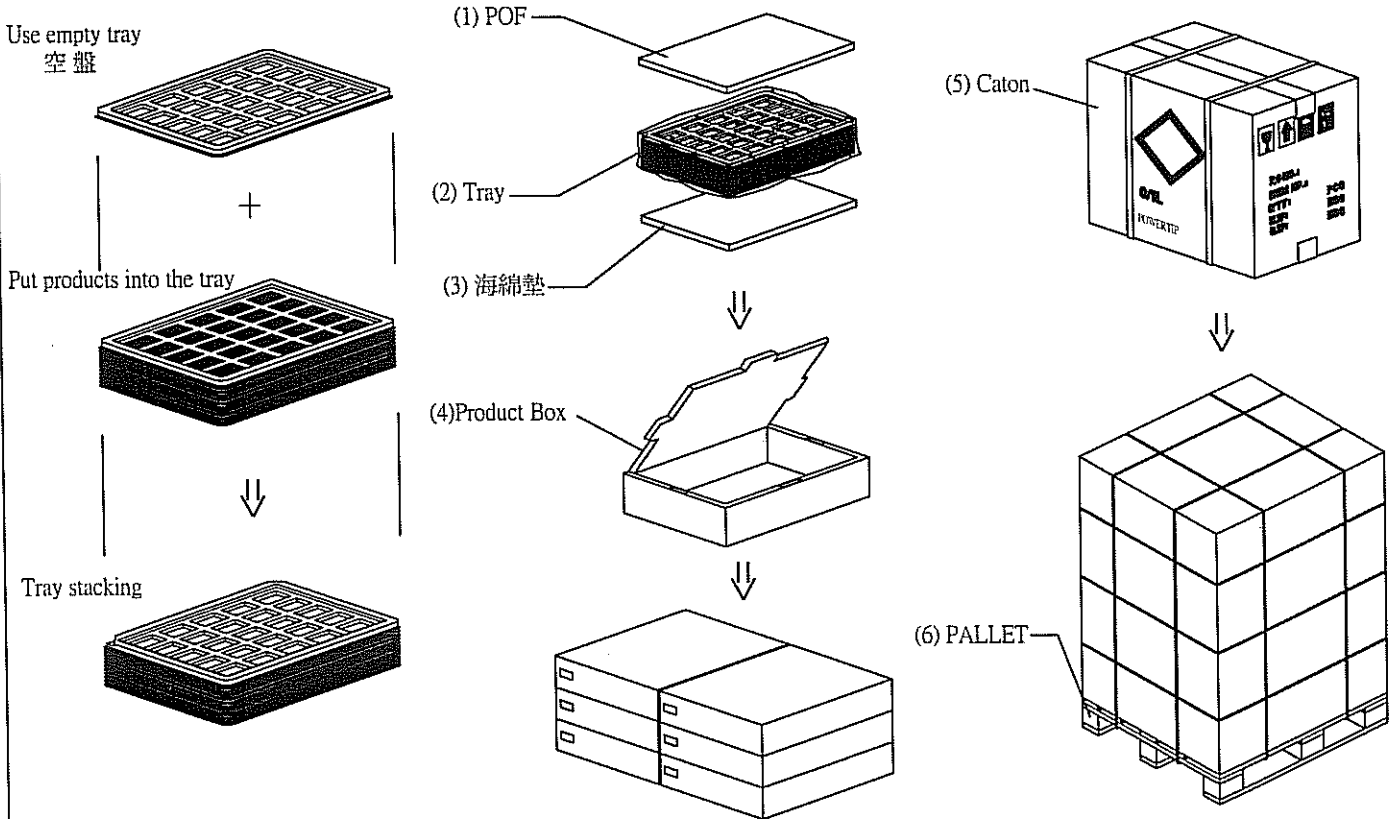

特 記 事 項 (REMARK)

1. Label Specifications :

TYPE	PE12864LRF-018-H
LOT.NO	XXXXXXX
QTY	48 PCS
DATE	XXXX.XX.XX
NOTE	LSP350T PE12864 Y/G

2. Rotate tray 180 degrees and place on top of stack. (TRAY盤相疊時,需旋轉180度)
3. It's also suitable to Panel (可適用於單品包裝)
4. 外箱擺放方式: 一層擺放7箱外箱, 共3層 7箱x3層=21箱外箱
5. 不滿一棧板之尾數箱, 不須用棧板出貨
6. 外圍加打包帶及外部封塑膠膜