

DUAL N-CHANNEL MATCHED MOSFET PAIR

© 1998 Advanced Linear Devices, Inc. 415 Tasman Drive, Sunnyvale, California 94089 -1706 Tel: (408) 747-1155 Fax: (408) 747-1286 http://www.aldinc.com

GENERAL DESCRIPTION

The ALD1101 is a monolithic dual N-channel matched transistor pair intended for a broad range of analog applications. These enhancement-mode transistors are manufactured with Advanced Linear Devices' enhanced ACMOS silicon gate CMOS process.

The ALD1101 offers high input impedance and negative current temperature coefficient. The transistor pair is matched for minimum offset voltage and differential thermal response, and it is designed for switching and amplifying applications in +2V to +12V systems where low input bias current, low input capacitance and fast switching speed are desired. Since these are MOSFET devices, they feature very large (almost infinite) current gain in a low frequency, or near DC, operating environment. When used with an ALD1102, a dual CMOS analog switch can be constructed. In addition, the ALD1101 is intended as a building block for differential amplifier input stages, transmission gates, and multiplexer applications.

The ALD1101 is suitable for use in precision applications which require very high current gain, beta, such as current mirrors and current sources. The high input impedance and the high DC current gain of the Field Effect Transistors result in extremely low current loss through the control gate. The DC current gain is limited by the gate input leakage current, which is specified at 50pA at room temperature. For example, DC beta of the device at a drain current of 5mA at 25°C is $5\text{mA}/50\text{pA} = 100,000,000$.

FEATURES

- Low threshold voltage of 0.7V
- Low input capacitance
- Low Vos grades -- 2mV, 5mV, 10mV
- High input impedance -- $10^{12}\Omega$ typical
- Negative current (IDS) temperature coefficient
- Enhancement-mode (normally off)
- DC current gain 10^9

ORDERING INFORMATION

Operating Temperature Range*		
-55°C to +125°C	0°C to +70°C	0°C to +70°C
8-Pin CERDIP Package	8-Pin Plastic Dip Package	8-Pin SOIC Package
ALD1101 DA	ALD1101A PA ALD1101B PA ALD1101 PA	ALD1101 SA

* Contact factory for industrial temperature range.

APPLICATIONS

- Precision current mirrors
- Precision current sources
- Analog switches
- Choppers
- Differential amplifier input stage
- Voltage comparator
- Data converters
- Sample and Hold
- Analog inverter

PIN CONFIGURATION

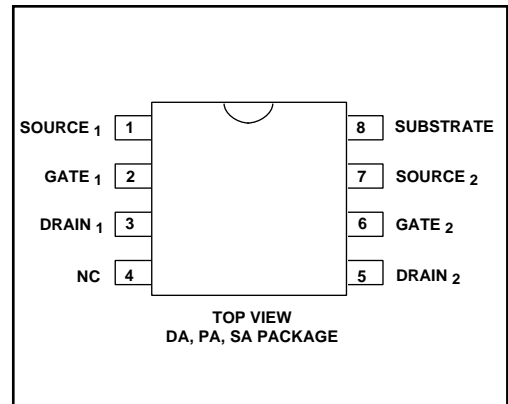

BLOCK DIAGRAM

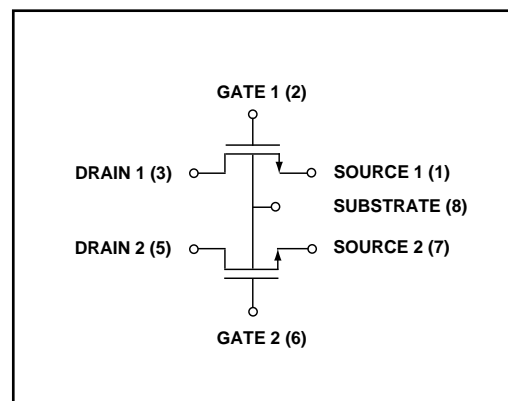

ABSOLUTE MAXIMUM RATINGS

Drain-source voltage, V_{DS}	_____	13.2V
Gate-source voltage, V_{GS}	_____	13.2V
Power dissipation	_____	500 mW
Operating temperature range	PA, SA package _____	0°C to +70°C
	DA package _____	-55°C to +125°C
Storage temperature range	_____	-65°C to +150°C
Lead temperature, 10 seconds	_____	+260°C

OPERATING ELECTRICAL CHARACTERISTICS

$T_A = 25^\circ\text{C}$ unless otherwise specified

Parameter	Symbol	ALD 1101A			ALD1101B			ALD1101			Unit	Test Conditions
		Min	Typ	Max	Min	Typ	Max	Min	Typ	Max		
Gate Threshold Voltage	V_T	0.4	0.7	1.0	0.4	0.7	1.0	0.4	0.7	1.0	V	$I_{DS} = 10\mu\text{A}$ $V_{GS} = V_{DS}$
Offset Voltage $V_{GS1} - V_{GS2}$	V_{OS}			2			5			10	mV	$I_{DS} = 100\mu\text{A}$ $V_{GS} = V_{DS}$
Gate Threshold Temperature Drift	TC_{VT}		-1.2			-1.2			-1.2		mV/°C	
On Drain Current	$I_{DS(ON)}$	25	40		25	40		25	40		mA	$V_{GS} = V_{DS} = 5\text{V}$
Transconductance	G_{fs}	5	10		5	10		5	10		mmho	$V_{DS} = 5\text{V}$ $I_{DS} = 10\text{mA}$
Mismatch	ΔG_{fs}		0.5			0.5			0.5		%	
Output Conductance	G_{OS}		200			200			200		μmho	$V_{DS} = 5\text{V}$ $I_{DS} = 10\text{mA}$
Drain Source ON Resistance	$R_{DS(ON)}$		50	75		50	75		50	75	Ω	$V_{DS} = 0.1\text{V}$ $V_{GS} = 5\text{V}$
Drain Source ON Resistance Mismatch	$\Delta R_{DS(ON)}$		0.5			0.5			0.5		%	$V_{DS} = 0.1\text{V}$ $V_{GS} = 5\text{V}$
Drain Source Breakdown Voltage	BV_{DSS}	12			12			12			V	$I_{DS} = 10\mu\text{A}$ $V_{GS} = 0\text{V}$
Off Drain Current	$I_{DS(OFF)}$		0.1	4 4		0.1	4 4		0.1	4 4	nA μA	$V_{DS} = 12\text{V}$ $V_{GS} = 0\text{V}$ $T_A = 125^\circ\text{C}$
Gate Leakage Current	I_{GSS}		1	50 10		1	50 10		1	50 10	pA nA	$V_{DS} = 0\text{V}$ $V_{GS} = 12\text{V}$ $T_A = 125^\circ\text{C}$
Input Capacitance	C_{ISS}		6	10		6	10		6	10	pF	

TYPICAL PERFORMANCE CHARACTERISTICS

OUTPUT CHARACTERISTICS

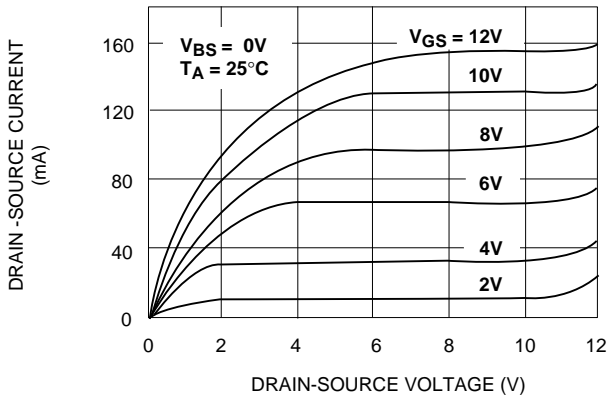

LOW VOLTAGE OUTPUT CHARACTERISTICS

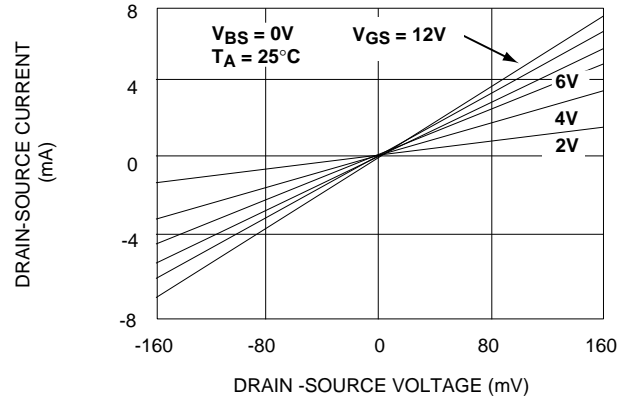

FORWARD TRANSCONDUCTANCE vs. DRAIN-SOURCE VOLTAGE

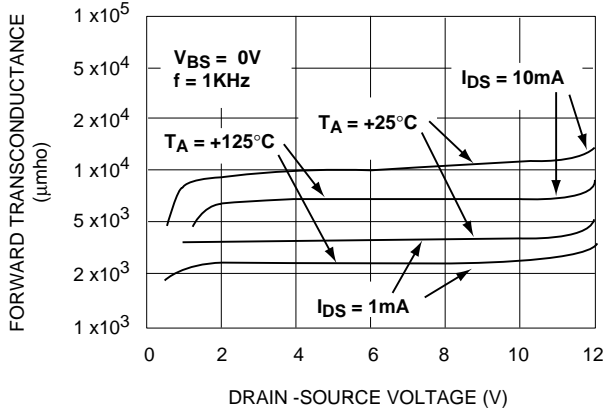

TRANSFER CHARACTERISTIC WITH SUBSTRATE BIAS

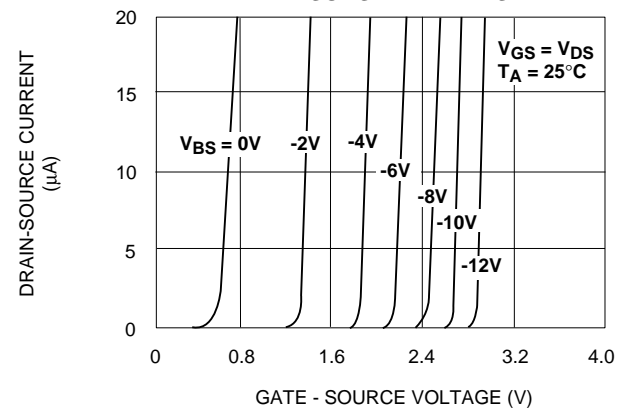

RDS (ON) vs. GATE - SOURCE VOLTAGE

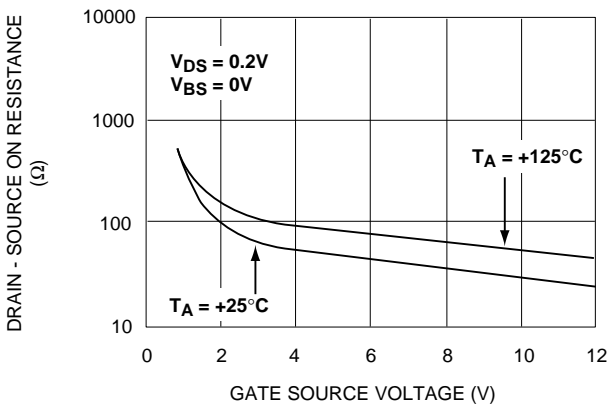

OFF DRAIN - CURRENT vs. TEMPERATURE

