

Features

- High Tuning Ratio
- Low Series Resistance
- SOD-323 Package
- Designed for High Volume, Low Cost Applications
- Available in Tape and Reel Packaging

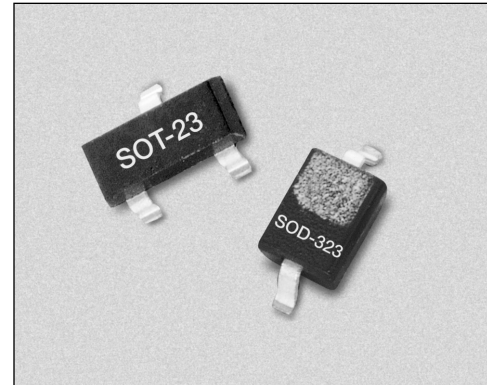

Description

The SMV1135-011 is a surface mount varactor diode in the SOD-323 plastic package. It is designed for very high capacitance tuning ratio while having low series resistance, which makes this device especially attractive for wideband VCO applications.

Absolute Maximum Ratings

Characteristic	Value
Forward Current (I_F)	20 mA
Power Dissipation (P_D)	250 mW
Storage Temperature (T_{ST})	-55°C to +150°C
Operating Temperature (T_{OP})	-55°C to +125°C

Single	Common Cathode
SOD-323	SOT-23
SMV1135-011	SMV1135-004

Electrical Specifications at 25°C

Parameter	Condition	Min.	Typ.	Max.	Unit
Reverse Current (I_R)	$V_R = 21\text{ V}$			20.00	nA
Capacitance (C_T)	$C_T @ 1\text{ V}, V_R = 1\text{ V}, F = 1\text{ MHz}$	8.20		10.00	pF
Capacitance Ratio (C_{TR})	$C_T(1\text{ V})/C_T(3\text{ V})$	1.47		1.76	
Capacitance Ratio (C_{TR})	$C_T(1\text{ V})/C_T(9\text{ V})$	3.70		4.50	
Series Resistance (R_S)	$V_R = 1\text{ V}, F = 500\text{ MHz}$			1.20	Ω
Breakdown Voltage (V_{BR})	$I_R = 10\ \mu\text{A}$	28.00			V

Typical Performance Data

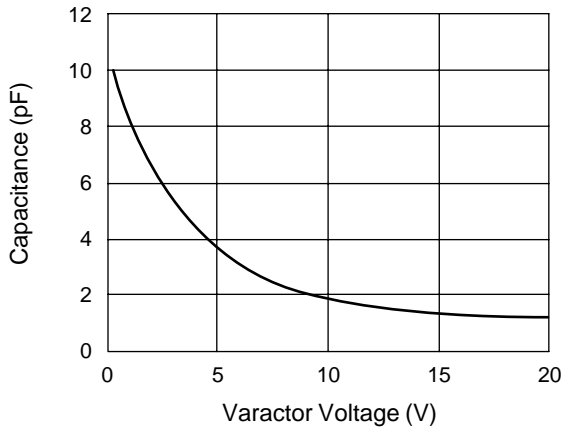

Capacitance vs. Voltage

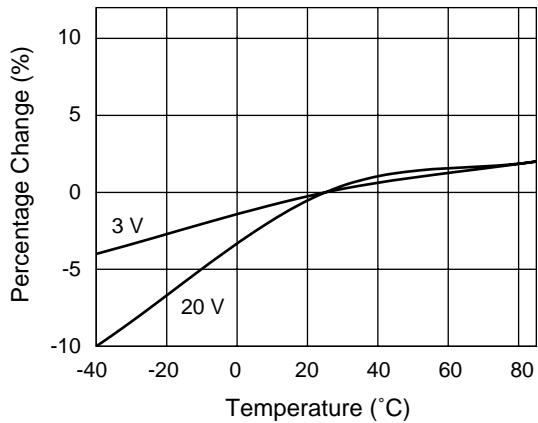

Relative Capacitance Change vs. Temperature

Capacitance vs. Voltage

V_R (V)	C_T (pF)
0.5	10.34
1.0	8.69
2.5	5.98
3.0	5.38
6.0	3.11
10.0	1.92
20.0	1.17

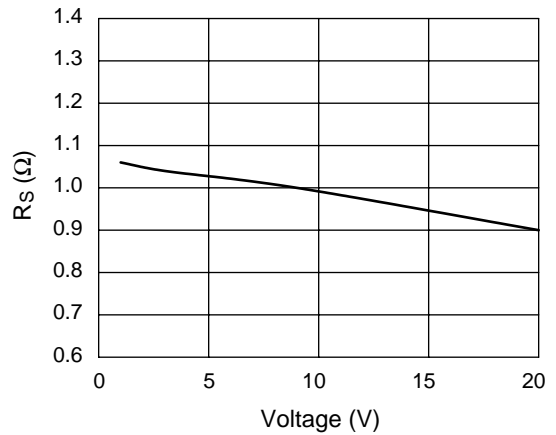

Series Resistance vs. Voltage

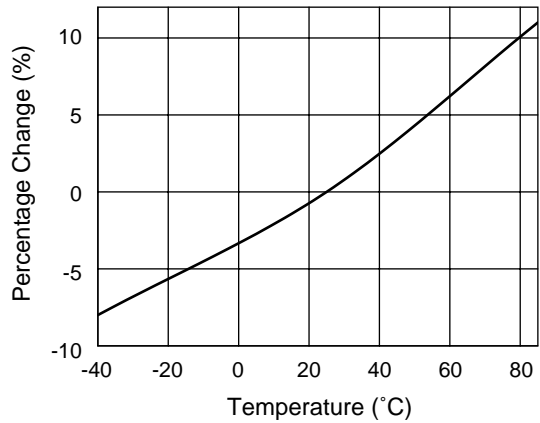

Relative Series Resistance Change vs. Temperature

SOD-323

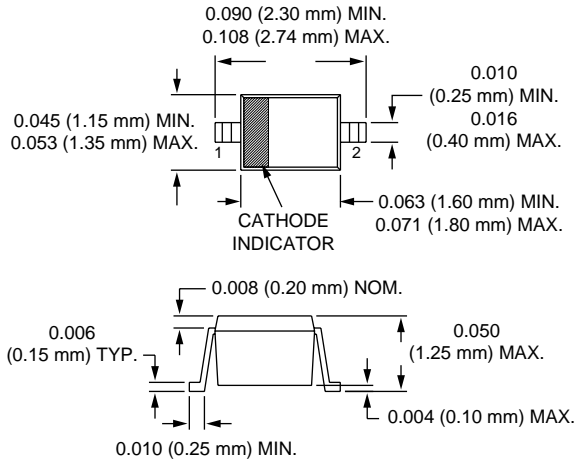

SOT-23

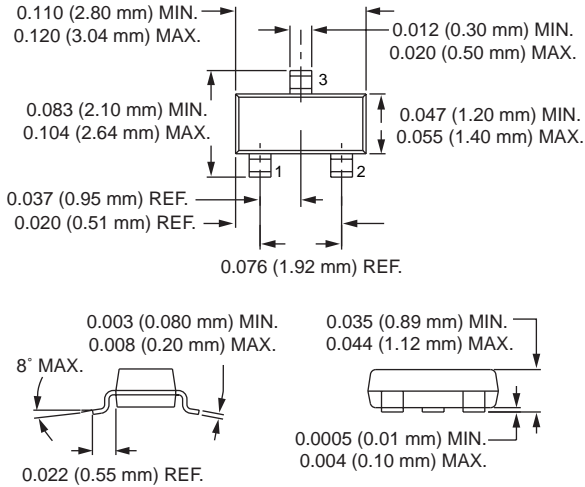

SPICE Model

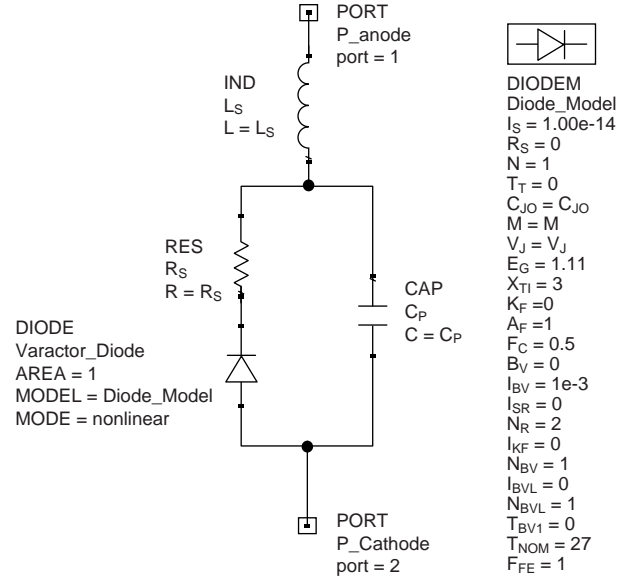

Part Number	C _{J0} (pF)	V _J (V)	M	C _P (pF)	R _S (Ω)	L _S (nH)
SMV1135-011	10.3	8.6	2.9	0.8	1.2	1.5