

# TPD1024S

## Low-Side Power Switch for Motors, Solenoids, and Lamp Drivers

TPD1024S is a monolithic power IC for low-side switches. The IC has a vertical MOS FET output which can be directly driven from a CMOS or TTL logic circuit (e.g. an MPU).

The device offers intelligent self-protection function

### Features

- A monolithic power IC with a new structure combining a control block and a vertical power MOS FET ( $\pi$ -MOS) on a single chip.
- Can directly drive a power load from a CMOS logic.
- Built-in protection against overvoltage, load short circuiting, and thermal shutdown.
- Low on resistance :  $R_{DS(ON)} = 0.5 \Omega(\text{max})$ , (@ $V_{IN} = 5 \text{ V}$ ,  $T_j = 25^\circ\text{C}$ )
- 3-pin power-molded package usable for surface mounting.

### Pin Assignment

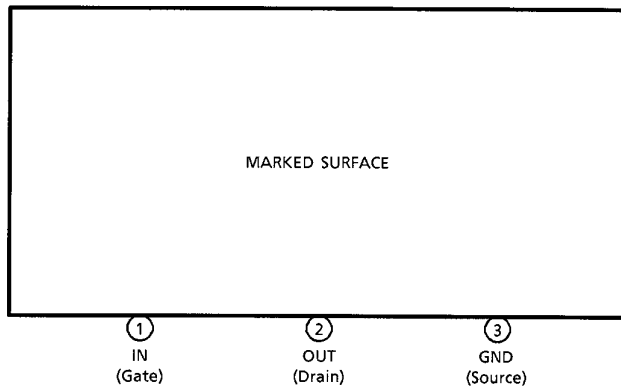

Note: That because of its MOS structure, this product is sensitive to static electricity.

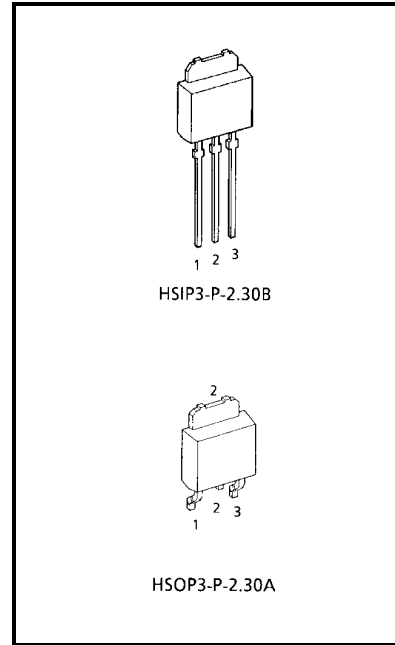

Weight	
HSIP3-P-2.30B	: 0.36 g (typ.)
HSOP3-P-2.30A	: 0.28 g (typ.)

## Block Diagram

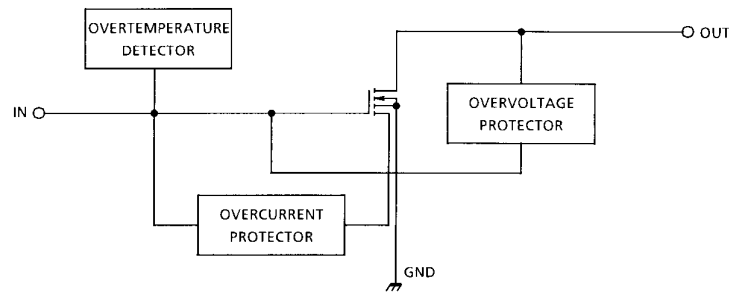

## Pin Description

Pin No.	Symbol	Function
1	IN	Input pin. Input is CMOS-compatible, with pull-down resistor connected. Even if the input is open, output will not accidentally turn on.
2	OUT	Output pin. When current in excess of the typical current (3.5 A (typ.)) flows to the output pin, the current limiter operates to protect the IC.
3	GND	Ground pin.

## Timing Chart

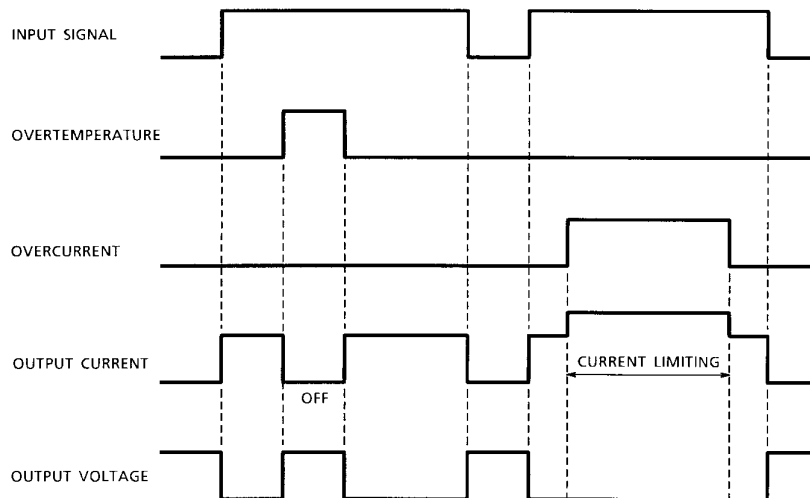

## Maximum Ratings (Ta = 25°C)

Characteristic		Symbol	Rating	Unit
Drain-source voltage		$V_{DS}$ (DC)	40	V
Output current		$I_D$	1.5	A
Input voltage		$V_{GS}$	-0.5 ~ 6	V
Power dissipation	Ta = 25°C	$P_D$	1	W
	Tc = 25°C		10	
Operating temperature		$T_{opr}$	-40 ~ 85	°C
Junction temperature		$T_j$	150	°C
Storage temperature		$T_{stg}$	-55 ~ 150	°C

## Recommendable Condition

Characteristic	Symbol	Test Condition	Min	Typ.	Max	Unit
Input voltage	$V_{IN}$	—	4.5	5	6	V

## Electrical Characteristics (Tj = 25°C)

Characteristic	Symbol	Test Circuit	Test Condition	Min	Typ.	Max	Unit
Drain-source breakdown voltage	$V_{(BR)DSS}$	—	$V_{GS} = 0, I_D = 10 \text{ mA}$	40	—	—	V
Operating supply voltage	$V_{DD}$ (OPR)	—	—	—	—	18	V
Current at output off	$I_{DSS}$ (1)	—	$V_{GS} = 0, V_{DS} = 40 \text{ V}$	—	—	3	mA
	$I_{DSS}$ (2)	—	$V_{GS} = 0, V_{DS} = 24 \text{ V}$	—	—	100	μA
Input threshold voltage	$V_{th}$	—	$V_{DS} = 10 \text{ V}, I_D = 1 \text{ mA}$	0.8	—	2.5	V
Input current	$I_{GSS}$	—	$V_{GS} = 5 \text{ V}$ , at normal operation	—	—	300	μA
On resistance	$R_{DS(ON)}$	—	$V_{GS} = 5 \text{ V}, I_D = 1 \text{ A}$	—	—	0.5	Ω
Thermal shutdown temperature	$T_S$	—	—	—	160	—	°C
Overcurrent protection	$I_S$	—	$V_{DS} = 12 \text{ V}, V_{GS} = 5 \text{ V}$	—	3.5	—	A
Switching time	$t_{ON}$	1	$V_{DS} = 12 \text{ V}, V_{GS} = 5 \text{ V}$ , $R_L = 12 \text{ Ω}$	—	50	—	μs
	$t_{OFF}$			—	10	—	μs
Diode forward voltage Between drain and source	$V_{DSF}$	—	$I_F = 1.5 \text{ A}$	—	0.9	1.8	V
Avalanche energy	$E_A$	—	L = 10 mH, Single pulse	30	—	—	mJ

## Test Circuit 1

Switching Time

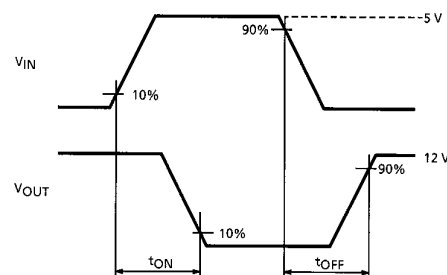
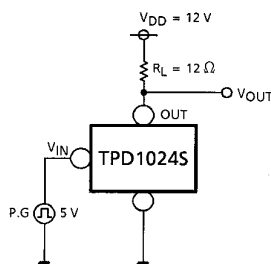

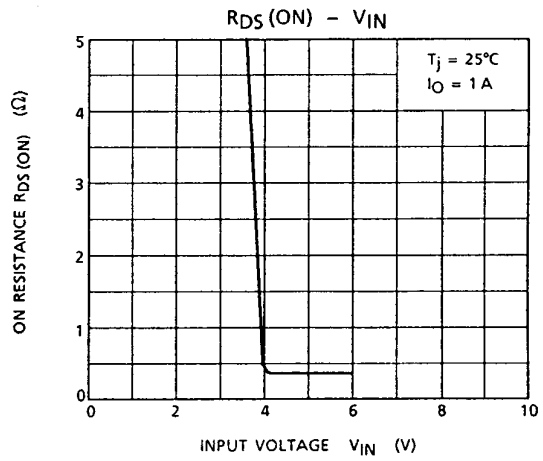
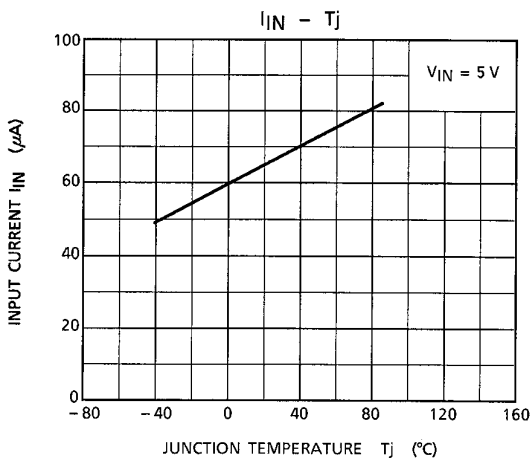
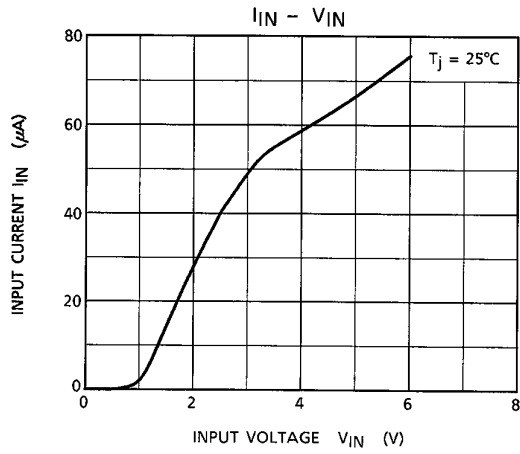
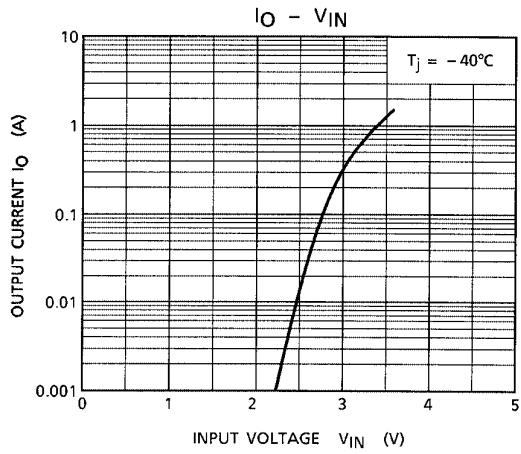
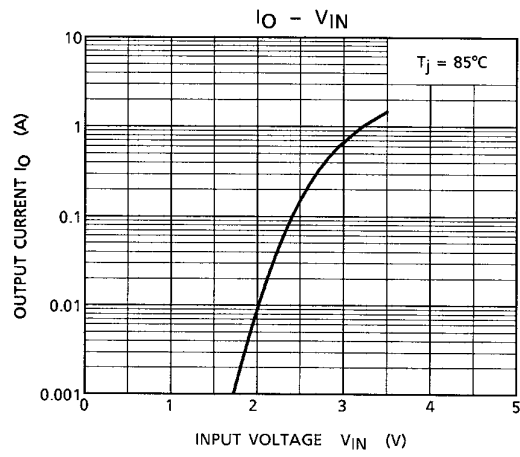
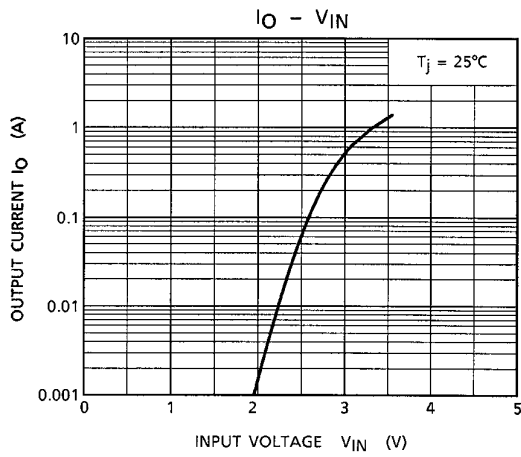

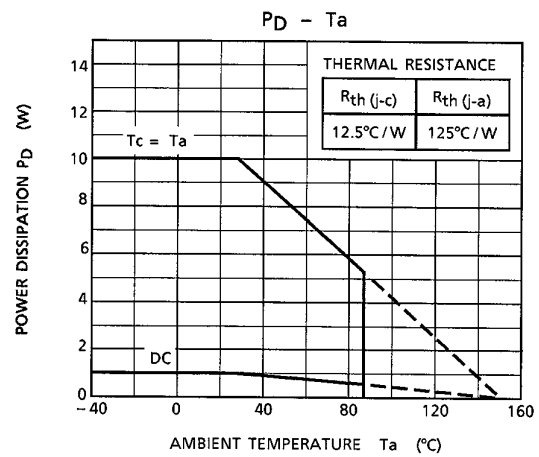
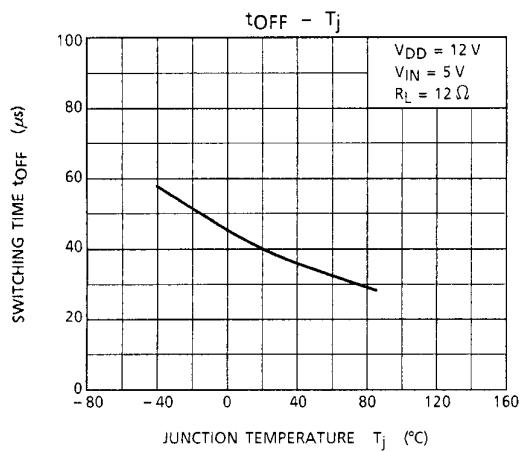
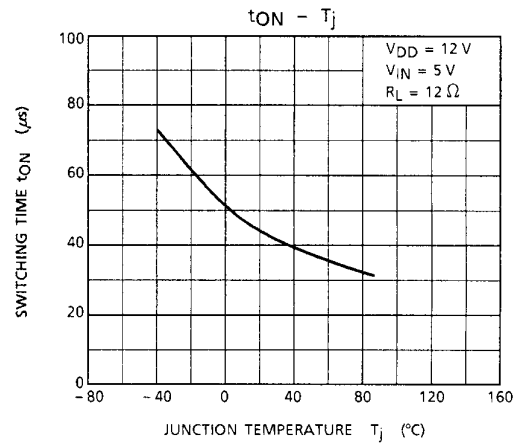
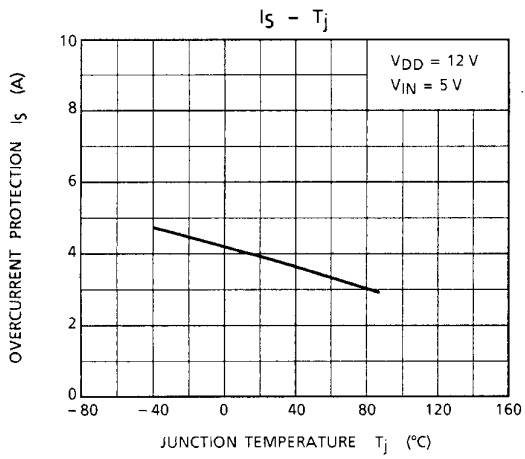
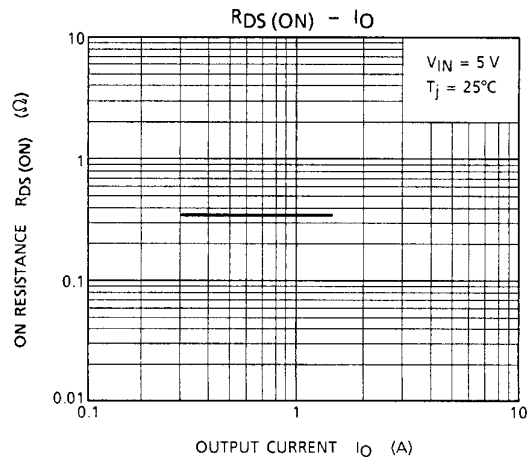
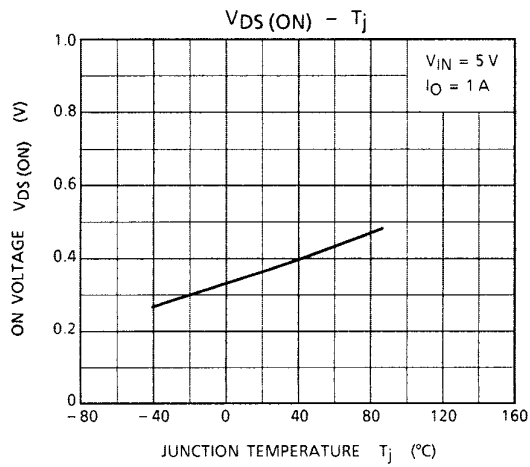

## Package Dimenstions

HSIP3-P-2.30B

Unit : mm

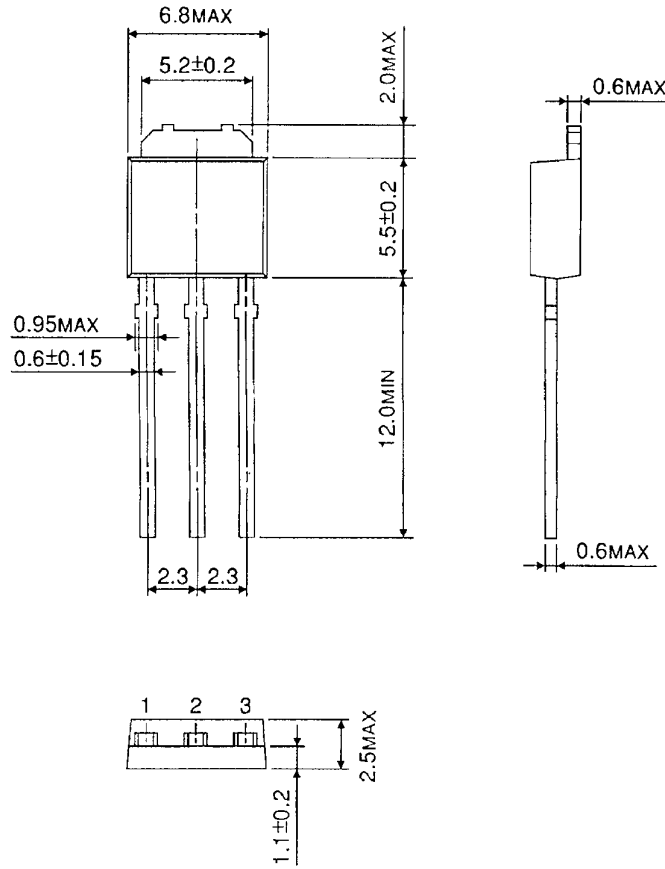

Weight: 0.36 g (typ.)

## Package Dimenstions

HSOP3-P-2.30A

Unit : mm

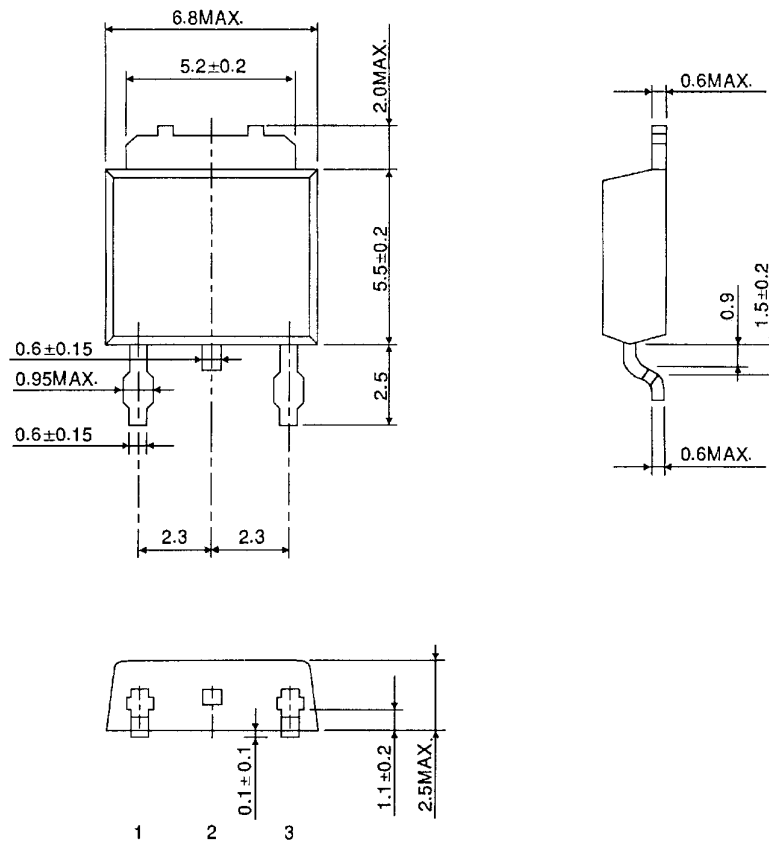

Weight: 0.28 g (typ.)

**RESTRICTIONS ON PRODUCT USE**

000707EBA

- TOSHIBA is continually working to improve the quality and reliability of its products. Nevertheless, semiconductor devices in general can malfunction or fail due to their inherent electrical sensitivity and vulnerability to physical stress. It is the responsibility of the buyer, when utilizing TOSHIBA products, to comply with the standards of safety in making a safe design for the entire system, and to avoid situations in which a malfunction or failure of such TOSHIBA products could cause loss of human life, bodily injury or damage to property.  
In developing your designs, please ensure that TOSHIBA products are used within specified operating ranges as set forth in the most recent TOSHIBA products specifications. Also, please keep in mind the precautions and conditions set forth in the "Handling Guide for Semiconductor Devices," or "TOSHIBA Semiconductor Reliability Handbook" etc..
- The TOSHIBA products listed in this document are intended for usage in general electronics applications (computer, personal equipment, office equipment, measuring equipment, industrial robotics, domestic appliances, etc.). These TOSHIBA products are neither intended nor warranted for usage in equipment that requires extraordinarily high quality and/or reliability or a malfunction or failure of which may cause loss of human life or bodily injury ("Unintended Usage"). Unintended Usage include atomic energy control instruments, airplane or spaceship instruments, transportation instruments, traffic signal instruments, combustion control instruments, medical instruments, all types of safety devices, etc.. Unintended Usage of TOSHIBA products listed in this document shall be made at the customer's own risk.
- The products described in this document are subject to the foreign exchange and foreign trade laws.
- The information contained herein is presented only as a guide for the applications of our products. No responsibility is assumed by TOSHIBA CORPORATION for any infringements of intellectual property or other rights of the third parties which may result from its use. No license is granted by implication or otherwise under any intellectual property or other rights of TOSHIBA CORPORATION or others.
- The information contained herein is subject to change without notice.