

3W Filter-free Class D Audio Power Amplifier

PRELIMINARY DATA

- Operating from $V_{CC}=2.4V$ to $5.5V$
- Standby mode active low
- Output power: $3W$ into 4Ω and $1.75W$ into 8Ω with 10% THD+N max and $5V$ power supply.
- Output power: $2.3W$ @ $5V$ or $0.75W$ @ $3.0V$ into 4Ω with 1% THD+N max.
- Output power: $1.4W$ @ $5V$ or $0.45W$ @ $3.0V$ into 8Ω with 1% THD+N max.
- Adjustable gain via external resistors
- Low current consumption $2mA$ @ $3V$
- Efficiency: 88% typ.
- Signal to noise ratio: 85dB typ.
- PSRR: 63dB typ. @217Hz with 6dB gain
- PWM base frequency: 250kHz
- Low pop & click noise
- Thermal shutdown protection
- Available in flip-chip $9 \times 300\mu m$ in lead free*

Pin Connections (top view)

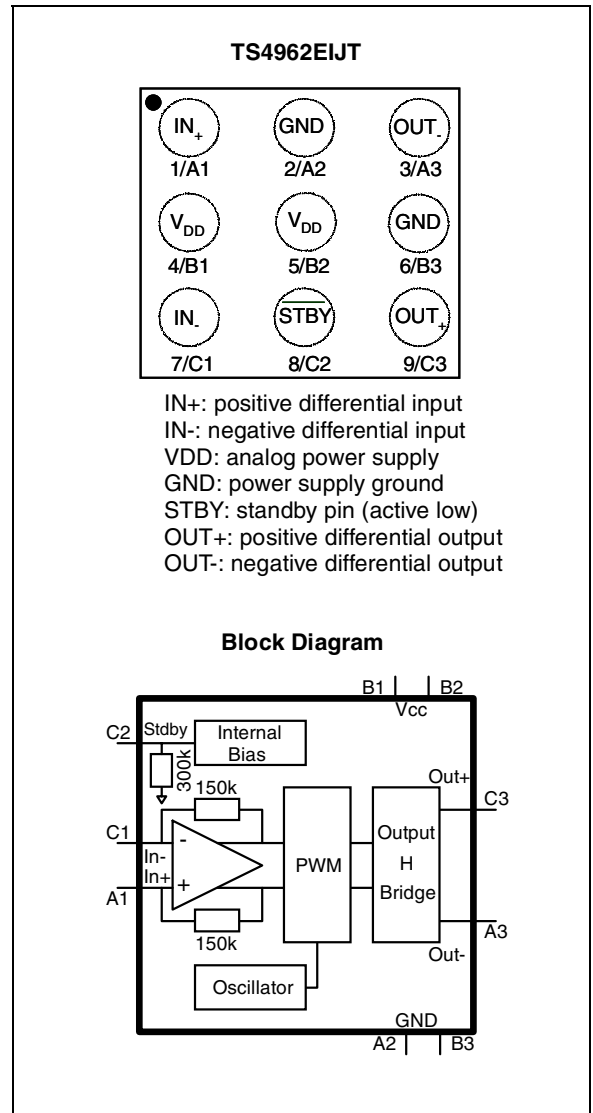

Description

The TS4962 is a differential class-D B.T.L. power amplifier. Able to drive up to $2.3W$ into a 4Ω load and $1.4W$ into a 8Ω load at $5V$. It achieves outstanding efficiency (88%typ.) compared to classical AB-class audio amps.

Gain of the device can be controlled via two external gain setting resistors. POP & CLICK reduction circuitry provides low on/off switch noise while allowing the device to start within 5ms. A standby function (active low) allows to lower the current consumption to $10nA$ typ.

Applications

- Cellular Phone
- PDA
- Notebook PC

Order Codes

Part Number	Temperature Range	Package	Packaging	Marking
TS4962IJT	-40, +85°C	Flip-Chip	Tape & Reel	A62
TS4962EIJT	-40, +85°C	Lead-Free Flip-Chip		A62
TS4962EKIJT	-40, +85°C	Lead Free + Back Coating		A62

1 Absolute Maximum Ratings

Table 1. Key parameters and their absolute maximum ratings

Symbol	Parameter	Value	Unit
V_{CC}	Supply voltage ¹	6	V
V_i	Input Voltage ²	G_{ND} to V_{CC}	V
T_{oper}	Operating Free Air Temperature Range	-40 to + 85	°C
T_{stg}	Storage Temperature	-65 to +150	°C
T_j	Maximum Junction Temperature	150	°C
R_{thja}	Thermal Resistance Junction to Ambient ³	200	°C/W
P_d	Power Dissipation	Internally Limited ⁴	
ESD	Human Body Model	2	kV
ESD	Machine Model	200	V
Latch-up	Latch-up Immunity	200	mA
V_{STB}	Standby pin voltage maximum voltage ⁵	G_{ND} to V_{CC}	V
	Lead Temperature (soldering, 10sec)	260	°C

- 1) All voltages values are measured with respect to the ground pin.
- 2) The magnitude of input signal must never exceed $V_{CC} + 0.3V / G_{ND} - 0.3V$
- 3) Device is protected in case of over temperature by a thermal shutdown active @ 150°C.
- 4) Exceeding the power derating curves during a long period, involves abnormal operating condition.
- 5) The magnitude of standby signal must never exceed $V_{CC} + 0.3V / G_{ND} - 0.3V$

Table 2. Operating Conditions

Symbol	Parameter	Value	Unit
V_{CC}	Supply Voltage ¹	2.4 to 5.5	V
V_{IC}	Common Mode Input Voltage Range ²	0.5 to $V_{CC}-0.8$	V
V_{STB}	Standby Voltage Input : ³ Device ON Device OFF	$1.4 \leq V_{STB} \leq V_{CC}$ $G_{ND} \leq V_{STB} \leq 0.4$ ⁴	V
RL	Load Resistor	≥ 4	Ω
R_{thja}	Thermal Resistance Junction to Ambient ⁵	90	°C/W

- 1) For V_{CC} from 2.4V to 2.5V, the operating temperature range is reduced to $0^\circ\text{C} \leq T_{amb} \leq 70^\circ\text{C}$
- 2) For V_{CC} from 2.4V to 2.5V, the common mode input range must be set at $V_{CC}/2$.
- 3) Without any signal on V_{STB} , the device will be in standby
- 4) Minimum current consumption shall be obtained when $V_{STB} = G_{ND}$.
- 5) With heat sink surface = 125mm².

2 Application Component Information

Component	Functional Description
Cs	Bypass supply capacitor. To install as close as possible of the TS4962 to minimize high frequency ripple. A 100nF ceramic capacitor should be add to enhance the power supply filtering in high frequency.
Rin	Input resistor to program the TS4962 differential gain (Gain = $300k\Omega/R_{in}$ with Rin in k Ω)
Input Capacitor	Thanks to common mode feedback, these input capacitors are optional. However, we can add them to form with Rin a 1st order high pass filter with -3dB cut-off frequency = $1/(2*\pi*R_{in}*C_{in})$

Figure 1. Typical application

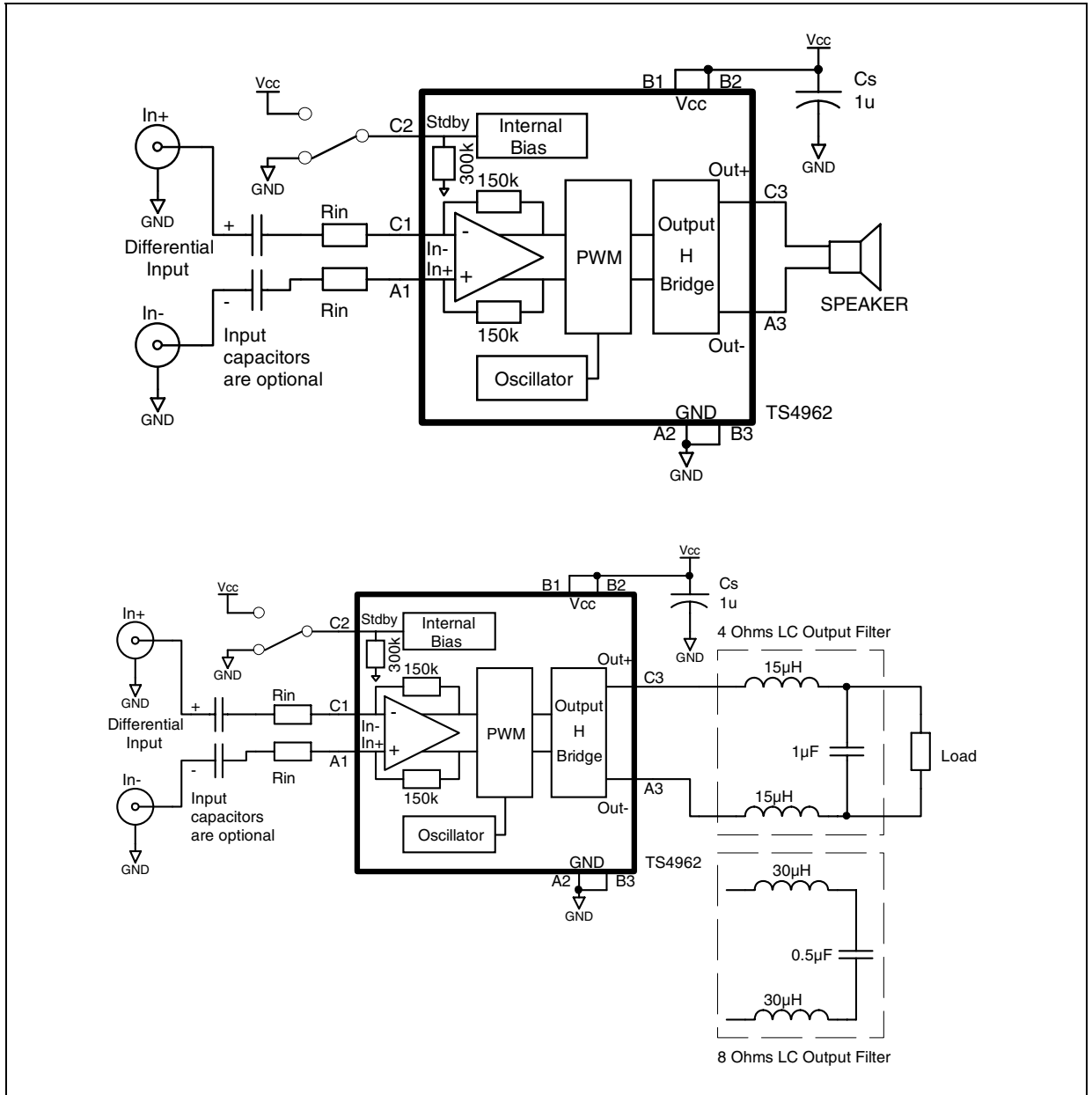

3 Electrical Characteristics

Table 3. $V_{CC} = +5V$, $GND = 0V$, $V_{ICM} = 2.5V$, $T_{amb} = 25^{\circ}C$ (unless otherwise specified)

Symbol	Parameter	Min.	Typ.	Max.	Unit
I_{CC}	Supply Current No input signal, no load		2.3	3.3	mA
$I_{STANDBY}$	Standby Current ¹ No input signal, $V_{STBY} = GND$		10	1000	nA
V_{OO}	Output Offset Voltage No input signal, $R_L = 8\Omega$		3	25	mV
P_O	Output Power, $G=6dB$ THD = 1% Max, $f = 1kHz$, $R_L = 4\Omega$ THD = 10% Max, $f = 1kHz$, $R_L = 4\Omega$ THD = 1% Max, $f = 1kHz$, $R_L = 8\Omega$ THD = 10% Max, $f = 1kHz$, $R_L = 8\Omega$		2.3 3 1.4 1.75		W
THD + N	Total Harmonic Distortion + Noise $P_O = 900\text{ mW}_{RMS}$, $G = 6dB$, $20Hz < f < 20kHz$, $R_L = 8\Omega + 15\mu H$, $BW < 30kHz$ $P_O = 1W_{RMS}$, $G = 6dB$, $f = 1kHz$, $R_L = 8\Omega + 15\mu H$, $BW < 30kHz$		1 0.4		%
Efficiency	Efficiency $P_O = 2\text{ W}_{RMS}$, $R_L = 4\Omega + \geq 15\mu H$ $P_O = 1.2\text{ W}_{RMS}$, $R_L = 8\Omega + \geq 15\mu H$		78 88		%
PSRR	Power Supply Rejection Ratio with inputs grounded ² $f = 217Hz$, $R_L = 8\Omega$, $G=6dB$, $V_{ripple} = 200mV_{pp}$		63		dB
CMRR	Common Mode Rejection Ratio, $f = 217Hz$, $R_L = 8\Omega$, $G = 6dB$, $\Delta V_{ic} = 200mV_{pp}$		57		dB
Gain	Gain value (R_{in} in $k\Omega$)	$\frac{273k\Omega}{R_{in}}$	$\frac{300k\Omega}{R_{in}}$	$\frac{327k\Omega}{R_{in}}$	V/V
R_{STDBY}	Internal Resistance From Standby to GND	273	300	327	$k\Omega$
F_{PWM}	Pulse Width Modulator Base Frequency	180	250	320	kHz
SNR	Signal to Noise ratio (A Weighting), $P_O = 1.2W$, $R_L = 8\Omega$		85		dB
T_{WU}	Wake-up time		5	10	ms
T_{STB}	Standby time		5	10	ms
V_N	Output Voltage Noise $f = 20Hz$ to $20kHz$, $G = 6dB$ Unweighted $R_L = 4\Omega$ A weighted $R_L = 4\Omega$ Unweighted $R_L = 8\Omega$ A weighted $R_L = 8\Omega$ Unweighted $R_L = 4\Omega + 15\mu H$ A weighted $R_L = 4\Omega + 15\mu H$ Unweighted $R_L = 4\Omega + 30\mu H$ A weighted $R_L = 4\Omega + 30\mu H$ Unweighted $R_L = 8\Omega + 30\mu H$ A weighted $R_L = 8\Omega + 30\mu H$ Unweighted $R_L = 4\Omega + \text{Filter}$ A weighted $R_L = 4\Omega + \text{Filter}$ Unweighted $R_L = 4\Omega + \text{Filter}$ A weighted $R_L = 4\Omega + \text{Filter}$		85 60 86 62 83 60 88 64 78 57 87 65 82 59 90 66		μV_{RMS}

1) Standby mode is active when V_{stdby} is tied to GND.

2) Dynamic measurements - $20 \cdot \log(\text{rms}(V_{out})/\text{rms}(V_{ripple}))$. V_{ripple} is the surimposed sinus signal to V_{CC} @ $f = 217Hz$.

Table 4. $V_{CC} = +4.2V$, $GND = 0V$, $V_{ICM} = 2.1V$, $T_{amb} = 25^{\circ}C$ (unless otherwise specified) ¹

Symbol	Parameter	Min.	Typ.	Max.	Unit
I_{CC}	Supply Current No input signal, no load		2.1	3	mA
$I_{STANDBY}$	Standby Current ² No input signal, $V_{STBY} = GND$		10	1000	nA
V_{OO}	Output Offset Voltage No input signal, $R_L = 8\Omega$		3	25	mV
P_O	Output Power, $G=6dB$ THD = 1% Max, $f = 1kHz$, $R_L = 4\Omega$ THD = 10% Max, $f = 1kHz$, $R_L = 4\Omega$ THD = 1% Max, $f = 1kHz$, $R_L = 8\Omega$ THD = 10% Max, $f = 1kHz$, $R_L = 8\Omega$		1.6 2 0.95 1.2		W
THD + N	Total Harmonic Distortion + Noise $P_o = 600\text{ mW}_{RMS}$, $G = 6dB$, $20Hz < f < 20kHz$, $R_L = 8\Omega + 15\mu H$, $BW < 30kHz$ $P_o = 700\text{ mW}_{RMS}$, $G = 6dB$, $f = 1kHz$, $R_L = 8\Omega + 15\mu H$, $BW < 30kHz$		1 0.35		%
Efficiency	Efficiency $P_o = 1.45\text{ W}_{RMS}$, $R_L = 4\Omega + \geq 15\mu H$ $P_o = 0.9\text{ W}_{RMS}$, $R_L = 8\Omega + \geq 15\mu H$		78 88		%
PSRR	Power Supply Rejection Ratio with inputs grounded ³ $f = 217Hz$, $R_L = 8\Omega$, $G=6dB$, $V_{ripple} = 200mV_{pp}$		63		dB
CMRR	Common Mode Rejection Ratio $f = 217Hz$, $R_L = 8\Omega$, $G = 6dB$, $\Delta V_{ic} = 200mV_{pp}$		57		dB
Gain	Gain value (R_{in} in $k\Omega$)	$\frac{273k\Omega}{R_{in}}$	$\frac{300k\Omega}{R_{in}}$	$\frac{327k\Omega}{R_{in}}$	V/V
R_{STDBY}	Internal Resistance From Standby to GND	273	300	327	$k\Omega$
F_{PWM}	Pulse Width Modulator Base Frequency	180	250	320	kHz
SNR	Signal to Noise ratio (A Weighting), $P_o = 0.9W$, $R_L = 8\Omega$		85		dB
T_{WU}	Wake-up time		5	10	ms
T_{STB}	Standby time		5	10	ms
V_N	Output Voltage Noise $f = 20Hz$ to $20kHz$, $G = 6dB$ Unweighted $R_L = 4\Omega$ A weighted $R_L = 4\Omega$ Unweighted $R_L = 8\Omega$ A weighted $R_L = 8\Omega$ Unweighted $R_L = 4\Omega + 15\mu H$ A weighted $R_L = 4\Omega + 15\mu H$ Unweighted $R_L = 4\Omega + 30\mu H$ A weighted $R_L = 4\Omega + 30\mu H$ Unweighted $R_L = 8\Omega + 30\mu H$ A weighted $R_L = 8\Omega + 30\mu H$ Unweighted $R_L = 4\Omega + \text{Filter}$ A weighted $R_L = 4\Omega + \text{Filter}$ Unweighted $R_L = 4\Omega + \text{Filter}$ A weighted $R_L = 4\Omega + \text{Filter}$		85 60 86 62 83 60 88 64 78 57 87 65 82 59 90 66		μV_{RMS}

1) All electrical values are guaranteed with correlation measurements at 2.5V and 5V.

2) Standby mode is activated when V_{stdby} is tied to GND.

3) Dynamic measurements - $20 \cdot \log(\text{rms}(V_{out})/\text{rms}(V_{ripple}))$. Ripple is the surimposed sinus signal to V_{cc} @ $f = 217Hz$.

Table 5. $V_{CC} = +3.6V$, $GND = 0V$, $V_{ICM} = 1.8V$, $T_{amb} = 25^{\circ}C$ (unless otherwise specified) ¹

Symbol	Parameter	Min.	Typ.	Max.	Unit
I_{CC}	Supply Current No input signal, no load		2	2.8	mA
$I_{STANDBY}$	Standby Current ² No input signal, $V_{STBY} = GND$		10	1000	nA
V_{OO}	Output Offset Voltage No input signal, $R_L = 8\Omega$		3	25	mV
P_O	Output Power, $G=6dB$ THD = 1% Max, $f = 1kHz$, $R_L = 4\Omega$ THD = 10% Max, $f = 1kHz$, $R_L = 4\Omega$ THD = 1% Max, $f = 1kHz$, $R_L = 8\Omega$ THD = 10% Max, $f = 1kHz$, $R_L = 8\Omega$		1.15 1.51 0.7 0.9		W
THD + N	Total Harmonic Distortion + Noise $P_o = 500\text{ mW}_{RMS}$, $G = 6dB$, $20Hz < f < 20kHz$, $R_L = 8\Omega + 15\mu H$, $BW < 30kHz$ $P_o = 500\text{ mW}_{RMS}$, $G = 6dB$, $f = 1kHz$, $R_L = 8\Omega + 15\mu H$, $BW < 30kHz$		1 0.27		%
Efficiency	Efficiency $P_o = 1\text{ W}_{RMS}$, $R_L = 4\Omega + \geq 15\mu H$ $P_o = 0.65\text{ W}_{RMS}$, $R_L = 8\Omega + \geq 15\mu H$		78 88		%
PSRR	Power Supply Rejection Ratio with inputs grounded ³ $f = 217Hz$, $R_L = 8\Omega$, $G=6dB$, $V_{ripple} = 200\text{mV}_{pp}$		62		dB
CMRR	Common Mode Rejection Ratio $f = 217Hz$, $R_L = 8\Omega$, $G = 6dB$, $\Delta V_{ic} = 200\text{mV}_{pp}$		56		dB
Gain	Gain value (R_{in} in $k\Omega$)	$\frac{273k\Omega}{R_{in}}$	$\frac{300k\Omega}{R_{in}}$	$\frac{327k\Omega}{R_{in}}$	V/V
R_{STDBY}	Internal Resistance From Standby to GND	273	300	327	$k\Omega$
F_{PWM}	Pulse Width Modulator Base Frequency	180	250	320	kHz
SNR	Signal to Noise ratio (A Weighting), $P_o = 0.6W$, $R_L = 8\Omega$		83		dB
T_{WU}	Wake-up time		5	10	ms
T_{STB}	Standby time		5	10	ms
V_N	Output Voltage Noise $f = 20Hz$ to $20kHz$, $G = 6dB$ Unweighted $R_L = 4\Omega$ A weighted $R_L = 4\Omega$ Unweighted $R_L = 8\Omega$ A weighted $R_L = 8\Omega$ Unweighted $R_L = 4\Omega + 15\mu H$ A weighted $R_L = 4\Omega + 15\mu H$ Unweighted $R_L = 4\Omega + 30\mu H$ A weighted $R_L = 4\Omega + 30\mu H$ Unweighted $R_L = 8\Omega + 30\mu H$ A weighted $R_L = 8\Omega + 30\mu H$ Unweighted $R_L = 4\Omega + \text{Filter}$ A weighted $R_L = 4\Omega + \text{Filter}$ Unweighted $R_L = 4\Omega + \text{Filter}$ A weighted $R_L = 4\Omega + \text{Filter}$		83 57 83 61 81 58 87 62 77 56 85 63 80 57 85 61		μV_{RMS}

1) All electrical values are guaranteed with correlation measurements at 2.5V and 5V.

2) Standby mode is activated when V_{stdby} is tied to GND.

3) Dynamic measurements - $20 \cdot \log(\text{rms}(V_{out})/\text{rms}(V_{ripple}))$. V_{ripple} is the surimposed sinus signal to V_{cc} @ $f = 217Hz$.

Table 6. $V_{CC} = +3.0V$, $GND = 0V$, $V_{ICM} = 1.5V$, $T_{amb} = 25^{\circ}C$ (unless otherwise specified) ¹

Symbol	Parameter	Min.	Typ.	Max.	Unit
I_{CC}	Supply Current No input signal, no load		1.9	2.7	mA
$I_{STANDBY}$	Standby Current ² No input signal, $V_{STBY} = GND$		10	1000	nA
V_{OO}	Output Offset Voltage No input signal, $R_L = 8\Omega$		3	25	mV
P_O	Output Power, $G=6dB$ THD = 1% Max, $f = 1kHz$, $R_L = 4\Omega$ THD = 10% Max, $f = 1kHz$, $R_L = 4\Omega$ THD = 1% Max, $f = 1kHz$, $R_L = 8\Omega$ THD = 10% Max, $f = 1kHz$, $R_L = 8\Omega$		0.75 1 0.5 0.6		W
THD + N	Total Harmonic Distortion + Noise $P_o = 350 mW_{RMS}$, $G = 6dB$, $20Hz < f < 20kHz$, $R_L = 8\Omega + 15\mu H$, $BW < 30kHz$ $P_o = 350mW_{RMS}$, $G = 6dB$, $f = 1kHz$, $R_L = 8\Omega + 15\mu H$, $BW < 30kHz$		1 0.21		%
Efficiency	Efficiency $P_o = 0.7 W_{RMS}$, $R_L = 4\Omega + \geq 15\mu H$ $P_o = 0.45 W_{RMS}$, $R_L = 8\Omega + \geq 15\mu H$		78 88		%
PSRR	Power Supply Rejection Ratio with inputs grounded ³ $f = 217Hz$, $R_L = 8\Omega$, $G=6dB$, $V_{ripple} = 200mV_{pp}$		60		dB
CMRR	Common Mode Rejection Ratio, $f = 217Hz$, $R_L = 8\Omega$, $G = 6dB$, $\Delta V_{ic} = 200mV_{pp}$		54		dB
Gain	Gain value (R_{in} in $k\Omega$)	$\frac{273k\Omega}{R_{in}}$	$\frac{300k\Omega}{R_{in}}$	$\frac{327k\Omega}{R_{in}}$	V/V
R_{STDBY}	Internal Resistance From Standby to GND	273	300	327	$k\Omega$
F_{PWM}	Pulse Width Modulator Base Frequency	180	250	320	kHz
SNR	Signal to Noise ratio (A Weighting), $P_o = 0.4W$, $R_L = 8\Omega$		82		dB
T_{WU}	Wake-up time		5	10	ms
T_{STB}	Standby time		5	10	ms
V_N	Output Voltage Noise $f = 20Hz$ to $20kHz$, $G = 6dB$ Unweighted $R_L = 4\Omega$ A weighted $R_L = 4\Omega$ Unweighted $R_L = 8\Omega$ A weighted $R_L = 8\Omega$ Unweighted $R_L = 4\Omega + 15\mu H$ A weighted $R_L = 4\Omega + 15\mu H$ Unweighted $R_L = 4\Omega + 30\mu H$ A weighted $R_L = 4\Omega + 30\mu H$ Unweighted $R_L = 8\Omega + 30\mu H$ A weighted $R_L = 8\Omega + 30\mu H$ Unweighted $R_L = 4\Omega + Filter$ A weighted $R_L = 4\Omega + Filter$ Unweighted $R_L = 4\Omega + Filter$ A weighted $R_L = 4\Omega + Filter$		83 57 83 61 81 58 87 62 77 56 85 63 80 57 85 61		μV_{RMS}

1) All electrical values are guaranteed with correlation measurements at 2.5V and 5V.

2) Standby mode is activated when V_{stb} is tied to GND.

3) Dynamic measurements - $20 \cdot \log(\text{rms}(V_{out})/\text{rms}(V_{ripple}))$. Vripple is the surimposed sinus signal to V_{cc} @ $f = 217Hz$.

Table 7. $V_{CC} = +2.5V$, $GND = 0V$, $V_{ICM} = 1.25V$, $T_{amb} = 25^{\circ}C$ (unless otherwise specified)

Symbol	Parameter	Min.	Typ.	Max.	Unit
I_{CC}	Supply Current No input signal, no load		1.7	2.4	mA
$I_{STANDBY}$	Standby Current ¹ No input signal, $V_{STBY} = GND$		10	1000	nA
V_{OO}	Output Offset Voltage No input signal, $R_L = 8\Omega$		3	25	mV
P_o	Output Power, $G=6dB$ THD = 1% Max, $f = 1kHz$, $R_L = 4\Omega$ THD = 10% Max, $f = 1kHz$, $R_L = 4\Omega$ THD = 1% Max, $f = 1kHz$, $R_L = 8\Omega$ THD = 10% Max, $f = 1kHz$, $R_L = 8\Omega$		0.52 0.71 0.33 0.42		W
THD + N	Total Harmonic Distortion + Noise $P_o = 200\text{ mW}_{RMS}$, $G = 6dB$, $20Hz < f < 20kHz$, $R_L = 8\Omega + 15\mu H$, $BW < 30kHz$ $P_o = 200\text{ mW}_{RMS}$, $G = 6dB$, $f = 1kHz$, $R_L = 8\Omega + 15\mu H$, $BW < 30kHz$		1 0.19		%
Efficiency	Efficiency $P_o = 0.47\text{ W}_{RMS}$, $R_L = 4\Omega + \geq 15\mu H$ $P_o = 0.3\text{ W}_{RMS}$, $R_L = 8\Omega + \geq 15\mu H$		78 88		%
PSRR	Power Supply Rejection Ratio with inputs grounded ² $f = 217Hz$, $R_L = 8\Omega$, $G=6dB$, $V_{ripple} = 200\text{mV}_{pp}$		60		dB
CMRR	Common Mode Rejection Ratio $f = 217Hz$, $R_L = 8\Omega$, $G = 6dB$, $\Delta V_{ic} = 200\text{mV}_{pp}$		54		dB
Gain	Gain value (R_{in} in $k\Omega$)	$\frac{273k\Omega}{R_{in}}$	$\frac{300k\Omega}{R_{in}}$	$\frac{327k\Omega}{R_{in}}$	V/V
R_{STDBY}	Internal Resistance From Standby to GND	273	300	327	$k\Omega$
F_{PWM}	Pulse Width Modulator Base Frequency	180	250	320	kHz
SNR	Signal to Noise ratio (A Weighting), $P_o = 0.4W$, $R_L = 8\Omega$		80		dB
T_{WU}	Wake-up time		5	10	ms
T_{STB}	Standby time		5	10	ms
V_N	Output Voltage Noise $f = 20Hz$ to $20kHz$, $G = 6dB$ Unweighted $R_L = 4\Omega$ A weighted $R_L = 4\Omega$ Unweighted $R_L = 8\Omega$ A weighted $R_L = 8\Omega$ Unweighted $R_L = 4\Omega + 15\mu H$ A weighted $R_L = 4\Omega + 15\mu H$ Unweighted $R_L = 4\Omega + 30\mu H$ A weighted $R_L = 4\Omega + 30\mu H$ Unweighted $R_L = 8\Omega + 30\mu H$ A weighted $R_L = 8\Omega + 30\mu H$ Unweighted $R_L = 4\Omega + \text{Filter}$ A weighted $R_L = 4\Omega + \text{Filter}$ Unweighted $R_L = 4\Omega + \text{Filter}$ A weighted $R_L = 4\Omega + \text{Filter}$		85 60 86 62 76 56 82 60 67 53 78 57 74 54 78 59		μV_{RMS}

1) Standby mode is activated when V_{stdby} is tied to GND.

2) Dynamic measurements - $20 \cdot \log(\text{rms}(V_{out})/\text{rms}(V_{ripple}))$. Ripple is the surimposed sinus signal to V_{cc} @ $f = 217Hz$.

Table 8. $V_{CC} = +2.4V^1$, $GND = 0V$, $V_{ICM} = 1.2V$, $T_{amb} = 25^\circ C$ (unless otherwise specified)

Symbol	Parameter	Min.	Typ.	Max.	Unit
I_{CC}	Supply Current No input signal, no load		1.7		mA
$I_{STANDBY}$	Standby Current ² No input signal, $V_{STBY} = GND$		10		nA
V_{OO}	Output Offset Voltage No input signal, $R_L = 8\Omega$		3		mV
P_o	Output Power, $G=6dB$ THD = 1% Max, $f = 1kHz$, $R_L = 4\Omega$ THD = 10% Max, $f = 1kHz$, $R_L = 4\Omega$ THD = 1% Max, $f = 1kHz$, $R_L = 8\Omega$ THD = 10% Max, $f = 1kHz$, $R_L = 8\Omega$		0.48 0.65 0.3 0.38		W
THD + N	Total Harmonic Distortion + Noise $P_o = 200 mW_{RMS}$, $G = 6dB$, $20Hz < f < 20kHz$, $R_L = 8\Omega + 15\mu H$, $BW < 30kHz$		1		%
Efficiency	Efficiency $P_o = 0.38 W_{RMS}$, $R_L = 4\Omega + \geq 15\mu H$ $P_o = 0.25 W_{RMS}$, $R_L = 8\Omega + \geq 15\mu H$		77 86		%
CMRR	Common Mode Rejection Ratio $f = 217Hz$, $R_L = 8\Omega$, $G = 6dB$, $\Delta V_{ic} = 200mV_{pp}$		54		dB
Gain	Gain value (R_{in} in $k\Omega$)	$\frac{273k\Omega}{R_{in}}$	$\frac{300k\Omega}{R_{in}}$	$\frac{327k\Omega}{R_{in}}$	V/V
R_{STDBY}	Internal Resistance From Standby to GND	273	300	327	$k\Omega$
F_{PWM}	Pulse Width Modulator Base Frequency		250		kHz
SNR	Signal to Noise ratio (A Weighting), $P_o = 0.25W$, $R_L = 8\Omega$		80		dB
T_{WU}	Wake-up time		5		ms
T_{STB}	Standby time		5		ms
V_N	Output Voltage Noise $f = 20Hz$ to $20kHz$, $G = 6dB$ Unweighted $R_L = 4\Omega$ A weighted $R_L = 4\Omega$ Unweighted $R_L = 8\Omega$ A weighted $R_L = 8\Omega$ Unweighted $R_L = 4\Omega + 15\mu H$ A weighted $R_L = 4\Omega + 15\mu H$ Unweighted $R_L = 4\Omega + 30\mu H$ A weighted $R_L = 4\Omega + 30\mu H$ Unweighted $R_L = 8\Omega + 30\mu H$ A weighted $R_L = 8\Omega + 30\mu H$ Unweighted $R_L = 4\Omega + Filter$ A weighted $R_L = 4\Omega + Filter$ Unweighted $R_L = 4\Omega + Filter$ A weighted $R_L = 4\Omega + Filter$		85 60 86 62 76 56 82 60 67 53 78 57 74 54 78 59		μV_{RMS}

1) Parameters guaranteed by evaluation and design, not by test.

2) Standby mode is activated when V_{stdby} is tied to GND.

Note: In the graphs that follow, the following abbreviations are used:
 RL + 15 μ H or 30 μ H = pure resistor+ very low series resistance inductor
 Filter = LC output filter (1 μ F+30 μ H for 4 Ω and 0.5 μ F+60 μ H for 8 Ω)
 All measurements done with Cs1=1 μ F and Cs2=100nF except for PSRR where Cs1 is removed

Figure 2. Test diagram for measurements

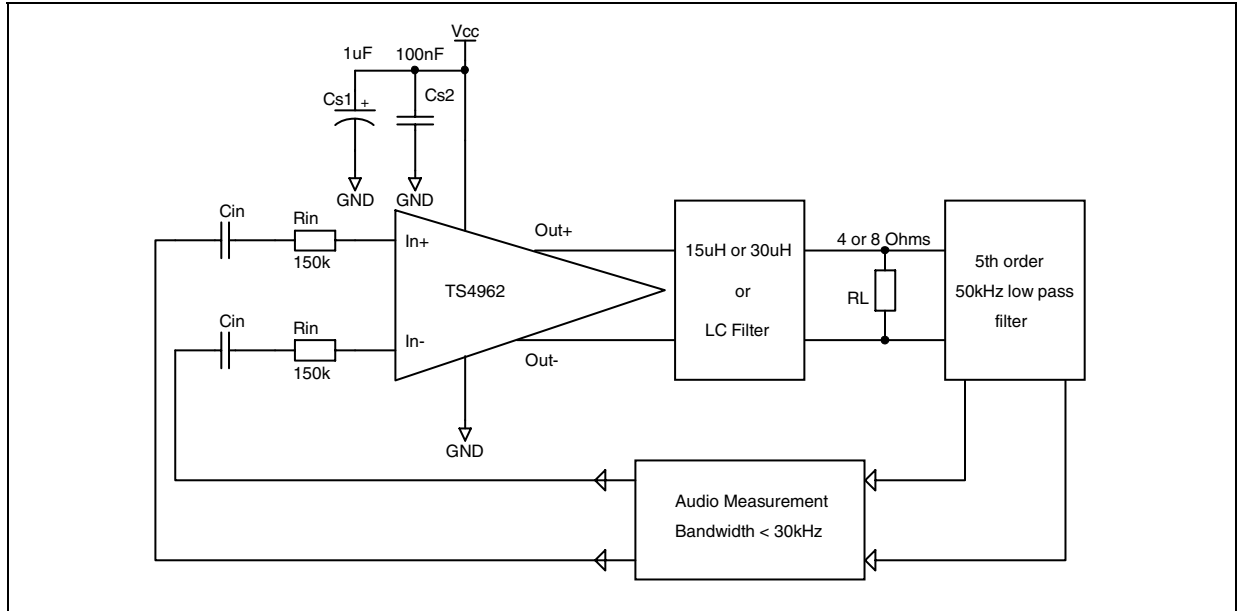

Figure 3. Test diagram for PSRR measurements

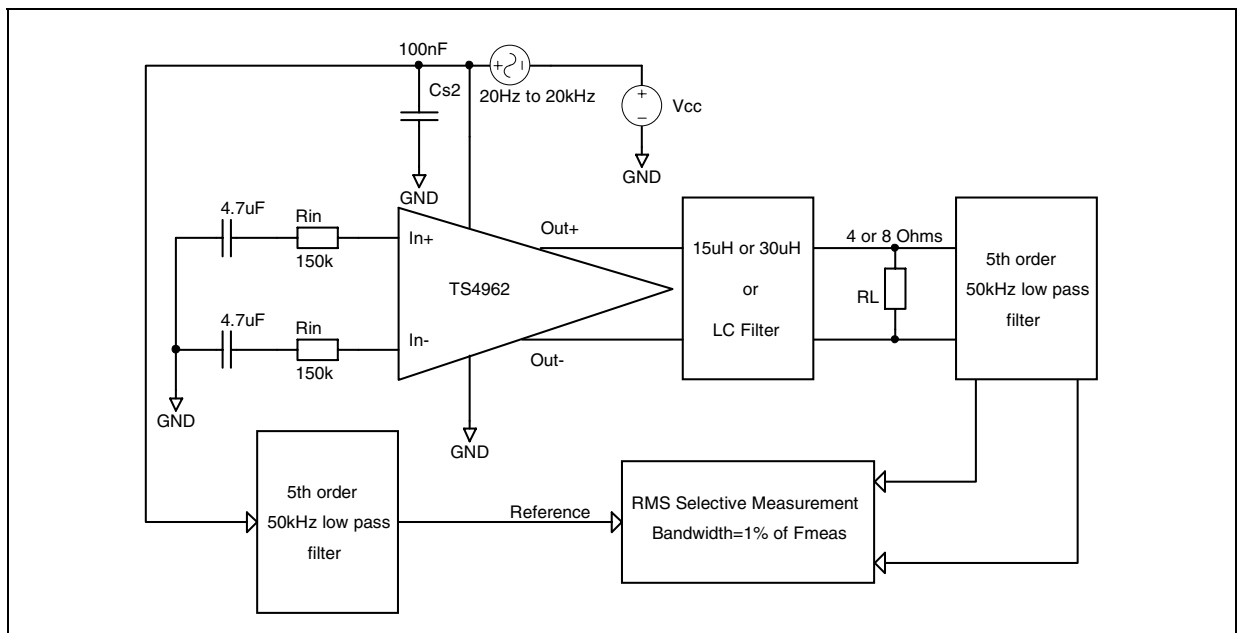

Figure 4. Current consumption vs power supply voltage

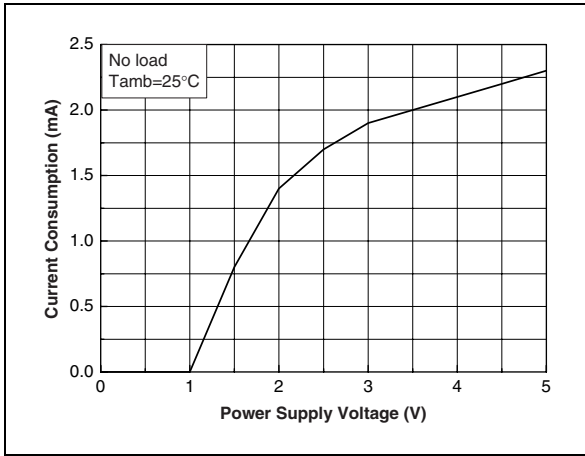

Figure 5. Current consumption vs standby voltage

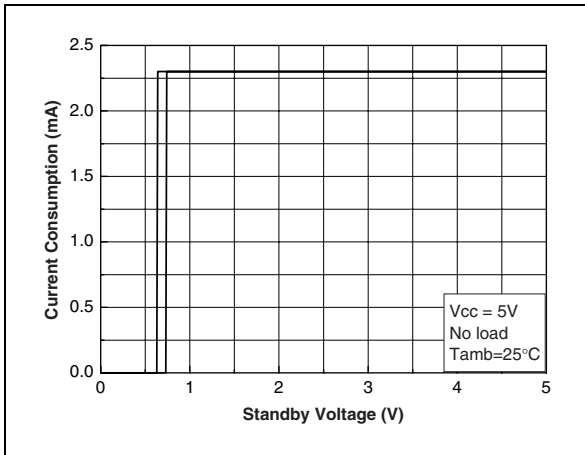

Figure 6. Current consumption vs standby voltage

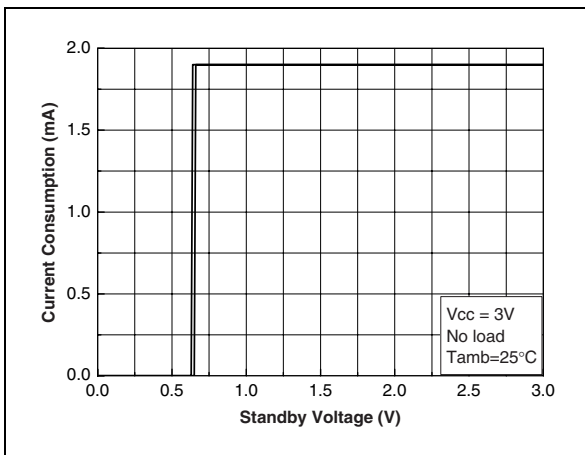

Figure 7. Output offset voltage vs common mode input voltage

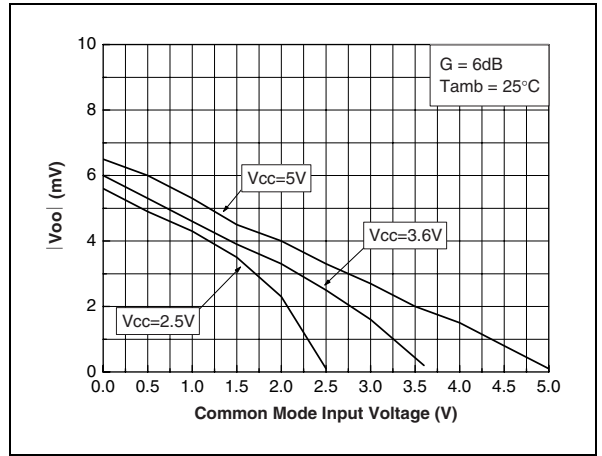

Figure 8. Efficiency vs output power

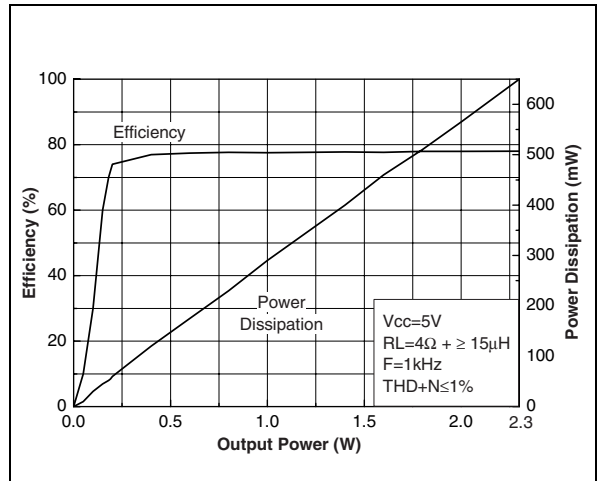

Figure 9. Efficiency vs output power

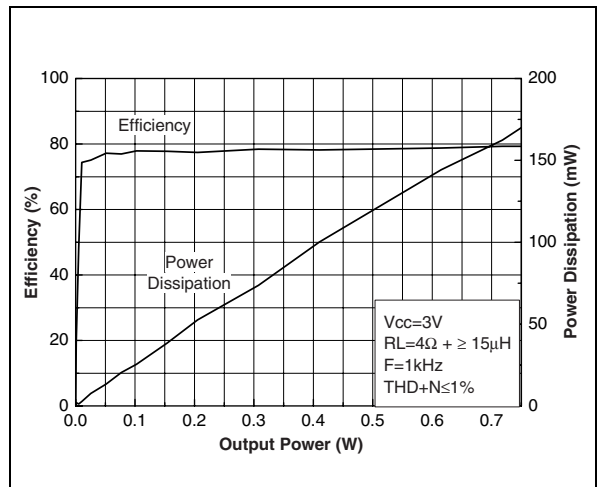

Figure 10. Efficiency vs output power

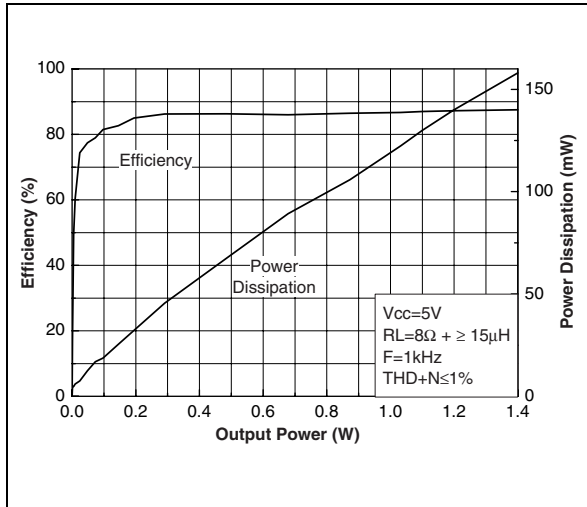

Figure 11. Efficiency vs output power

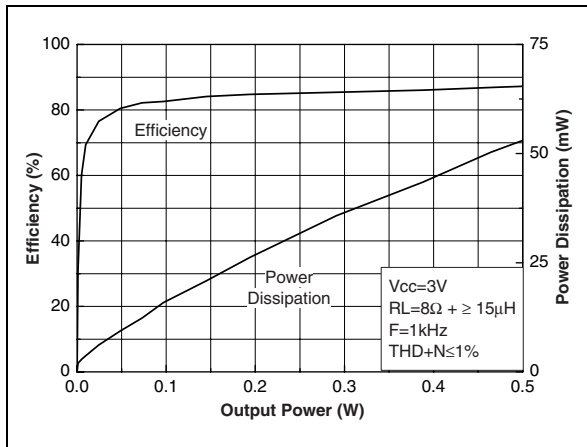

Figure 12. Output power vs power supply voltage

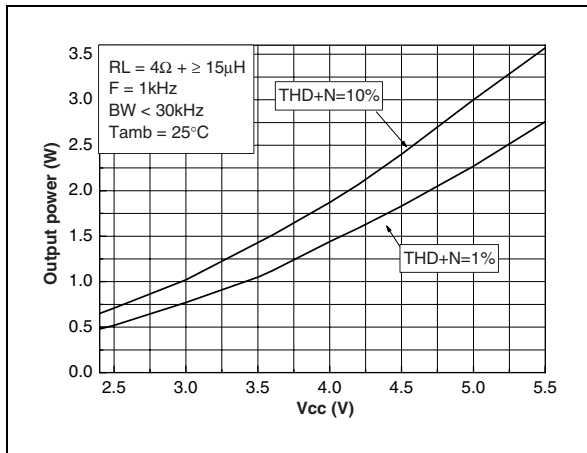

Figure 13. Output power vs power supply voltage

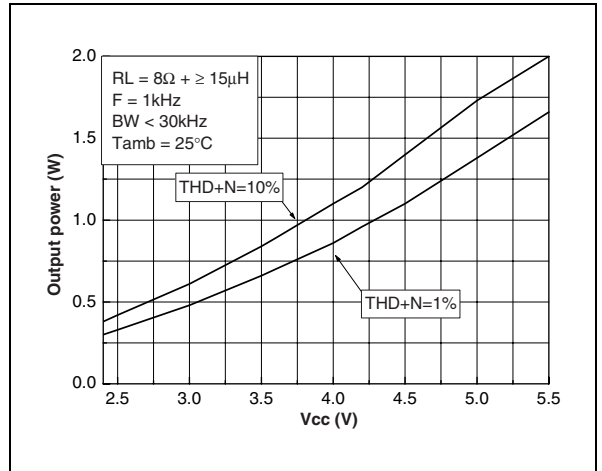

Figure 14. PSRR vs frequency

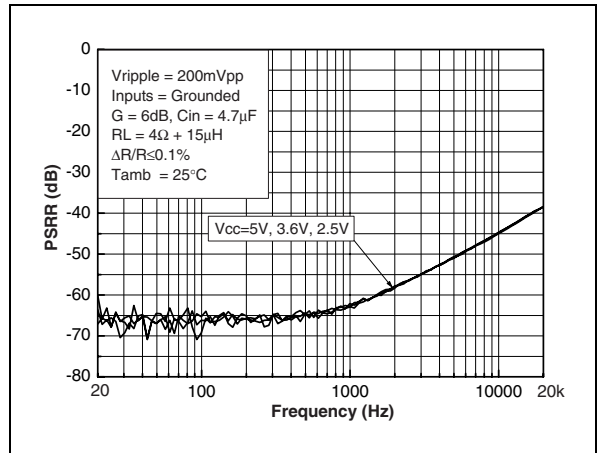

Figure 15. PSRR vs frequency

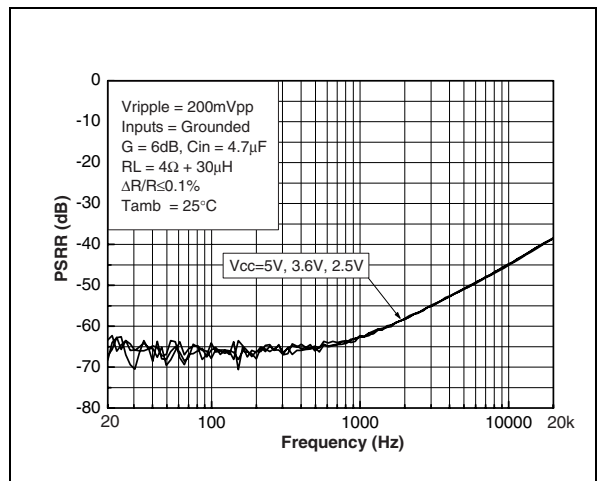

Figure 16. PSRR vs frequency

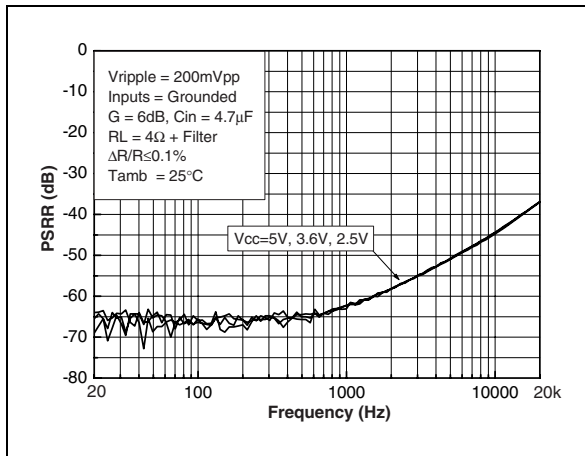

Figure 19. PSRR vs frequency

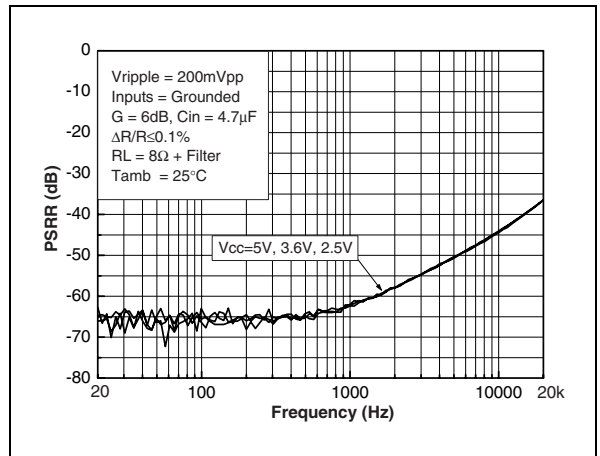

Figure 17. PSRR vs frequency

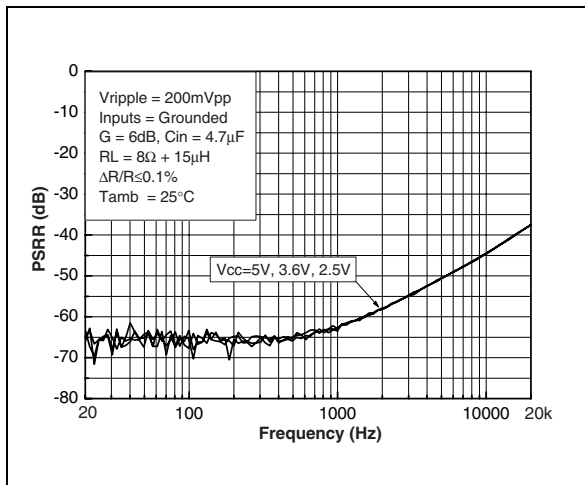

Figure 20. PSRR vs frequency Common Mode Input Voltage

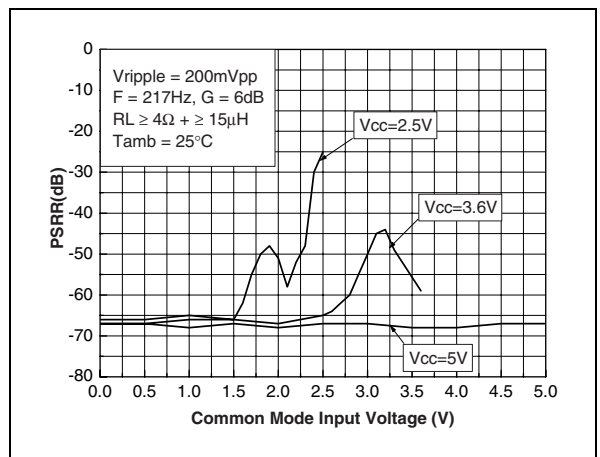

Figure 18. PSRR vs frequency

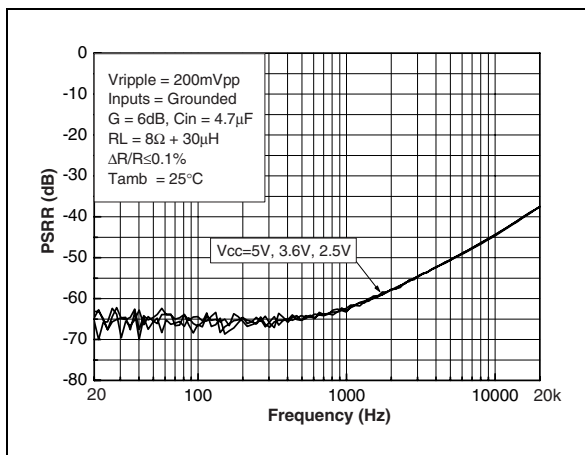

Figure 21. CMRR vs frequency

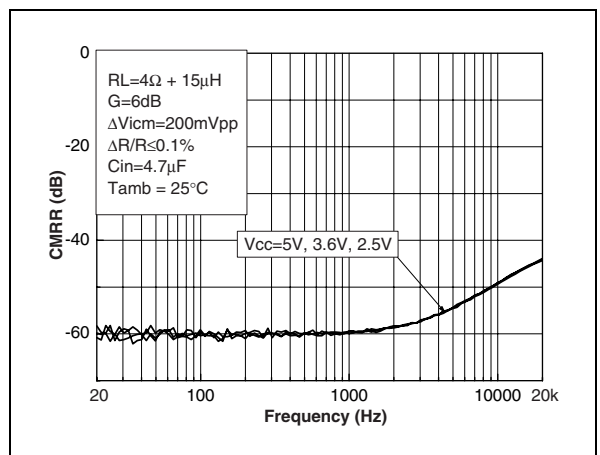

Figure 22. CMRR vs frequency

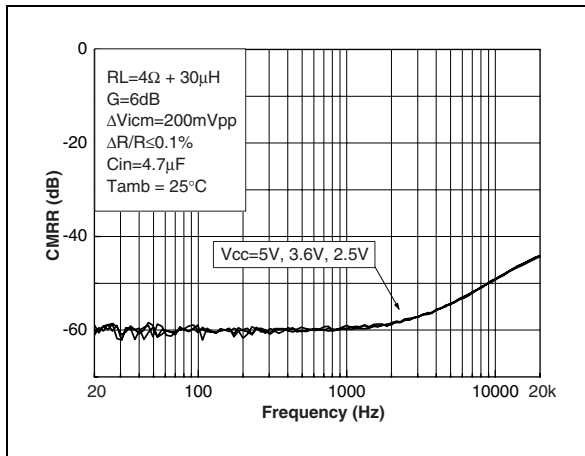

Figure 25. CMRR vs frequency

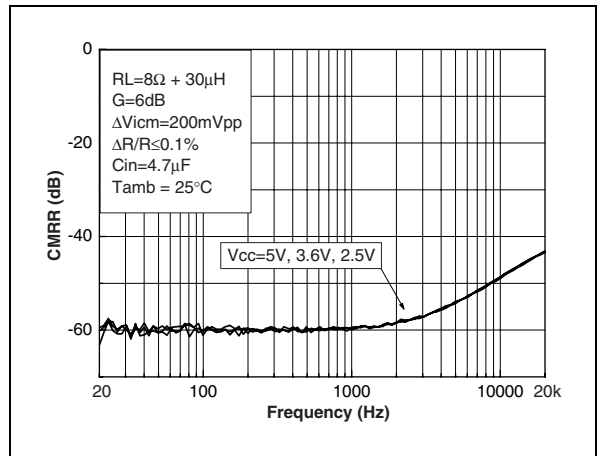

Figure 23. CMRR vs frequency

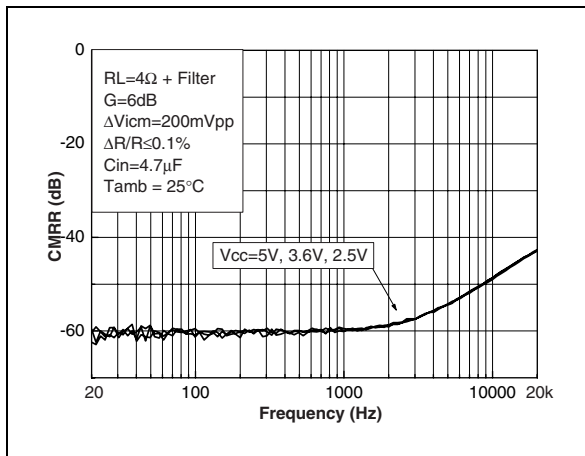

Figure 26. CMRR vs frequency

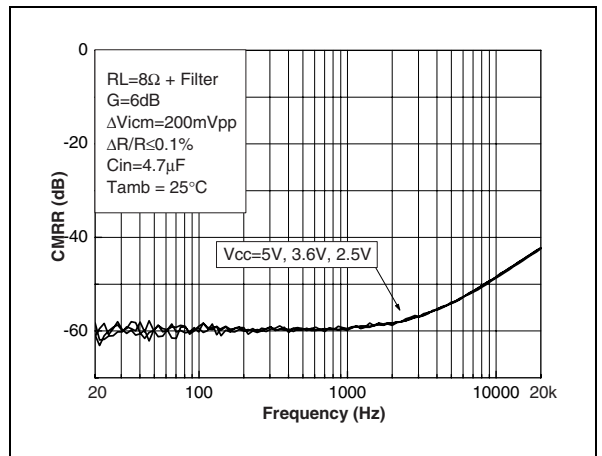

Figure 24. CMRR vs frequency

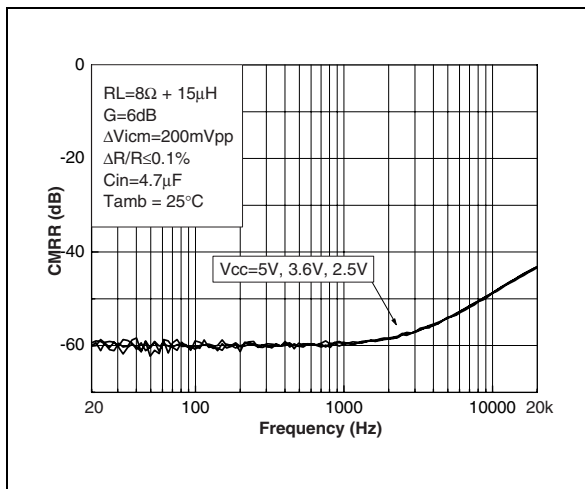

Figure 27. CMRR vs frequency Common Mode Input Voltage

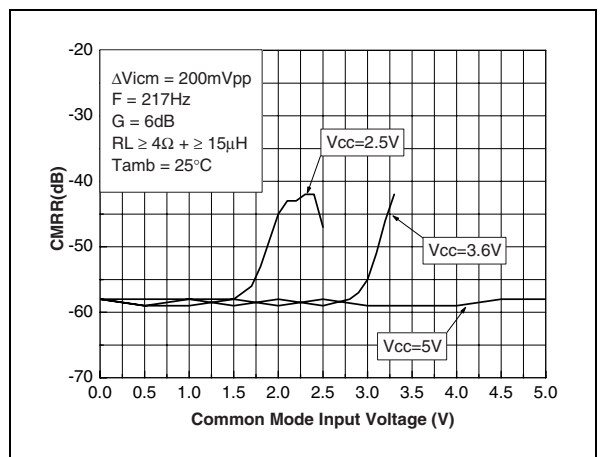

Figure 28. THD+N vs output power

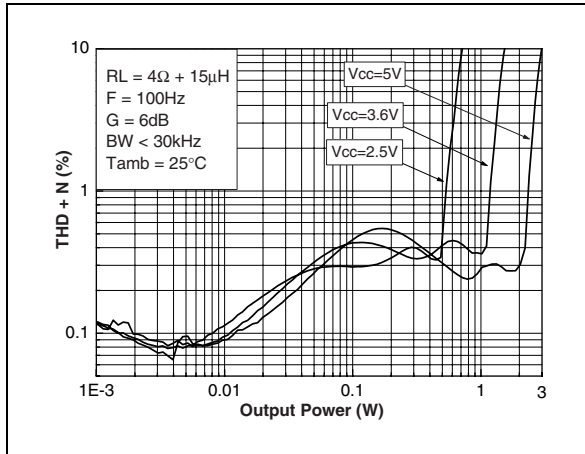

Figure 31. THD+N vs output power

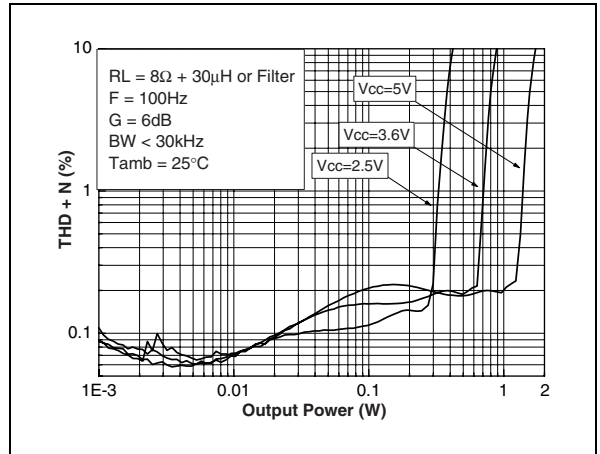

Figure 29. THD+N vs output power

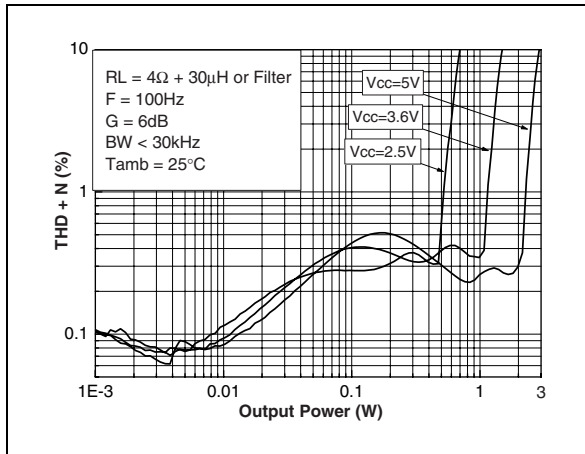

Figure 32. THD+N vs output power

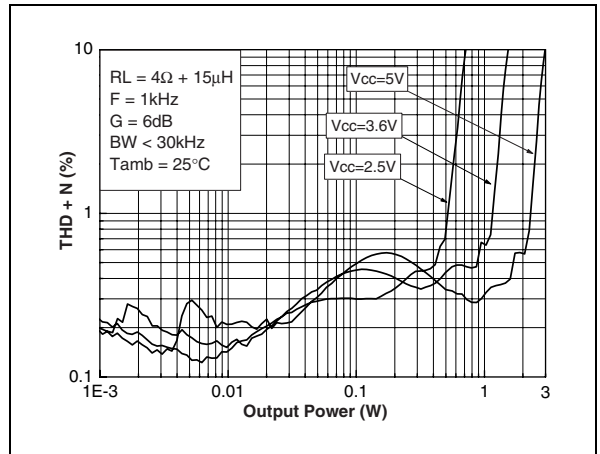

Figure 30. THD+N vs output power

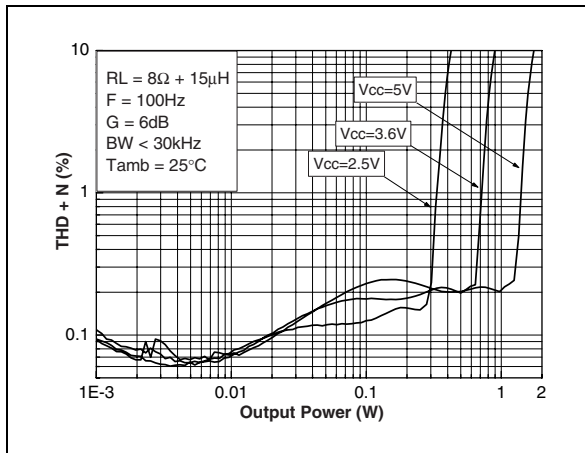

Figure 33. THD+N vs output power

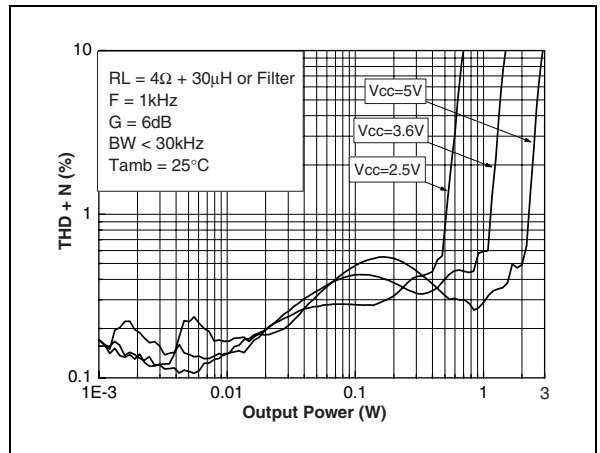

Figure 34. THD+N vs output power

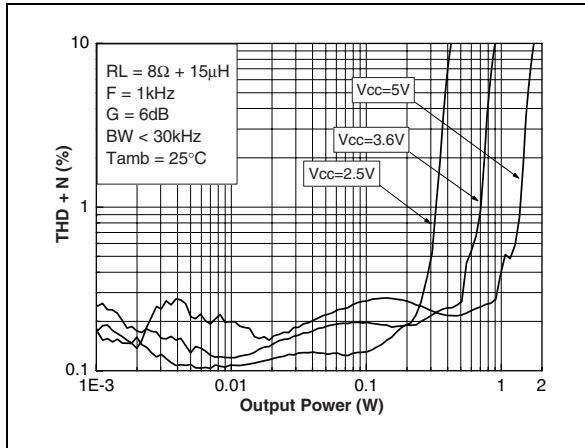

Figure 37. THD+N vs frequency

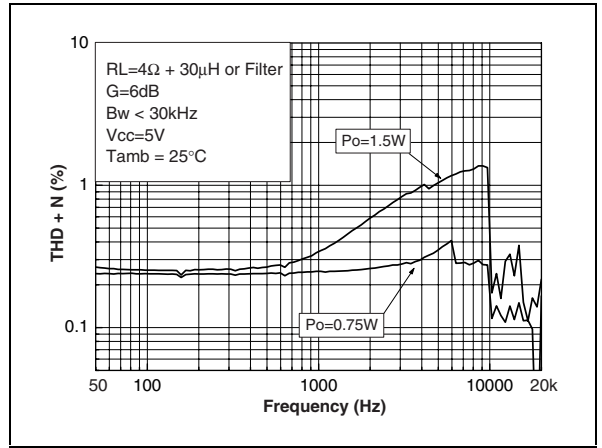

Figure 35. THD+N vs output power

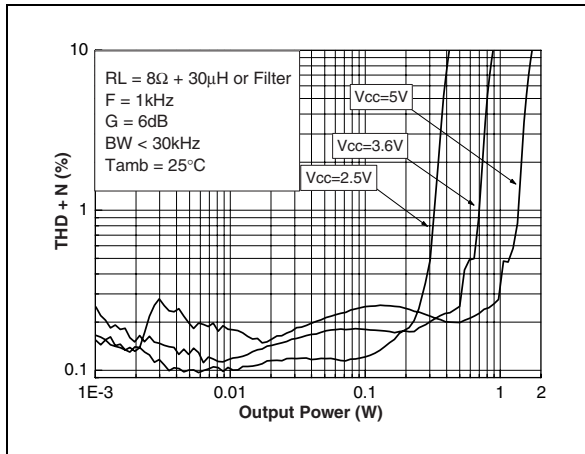

Figure 38. THD+N vs frequency

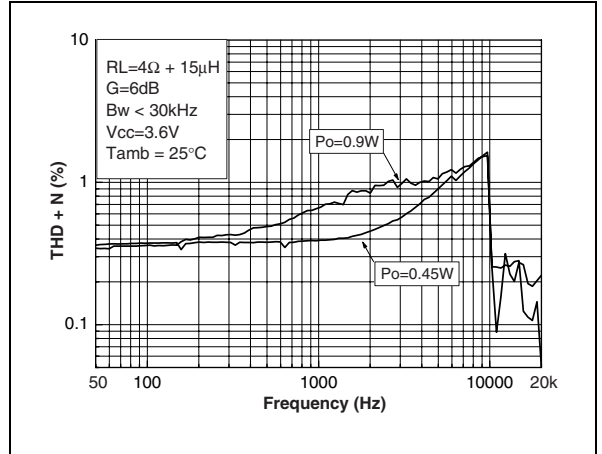

Figure 36. THD+N vs frequency

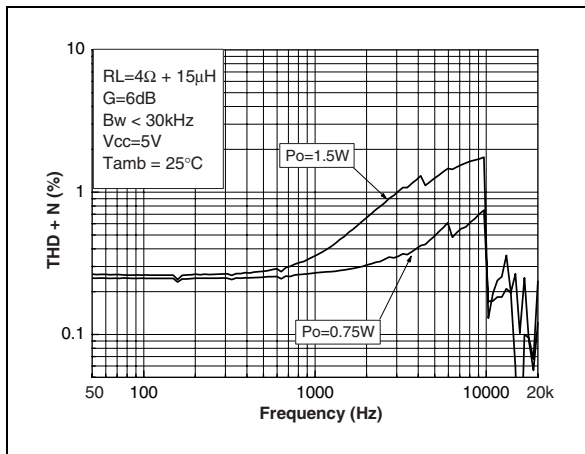

Figure 39. THD+N vs frequency

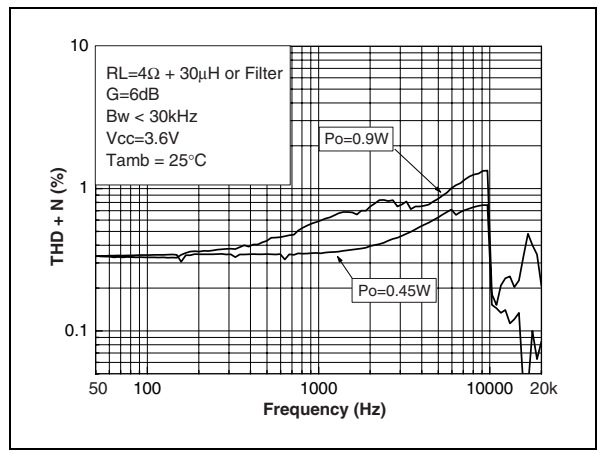

Figure 40. THD+N vs frequency

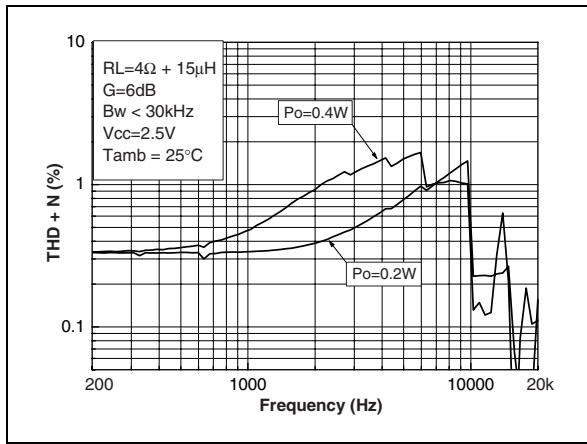

Figure 43. THD+N vs frequency

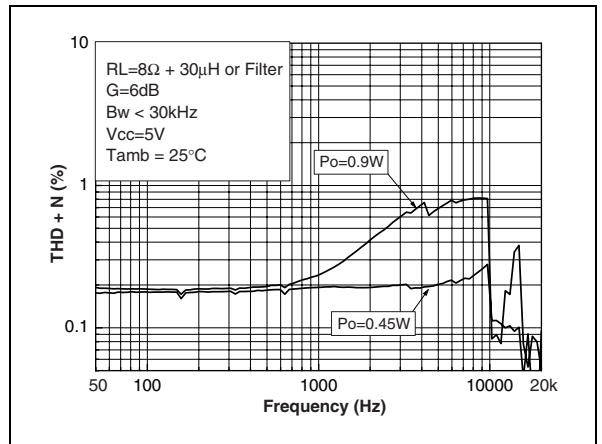

Figure 41. THD+N vs frequency

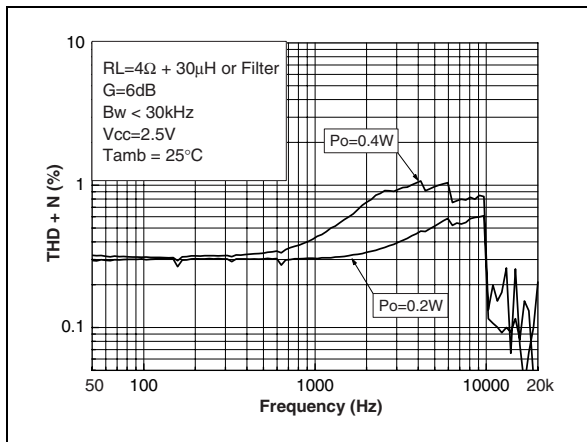

Figure 44. THD+N vs frequency

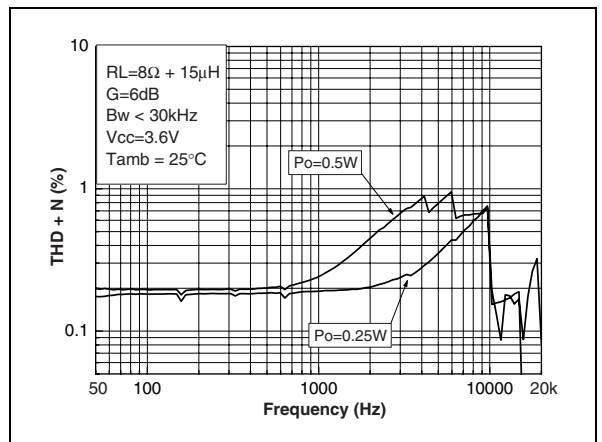

Figure 42. THD+N vs frequency

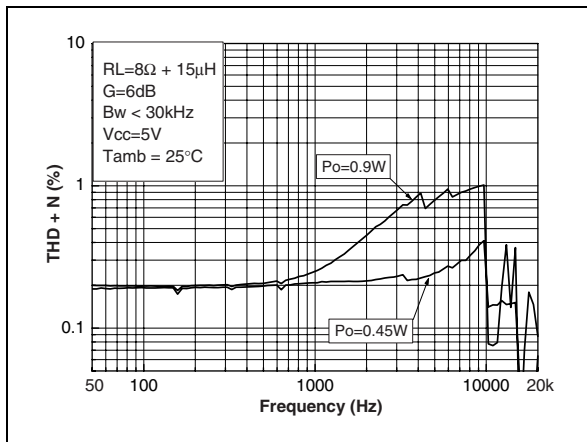

Figure 45. THD+N vs frequency

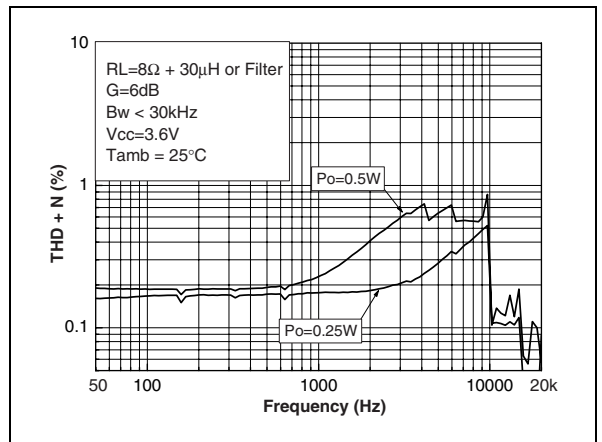

Figure 46. THD+N vs frequency

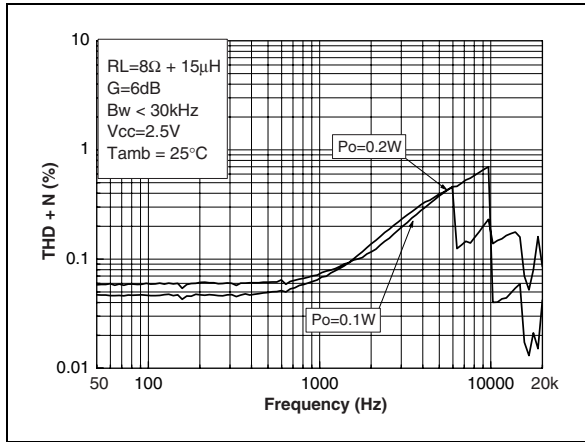

Figure 49. Gain vs frequency

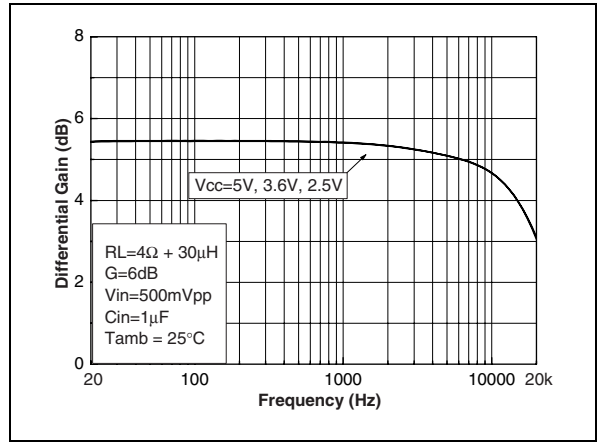

Figure 47. THD+N vs frequency

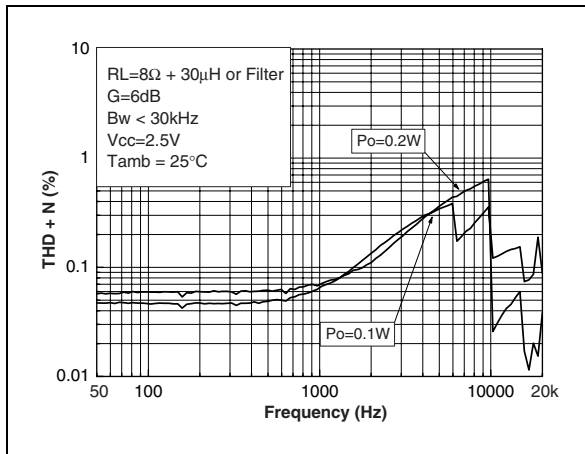

Figure 50. Gain vs frequency

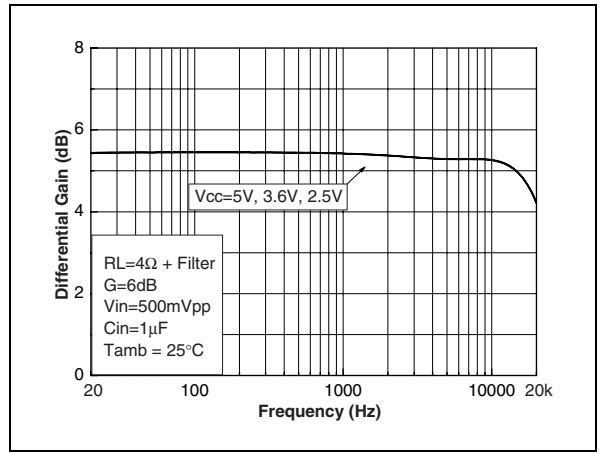

Figure 48. Gain vs frequency

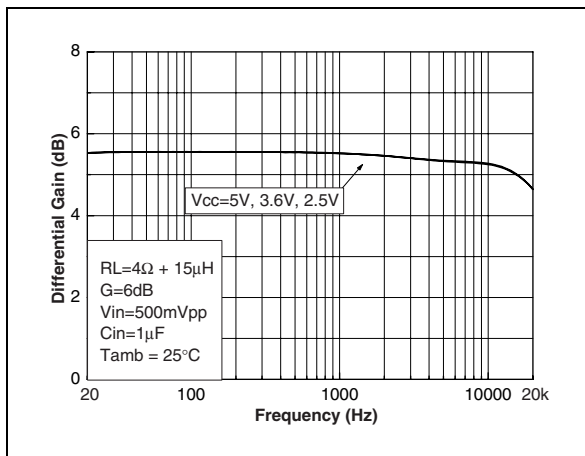

Figure 51. Gain vs frequency

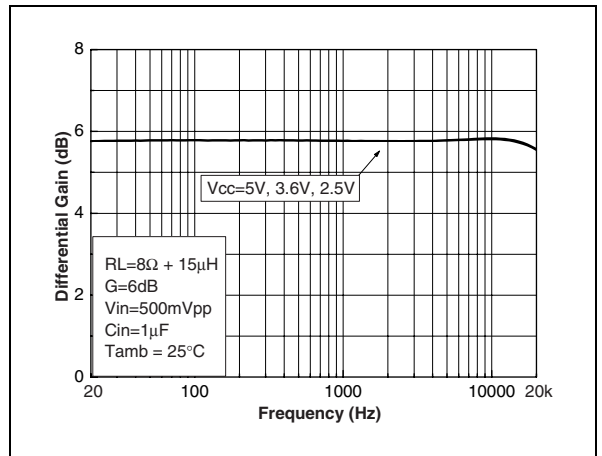

Figure 52. Gain vs frequency

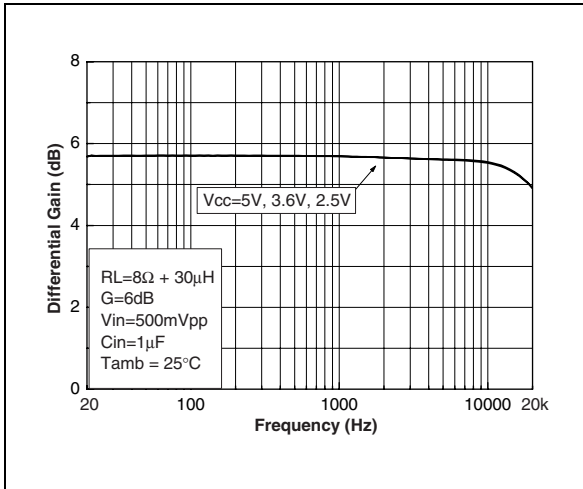

Figure 53. Gain vs frequency

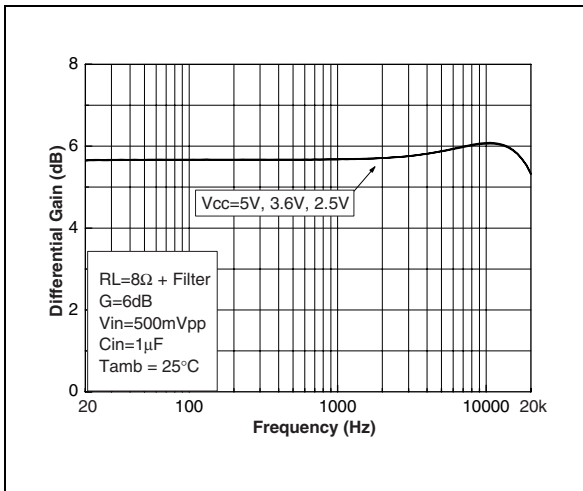

Figure 54. Gain vs frequency

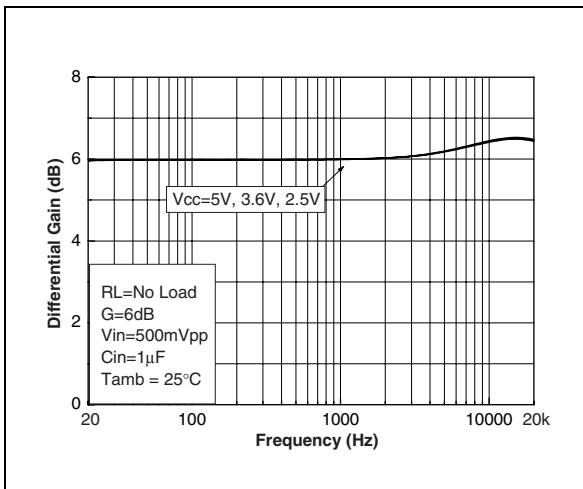

Figure 55. Startup & shutdown time
Vcc=5V, G=6dB, CIN=1μF (5ms/div)

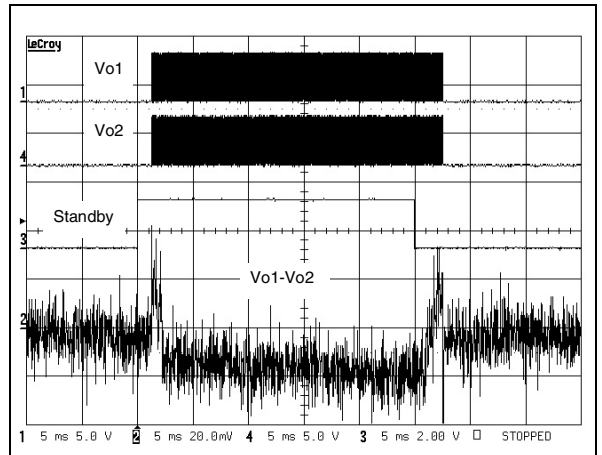

Figure 56. Startup & shutdown time
Vcc=3V, G=6dB, CIN=1μF (5ms/div)

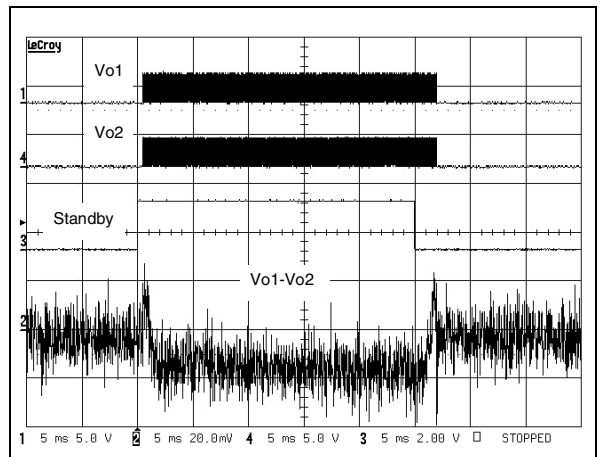

Figure 57. Startup & shutdown time
Vcc=5V, G=6dB, CIN=100nF (5ms/div)

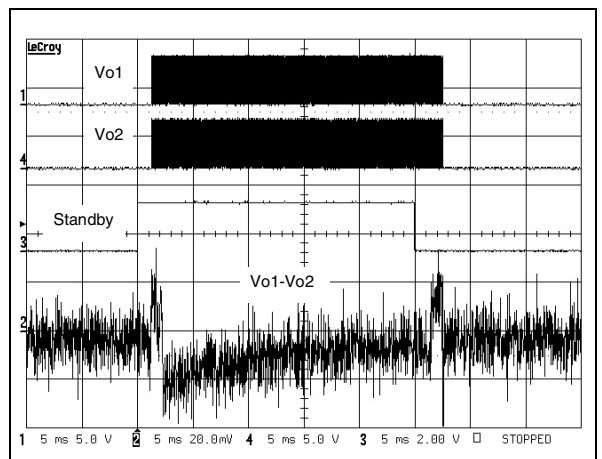

Figure 58. Startup & shutdown time
 $V_{CC}=3V$, $G=6dB$, $C_{IN}=100nF$ (5ms/div)

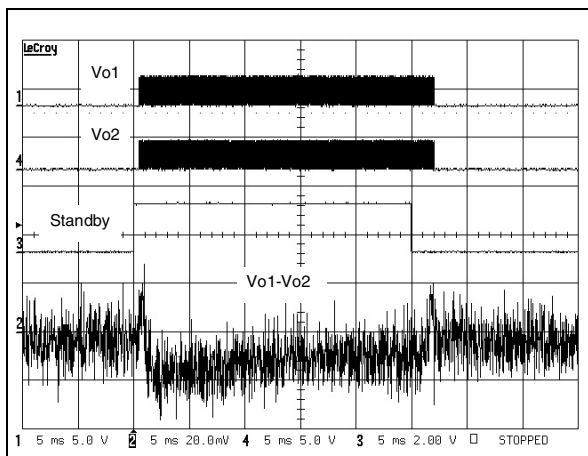

Figure 59. Startup & shutdown time
 $V_{CC}=5V$, $G=6dB$, NoC_{IN} (5ms/div)

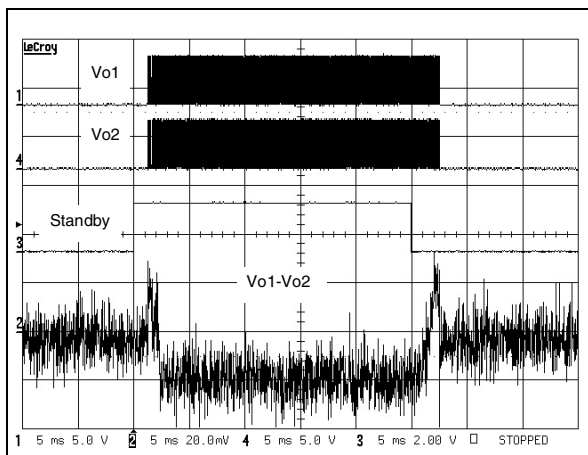
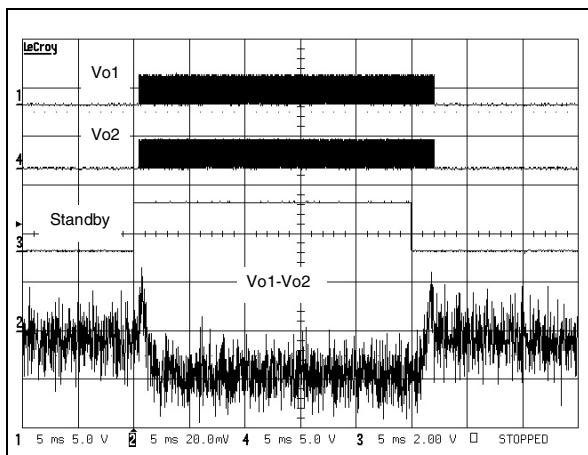

Figure 60. Startup & shutdown time
 $V_{CC}=3V$, $G=6dB$, NoC_{IN} (5ms/div)



4 Package Mechanical Data

4.1 Pin-out and markings for 9-bump flip-chip

Figure 61. Pin-out for 9-bump flip-chip (top view)

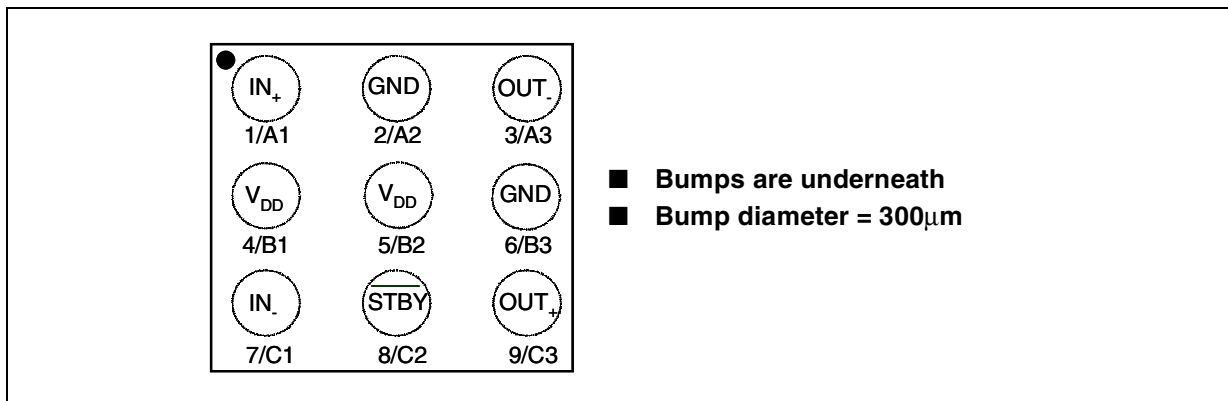
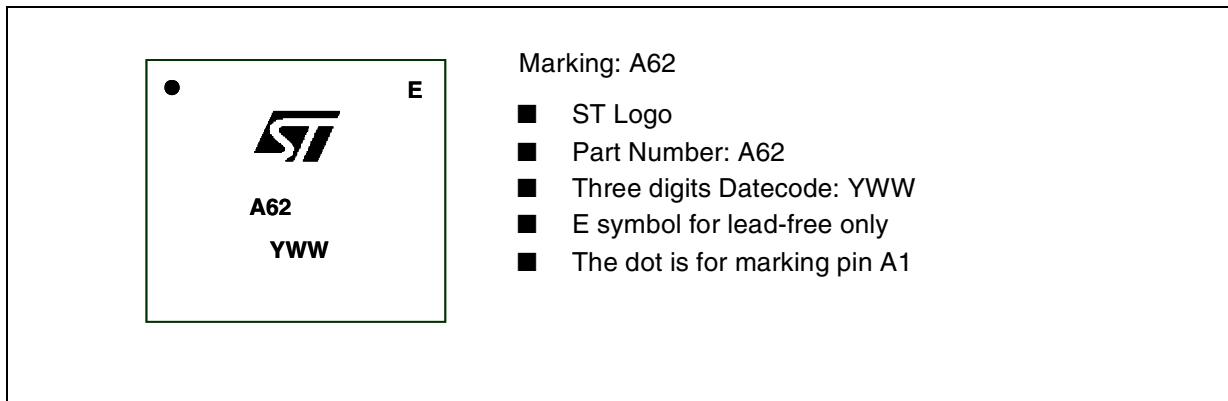
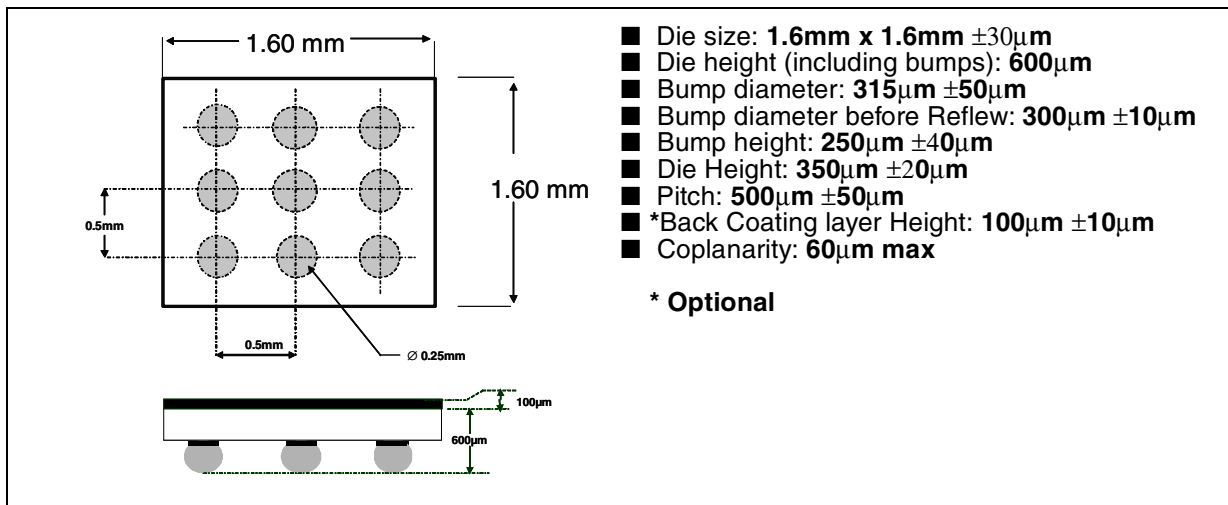

Figure 62. Marking for 9-bump flip-chip (top view)



4.2 Mechanical data for 9-bump flip-chip



5 Revision History

Date	Revision	Description of Changes
01 Sept. 2004	0.1	First release corresponding to Target Specification version of datasheet.
01 Oct. 2004	0.2	Update Gain Values.
01 Nov. 2004	1	First published version corresponding to Preliminary Data version of datasheet. Specific content changes as follows: <ul style="list-style-type: none"> • update Electrical Values + curves.
01 Jan. 2005	2	Technical parameter updated (Output Power at 3W).

Information furnished is believed to be accurate and reliable. However, STMicroelectronics assumes no responsibility for the consequences of use of such information nor for any infringement of patents or other rights of third parties which may result from its use. No license is granted by implication or otherwise under any patent or patent rights of STMicroelectronics. Specifications mentioned in this publication are subject to change without notice. This publication supersedes and replaces all information previously supplied. STMicroelectronics products are not authorized for use as critical components in life support devices or systems without express written approval of STMicroelectronics.

The ST logo is a registered trademark of STMicroelectronics
All other names are the property of their respective owners

© 2005 STMicroelectronics - All rights reserved

STMicroelectronics group of companies

Australia - Belgium - Brazil - Canada - China - Czech Republic - Finland - France - Germany - Hong Kong - India - Israel - Italy - Japan - Malaysia - Malta - Morocco - Singapore - Spain - Sweden - Switzerland - United Kingdom - United States of America

www.st.com