



CTA30/CTB35

400/600/800V - TRIAC

Applications

- Phase Control
- Static Switching
- Light Dimming
- Motor Speed Control
- Kitchen Equipment
- Power Tools
- Solenoid Valve Controls:
 - Dishwashers
 - Washing Machines

- > Suitable for General Purpose AC Switching
- > IGT 50mA
- > VDRM/VRMM 400, 600, 800V

Absolute Maximum Ratings

	CONDITIONS	SYMBOL	RATING
RMS On-State Current (full sine wave)	T _c = 95°C	TO-220AB	35A (CTB)
	T _c = 70°C	TO-220AB Iso	30A (CTA)
Non Repetitive Surge Peak On-State Current (Full Cycle, T _j Initial = 25°C)	F = 50 Hz	I _{TSM}	335A
	F = 60 Hz		350A
I ² t Value for fusing	tp = 10 ms	I ² t	500A ² s
Critical rate of rise of on-state current I _G = 2 x I _{GT} , tr < 100 ns, T _j = 125°C		di/dt	100A/μsec
Peak Gate Current @ T _j = 125°C	tp = 20 μs	I _{GM}	4A
Average Gate Power Dissipation @ T _j = 125°C		PG(AV)	1W
Storage Temperature Range		T _{stg}	-40 to +150°C
Operating Junction Temperature Range		T _j	-40 to +125°C
Isolation Voltage (CTA Series only)		V _{ISO}	2500 V _{RMS}

Electrical Characteristics

STANDARD (4 Quadrants)		"B"	
I _{GT} MAX @ V _D = 12 V, R _L = 30Ω ^{NOTE 1}	QI-II-III	50mA	
I _{GT} MAX @ V _D = 12 V, R _L = 30Ω ^{NOTE 1}	QIV	100 mA	
V _{GT} MAX @ V _D = 12 V, R _L = 30Ω	Q-AII	1.3V	
V _{GD} MIN @ V _D = V _{DRM} , R _L = 3.3kΩ	T _j = 125°C	Q-AII	0.2 V
I _H MAX @ I _T = 500 mA ^{NOTE 2}			75mA
I _L MAX @ I _G = 1.2 I _{GT}	QI-III-IV		75mA
I _L MAX @ I _G = 1.2 I _{GT}	Q-II		100mA
dv/dt MIN @ V _D = 67% V _{DRM} (gate open) ^{NOTE 2}	T _j = 125°C		500V/μsec
(dv/dt) _c MIN @ (di/dt) _c = 13.3 A/ms ^{NOTE 2}	T _j = 125°C		10V/μsec

Static Characteristics

V _T MAX @ I _{TM} = 48 A, tp = 380μs ^{NOTE 2}	T _j = 25°C	1.55 V
V _{to} MAX @ Threshold Voltage ^{NOTE 2}	T _j = 125°C	0.85 V
R _d MAX @ Dynamic Resistance ^{NOTE 2}	T _j = 125°C	16 mΩ
I _{DRM} MAX @ V _{DRM} = V _{RDM}	T _j = 25°C	5μA
I _{RRM} MAX @ V _{DRM} = V _{RDM}	T _j = 125°C	3 mA

GENERAL NOTES

1. Minimum IGT is guaranteed at 5% of IGT max.
2. For both polarities of A2 referenced to A1
3. All parameters at 25 degrees C unless otherwise specified.

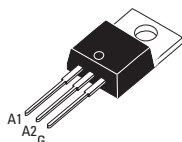

TO-220AB Isolated (CTA30)

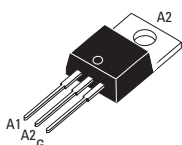

TO-220AB Non-Isolated (CTB35)



ISO9001 Certified

Thermal Resistances

	SYMBOL	RATING
Junction to Case (AC)	TO-220AB	$R_{th(j-c)}$ 0.8°C/W
Junction to Case (AC)	TO-220AB Isolated	$R_{th(j-c)}$ 1.7°C/W
Junction to Ambient	TO-220AB	$R_{th(j-a)}$ 60°C/W
Junction to Ambient	TO-220AB Isolated	$R_{th(j-a)}$ 60°C/W

Part Number Selection

Part Number	Voltage [Vpk]	I_{CT} [mA]	Type	Package
CTA30-xxxB	400, 600, 800	50mA	Standard	TO-220AB
CTB35-xxxB	400, 600, 800	50mA	Standard	TO-220AB

Part Number Designation

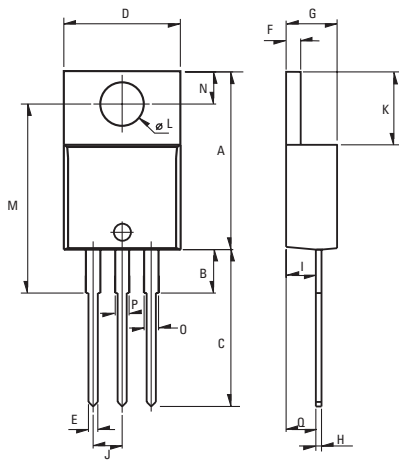
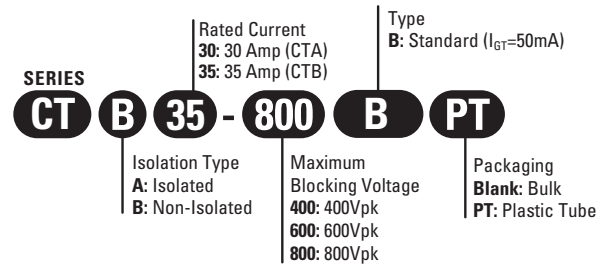

Weight: 2.3g (0.08 oz)

Dimensions

REF.	Millimeters			Inches		
	Min.	Typ.	Max.	Min.	Typ.	Max.
A	15.24		15.75	0.6		0.62
B		3.23			0.127	
C	12.78		13.79	0.503		0.543
D	9.96		10.36	0.392		0.408
E	0.69		0.94	0.027		0.037
F	1.22		1.32	0.048		0.052
G	4.62		4.83	0.182		0.19
H	0.46		0.61	0.018		0.024
I	2.49		2.84	0.098		0.112
J	2.39		2.69	0.094		0.106
K	6.48		6.88	0.255		0.271
L	3.78		3.89	0.149		0.153
M	15.49	16	16.51	0.61	0.63	0.65
N	2.59		2.9	0.102		0.114
O	0.99		1.55	0.039		0.061
P	0.99		1.55	0.039		0.061
Q		2.67			0.105	

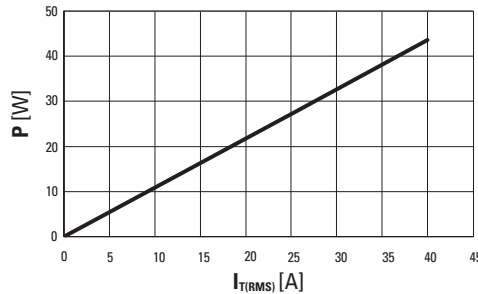

Fig. 1: Power dissipation versus RMS on-state current (full cycle).

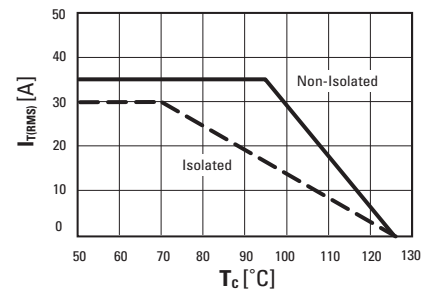

Fig. 2: RMS on-state current versus case temperature (full cycle)

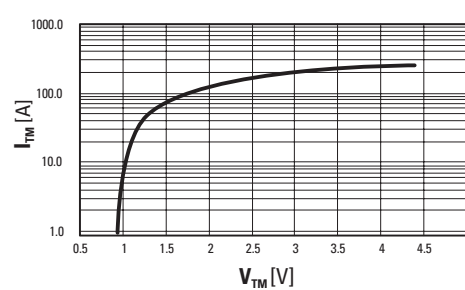

Fig. 3: On-state current versus on-state voltage (instantaneous values)

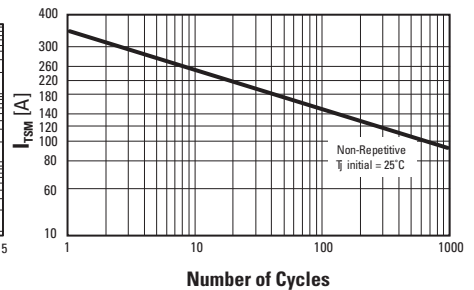

Fig. 4: Non-repetitive surge peak on-state current versus number of cycles.

ISO9001 Certified

Approvals

UL Recognized Component - E72445
(For CTA30)

USA

Sales Support (877) 502-5500
Tech Support (877) 702-7700
Fax (619) 710-8540
Email: sales@crydom.com
Crydom Corp
2320 Paseo de las Americas, Suite 201
San Diego, CA 92154

EUROPE - UK

Telephone +44 (0) 1202 365070
Fax +44 (0) 1202 365090
Email: intsales@crydom.com
Crydom International Ltd.
7 Cobham Road
Ferndown Industrial Estate
Wimborne, Dorset BH21 7PE

Germany

Telephone +49 (0) 180 3000 506

ASIA - Thailand

Telephone +66 (0)2 665 2517
Fax +66 (0)2 665 2588
Crydom Asia
18/8 Fico Place 12th Floor
Soi Sukhumvit 21 (Asoke)
Klongtoey Nua, Wattana
Bangkok, Thailand 10110