



COMPLEMENTARY SILICON POWER TRANSISTORS

- COMPLEMENTARY PNP - NPN DEVICES

APPLICATION

- LINEAR AND SWITCHING INDUSTRIAL EQUIPMENT

DESCRIPTION

The BD707, BD709 and BD711 are silicon Epitaxial-Base NPN power transistors in Jedec TO-220 plastic package. They are intended for use in power linear and switching applications. The BD707 and BD711 complementary PNP types are BD708 and BD712 respectively.

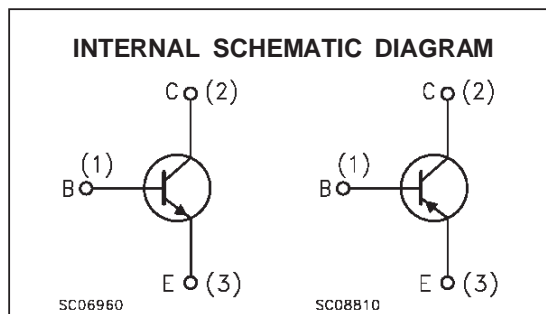
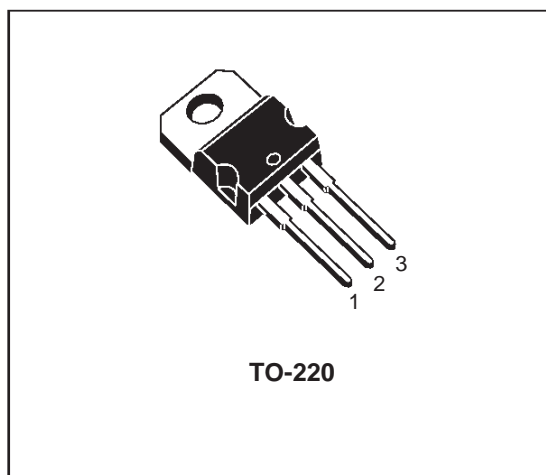

ABSOLUTE MAXIMUM RATINGS

| Symbol | Parameter | Value | | | Unit | |
|-----------|--|------------|----------------|-------------------------|------|------------------|
| | | NPN PNP | BD707 BD708 | BD709 BD711 BD712 | | |
| V_{CBO} | Collector-Base Voltage ($I_E = 0$) | | 60 | 80 | 100 | V |
| V_{CER} | Collector-Emitter Voltage ($V_{BE} = 0$) | | 60 | 80 | 100 | V |
| V_{CEO} | Collector-Emitter Voltage ($I_B = 0$) | | 60 | 80 | 100 | V |
| V_{EBO} | Emitter-Base Voltage ($I_C = 0$) | | 5 | | | V |
| I_C | Collector Current | | 12 | | | A |
| I_{CM} | Collector Peak Current | | 18 | | | A |
| I_B | Base Current | | 5 | | | A |
| P_{tot} | Total Dissipation at $T_c \leq 25^\circ\text{C}$ | | 75 | | | W |
| T_{stg} | Storage Temperature | | -65 to 150 | | | $^\circ\text{C}$ |
| T_j | Max. Operating Junction Temperature | | 150 | | | $^\circ\text{C}$ |

For PNP types voltage and current values are negative

THERMAL DATA

| | | | | |
|-----------------------|-------------------------------------|-----|------|------|
| R _{thj-case} | Thermal Resistance Junction-case | Max | 1.67 | °C/W |
| R _{thj-case} | Thermal Resistance Junction-ambient | Max | 70 | °C/W |

ELECTRICAL CHARACTERISTICS (T_{case} = 25 °C unless otherwise specified)

| Symbol | Parameter | Test Conditions | Min. | Typ. | Max. | Unit |
|------------------------|---|--|---------------------------|-----------------------------|----------------------------------|----------------------------------|
| I _{CBO} | Collector Cut-off Current (I _E = 0) | for BD707/708 V _{CB} = 60 V for BD709 V _{CB} = 80 V for BD711/712 V _{CB} = 100 V T _{case} = 150 °C for BD707/708 V _{CB} = 60 V for BD709 V _{CB} = 80 V for BD711/712 V _{CB} = 100 V | | | 100 100 100 1 1 1 | μA μA μA mA mA mA |
| I _{CEO} | Collector Cut-off Current (I _B = 0) | for BD707/708 V _{CE} = 30 V for BD709 V _{CE} = 40 V for BD711/712 V _{CE} = 50 V | | | 100 100 100 | mA mA mA |
| I _{EBO} | Emitter Cut-off Current (I _C = 0) | V _{EB} = 5 V | | | 1 | mA |
| V _{CEO(sus)*} | Collector-Emitter Sustaining Voltage (I _B = 0) | I _C = 100 mA for BD707/708 for BD709 for BD711/712 | 60 80 100 | | | V V V |
| V _{CE(sat)*} | Collector-Emitter Saturation Voltage | I _C = 4 A I _B = 0.4 A | | | 1 | V |
| V _{CEK*} | Knee Voltage | I _C = 3 A I _B = ** | | | 0.4 | V |
| V _{BE*} | Base-Emitter Voltage | I _C = 4 A V _{CE} = 4 V | | | 1.5 | V |
| h _{FE*} | DC Current Gain | I _C = 0.5 A V _{CE} = 2 V I _C = 2 A V _{CE} = 2 V for BD707/708 for BD709 I _C = 4 A V _{CE} = 4 V I _C = 10 A V _{CE} = 4 V for BD707/708 for BD709 for BD711/712 | 40 30 30 15 5 | 120 10 8 8 | 400 150 | |
| f _T | Transition frequency | I _C = 300 mA V _{CE} = 3 V | 3 | | | MHz |

* Pulsed: Pulse duration = 300 μs, duty cycle 1.5 %

** Value for which I_C = 3.3 A at V_{CE} = 2V.

For PNP types voltage and current values are negative.

Safe Operating Areas

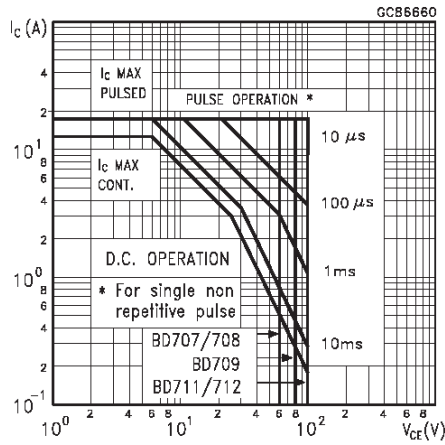

Derating Curve

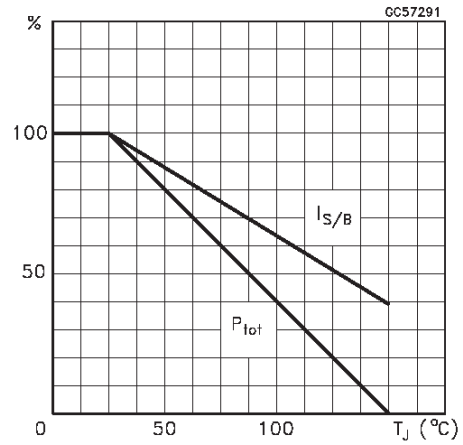

DC Current Gain(NPN type)

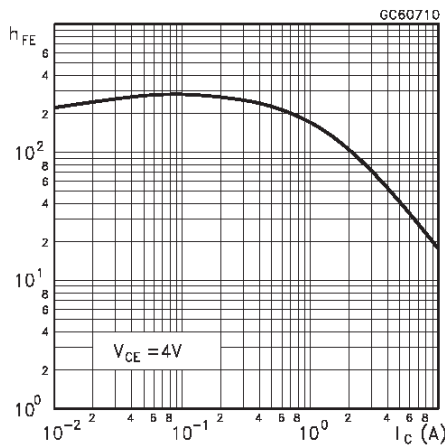

DC Current Gain(PNP type)

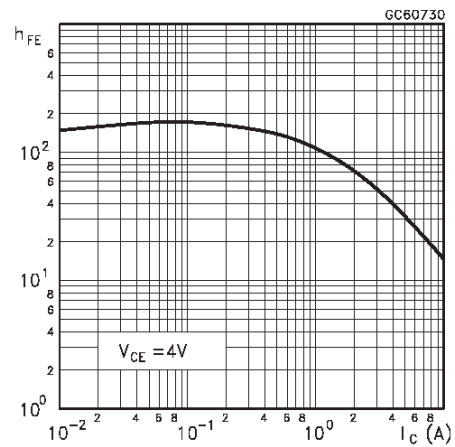

DC Transconductance(NPN type)

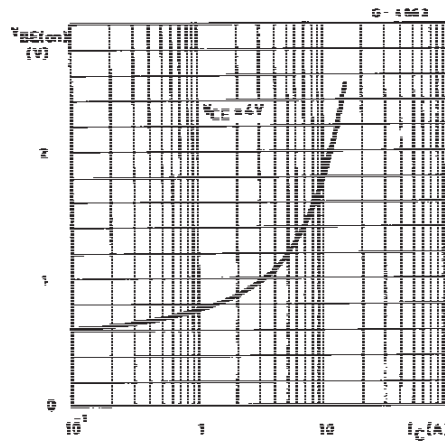

DC Transconductance(PNP type)

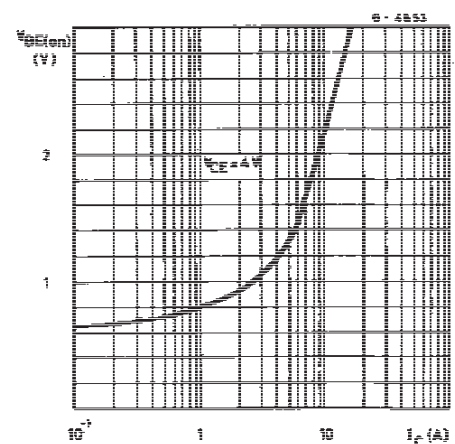

Collector-Emitter Saturation Voltage (NPN type)

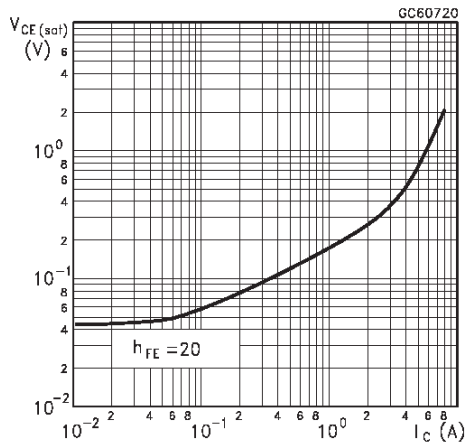

Collector-Emitter Saturation Voltage (PNP type)

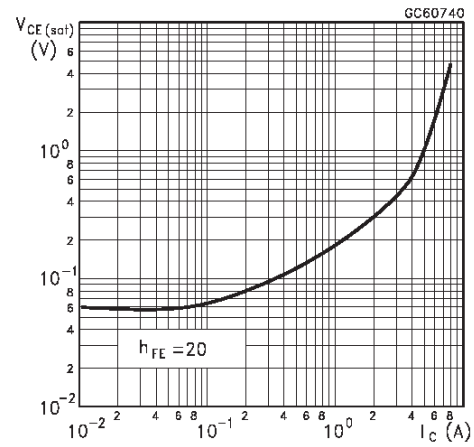

Base-Emitter Saturation Voltage (NPN type)

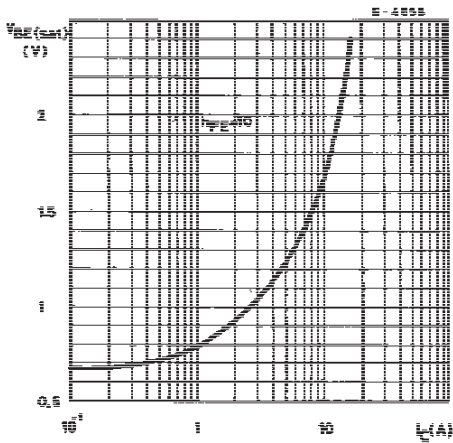

Base-Emitter Saturation Voltage (PNP type)

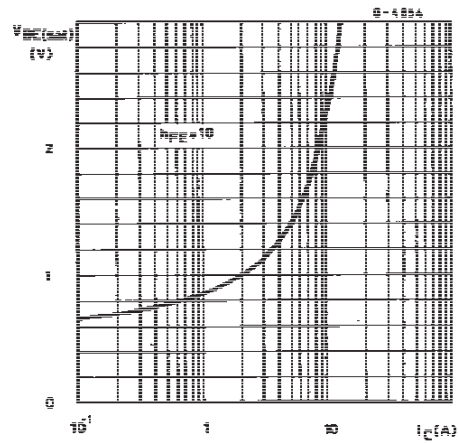

Transition Frequency (NPN type)

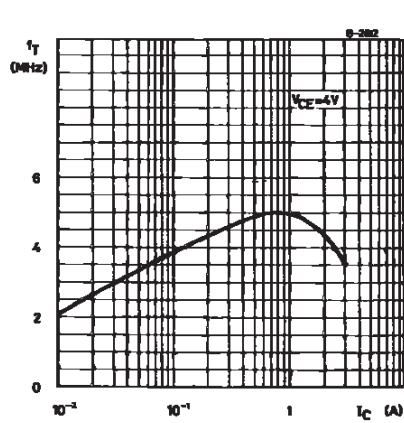

Transition Frequency (PNP type)

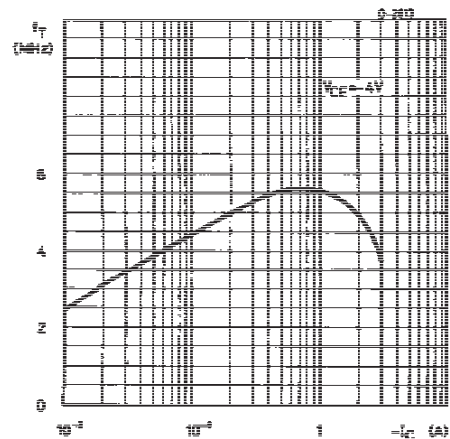

TO-220 MECHANICAL DATA

| DIM. | mm | | | inch | | |
|------|-------|------|-------|-------|-------|-------|
| | MIN. | TYP. | MAX. | MIN. | TYP. | MAX. |
| A | 4.40 | | 4.60 | 0.173 | | 0.181 |
| C | 1.23 | | 1.32 | 0.048 | | 0.051 |
| D | 2.40 | | 2.72 | 0.094 | | 0.107 |
| D1 | | 1.27 | | | 0.050 | |
| E | 0.49 | | 0.70 | 0.019 | | 0.027 |
| F | 0.61 | | 0.88 | 0.024 | | 0.034 |
| F1 | 1.14 | | 1.70 | 0.044 | | 0.067 |
| F2 | 1.14 | | 1.70 | 0.044 | | 0.067 |
| G | 4.95 | | 5.15 | 0.194 | | 0.203 |
| G1 | 2.4 | | 2.7 | 0.094 | | 0.106 |
| H2 | 10.0 | | 10.40 | 0.393 | | 0.409 |
| L2 | | 16.4 | | | 0.645 | |
| L4 | 13.0 | | 14.0 | 0.511 | | 0.551 |
| L5 | 2.65 | | 2.95 | 0.104 | | 0.116 |
| L6 | 15.25 | | 15.75 | 0.600 | | 0.620 |
| L7 | 6.2 | | 6.6 | 0.244 | | 0.260 |
| L9 | 3.5 | | 3.93 | 0.137 | | 0.154 |
| DIA. | 3.75 | | 3.85 | 0.147 | | 0.151 |

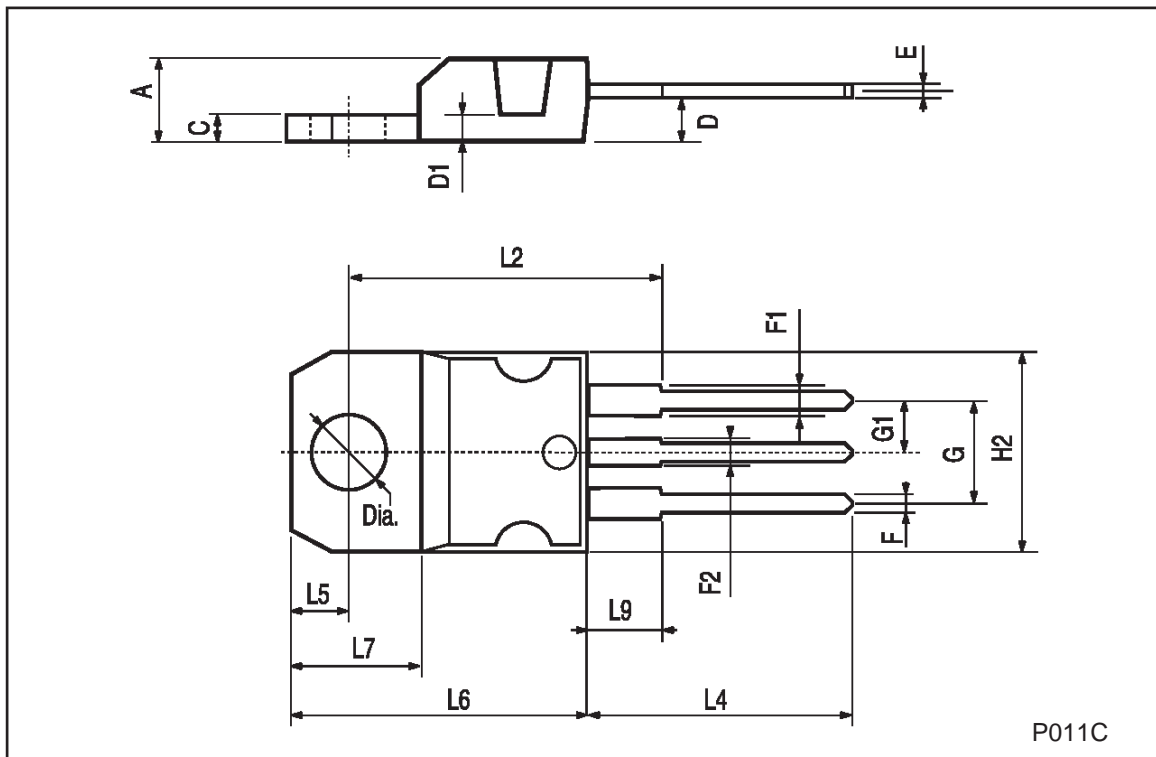

Information furnished is believed to be accurate and reliable. However, STMicroelectronics assumes no responsibility for the consequences of use of such information nor for any infringement of patents or other rights of third parties which may result from its use. No license is granted by implication or otherwise under any patent or patent rights of STMicroelectronics. Specification mentioned in this publication are subject to change without notice. This publication supersedes and replaces all information previously supplied. STMicroelectronics products are not authorized for use as critical components in life support devices or systems without express written approval of STMicroelectronics.

The ST logo is a trademark of STMicroelectronics

© 1999 STMicroelectronics – Printed in Italy – All Rights Reserved
STMicroelectronics GROUP OF COMPANIES

Australia - Brazil - China - Finland - France - Germany - Hong Kong - India - Italy - Japan - Malaysia - Malta - Morocco -
Singapore - Spain - Sweden - Switzerland - United Kingdom - U.S.A.

<http://www.st.com>