

DUAL PNP SMALL SIGNAL SURFACE MOUNT TRANSISTOR

Features

- Epitaxial Planar Die Construction
- Ideally Suited for Automated Assembly Processes
- Complementary NPN Type Available (DST847BDJ)
- **Lead, Halogen and Antimony Free, RoHS Compliant (Note 1)**
- **“Green” Device (Note 2)**
- **Ultra Small Package**

Mechanical Data

- Case: SOT-963
- Case Material: Molded Plastic, “Green” Molding Compound. UL Flammability Classification Rating 94V-0
- Moisture Sensitivity: Level 1 per J-STD-020
- Terminals: Finish — Matte Tin annealed over Copper leadframe. Solderable per MIL-STD-202, Method 208
- Weight: 0.0027 grams (approximate)

SOT-963



Top View

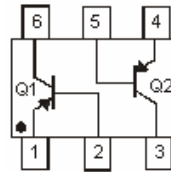

Device Schematic

Ordering Information

Device	Packaging	Shipping
DST857BDJ-7	SOT-963	10,000/Tape & Reel

- Notes:
1. No purposefully added lead. Halogen and Antimony Free.
 2. Diodes Inc's “Green” Policy can be found on our website at <http://www.diodes.com>

Marking Information

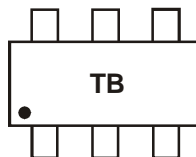

TB = Product Type Marking Code

Maximum Ratings @ $T_A = 25^\circ\text{C}$ unless otherwise specified

Characteristic	Symbol	Value	Unit
Collector-Base Voltage	V_{CBO}	-50	V
Collector-Emitter Voltage	V_{CEO}	-45	V
Emitter-Base Voltage	V_{EBO}	-5.0	V
Collector Current - Continuous (Note 3)	I_C	-100	mA

Thermal Characteristics

Characteristic	Symbol	Value	Unit
Power Dissipation (Note 3)	P_D	300	mW
Thermal Resistance, Junction to Ambient (Note 3)	$R_{\theta JA}$	417	$^\circ\text{C/W}$
Operating and Storage Temperature Range	T_J, T_{STG}	-55 to +150	$^\circ\text{C}$

Notes: 3. Device mounted on FR-4 PCB with minimum recommended pad layout.

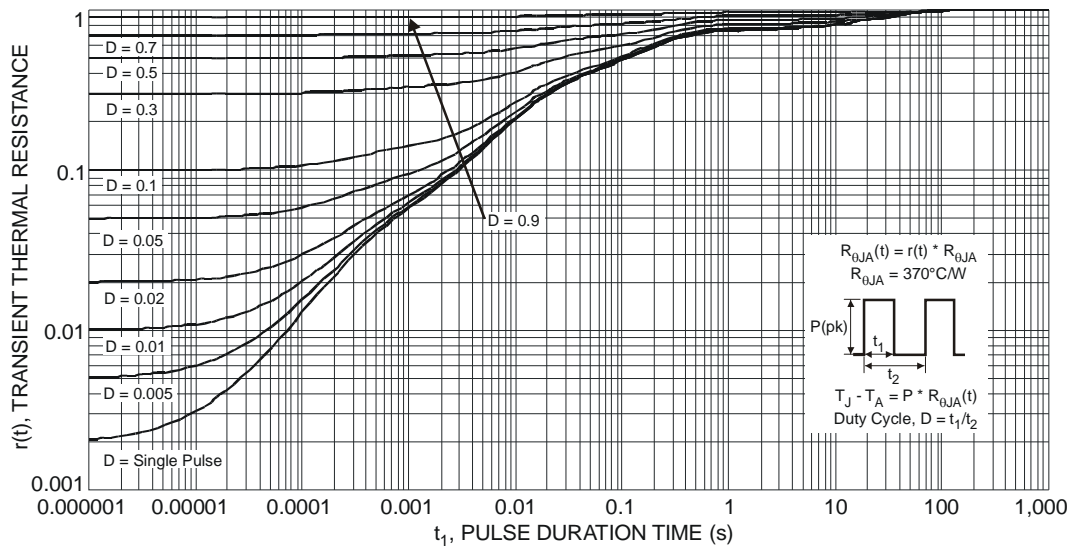

Fig. 1 Transient Thermal Response

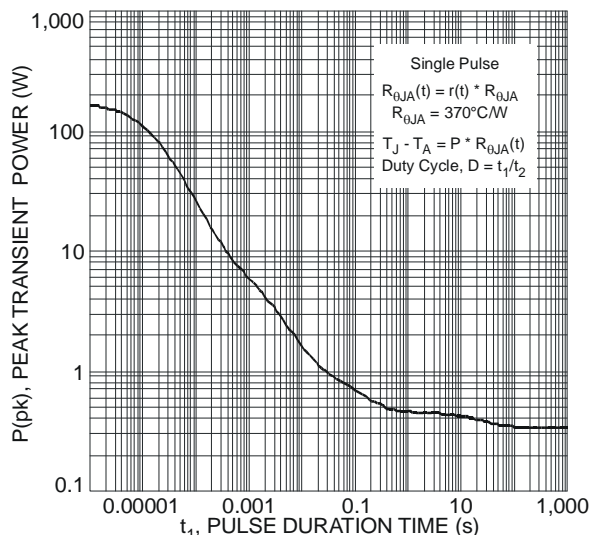

Fig. 2 Single Pulse Maximum Power Dissipation

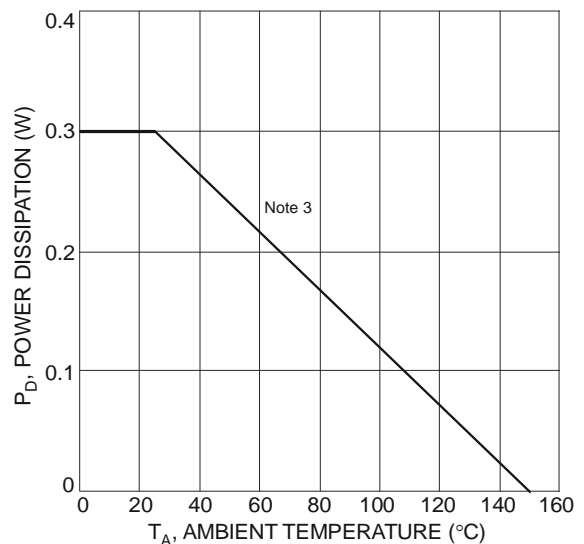

Fig. 3 Power Dissipation vs. Ambient Temperature

Electrical Characteristics @ $T_A = 25^\circ\text{C}$ unless otherwise specified

Characteristic (Note 4)	Symbol	Min	Typical	Max	Unit	Test Condition
Collector-Base Breakdown Voltage	$V_{(BR)CBO}$	-50	-100	-	V	$I_C = -10\mu\text{A}, I_B = 0$
Collector-Emitter Breakdown Voltage	$V_{(BR)CES}$	-50	-90	-	V	$I_C = -10\mu\text{A}, I_B = 0$
Collector-Emitter Breakdown Voltage	$V_{(BR)CEO}$	-45	-65	-	V	$I_C = -1\text{mA}, I_B = 0$
Emitter-Base Breakdown Voltage	$V_{(BR)EBO}$	-6	-8.5	-	V	$I_E = -1\mu\text{A}, I_C = 0$
Collector Cutoff Current	I_{CBO}	-	-	-15	nA	$V_{CB} = -30\text{V}$
DC Current Gain	h_{FE}	100	340	-	-	$I_C = -10\mu\text{A}, V_{CE} = -5\text{V}$ $I_C = -2.0\text{mA}, V_{CE} = -5\text{V}$
Collector-Emitter Saturation Voltage	$V_{CE(sat)}$	-	-70	-175	mV	$I_C = -10\text{mA}, I_B = -0.5\text{mA}$ $I_C = -100\text{mA}, I_B = -5.0\text{mA}$
Base-Emitter Saturation Voltage	$V_{BE(sat)}$	-	-760	-1000	mV	$I_C = -10\text{mA}, I_B = -0.5\text{mA}$ $I_C = -100\text{mA}, I_B = -5.0\text{mA}$
Base-Emitter Voltage	$V_{BE(on)}$	-600	-670	-780	mV	$I_C = -2.0\text{mA}, V_{CE} = -5\text{V}$ $I_C = -10\text{mA}, V_{CE} = -5\text{V}$
Current Gain-Bandwidth Product	f_T	100	340	-	MHz	$V_{CE} = -5\text{V}, I_C = -10\text{mA},$ $f = 100\text{MHz}$
Output Capacitance	C_{obo}	-	2.0	-	pF	$V_{CB} = -10\text{V}, f = 1.0\text{MHz}$

Notes: 4. Short duration pulse test used to minimize self-heating effect.

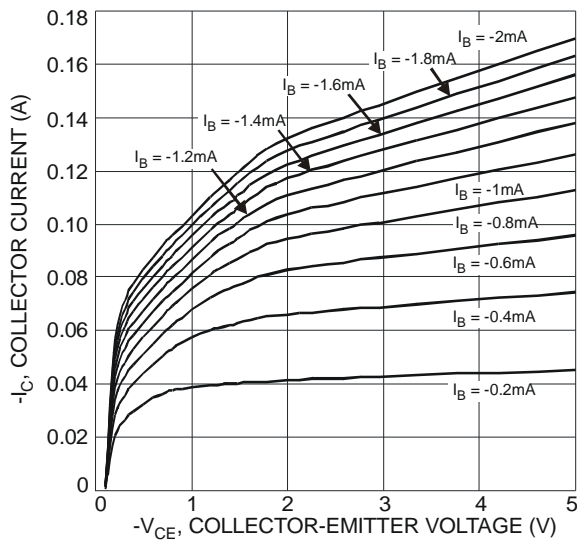

Fig. 4 Typical Collector Current vs. Collector-Emitter Voltage

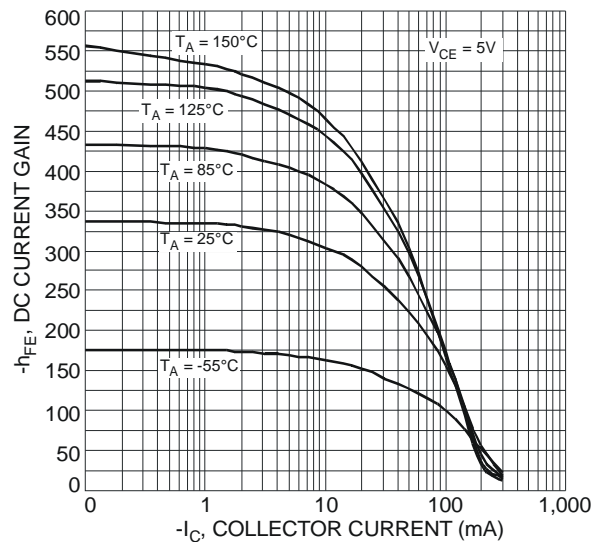

Fig. 5 Typical DC Current Gain vs. Collector Current

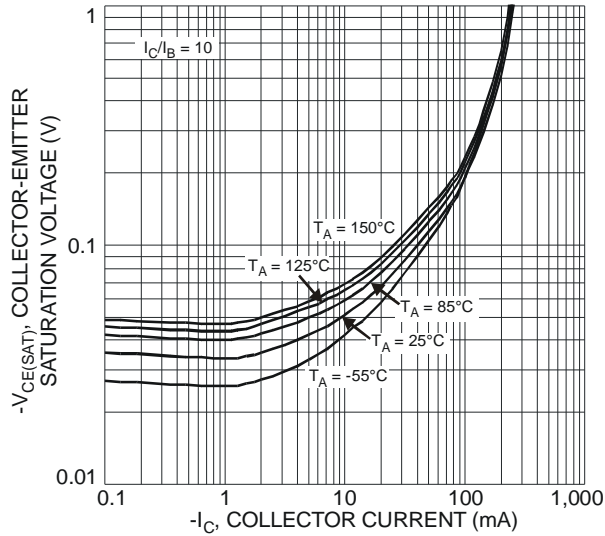

Fig. 6 Typical Collector-Emitter Saturation Voltage vs. Collector Current

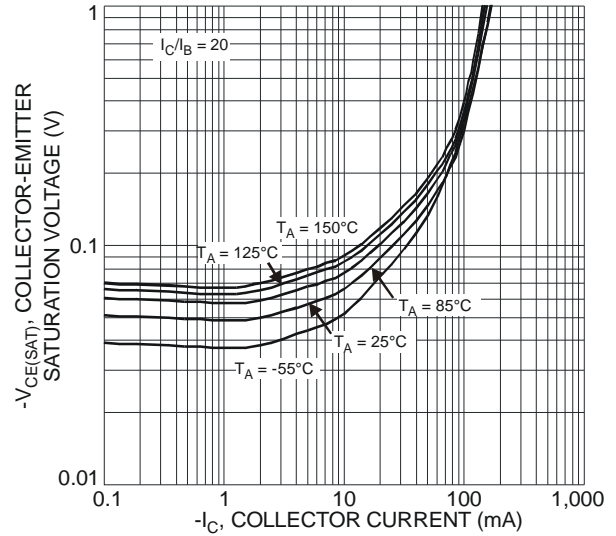

Fig. 7 Typical Collector-Emitter Saturation Voltage vs. Collector Current

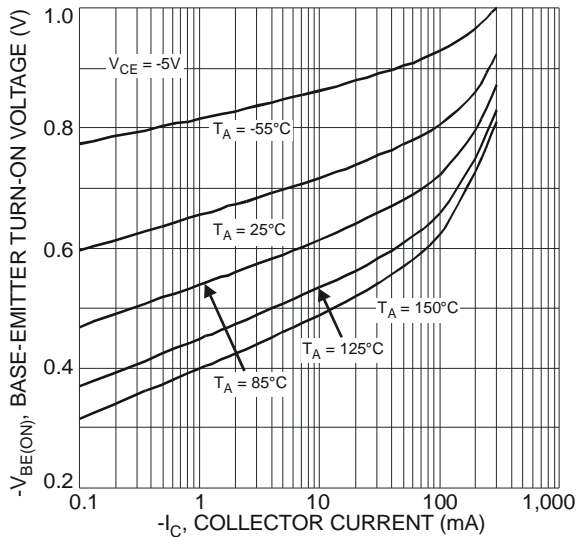

Fig. 8 Typical Base-Emitter Turn-On Voltage vs. Collector Current

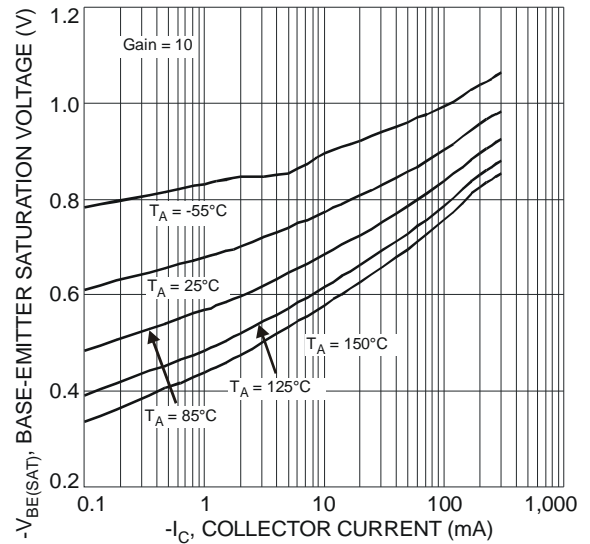
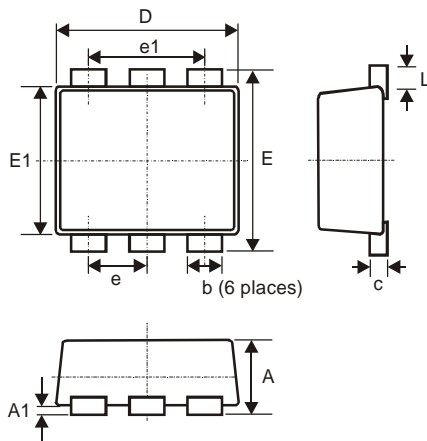

Fig. 9 Typical Base-Emitter Saturation Voltage vs. Collector Current

Package Outline Dimensions



SOT-963			
Dim	Min	Max	Typ
A	0.40	0.50	0.45
A1	0	0.05	-
C	0.120	0.180	0.150
D	0.95	1.05	1.00
E	0.95	1.05	1.00
E1	0.75	0.85	0.80
L	0.05	0.15	0.10
b	0.10	0.20	0.15
e	0.35 Typ		
e1	0.70 Typ		
All Dimensions in mm			

Suggest Pad Layout

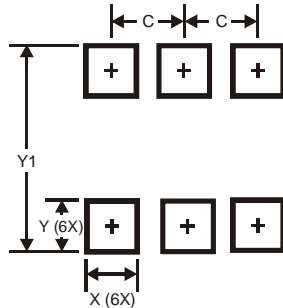

Dimensions	Value (in mm)
C	0.350
X	0.200
Y	0.200
Y1	1.100

IMPORTANT NOTICE

DIODES INCORPORATED MAKES NO WARRANTY OF ANY KIND, EXPRESS OR IMPLIED, WITH REGARDING TO THIS DOCUMENT, INCLUDING, BUT NOT LIMITED TO, THE IMPLIED WARRANTIES OF MERCHANTABILITY AND FITNESS FOR A PARTICULAR PURPOSE (AND THEIR EQUIVALENTS UNDER THE LAWS OF ANY JURISDICTION).

Diodes Incorporated and its subsidiaries reserve the right to make modifications, enhancements, improvements, corrections or other changes without further notice to this document and any product described herein. Diodes Incorporated does not assume any liability arising out of the application or use of this document or any product described herein; neither does Diodes Incorporated convey any license under its patent or trademark rights, nor the rights of others. Any Customer or user of this document or products described herein in such applications shall assume all risks of such use and will agree to hold Diodes Incorporated and all the companies whose products are represented on Diodes Incorporated website, harmless against all damages.

Diodes Incorporated does not warrant or accept any liability whatsoever in respect of any products purchased through unauthorized sales channel. Should Customers purchase or use Diodes Incorporated products for any unintended or unauthorized application, Customers shall indemnify and hold Diodes Incorporated and its representatives harmless against all claims, damages, expenses, and attorney fees arising out of, directly or indirectly, any claim of personal injury or death associated with such unintended or unauthorized application.

Products described herein may be covered by one or more United States, international or foreign patents pending. Product names and markings noted herein may also be covered by one or more United States, international or foreign trademarks.

LIFE SUPPORT

Diodes Incorporated products are specifically not authorized for use as critical components in life support devices or systems without the express written approval of the Chief Executive Officer of Diodes Incorporated. As used herein:

A. Life support devices or systems are devices or systems which:

1. are intended to implant into the body, or
2. support or sustain life and whose failure to perform when properly used in accordance with instructions for use provided in the labeling can be reasonably expected to result in significant injury to the user.

B. A critical component is any component in a life support device or system whose failure to perform can be reasonably expected to cause the failure of the life support device or to affect its safety or effectiveness.

Customers represent that they have all necessary expertise in the safety and regulatory ramifications of their life support devices or systems, and acknowledge and agree that they are solely responsible for all legal, regulatory and safety-related requirements concerning their products and any use of Diodes Incorporated products in such safety-critical, life support devices or systems, notwithstanding any devices- or systems-related information or support that may be provided by Diodes Incorporated. Further, Customers must fully indemnify Diodes Incorporated and its representatives against any damages arising out of the use of Diodes Incorporated products in such safety-critical, life support devices or systems.

Copyright © 2009, Diodes Incorporated

www.diodes.com