

# General purpose transistor (dual transistors)

## UMZ1N / IMZ1A

●Features

- 1) Both a 2SA1037AK chip and 2SC241ZK chip in a UMT or SMT package.
- 2) Mounting possible with UMT3 or SMT3 automatic mounting machines.
- 3) Transistor elements are independent, eliminating interference.
- 4) Mounting cost and area can be cut in half.

●Structure

NPN/PNP epitaxial planar silicon transistor

●External dimensions (Units: mm)

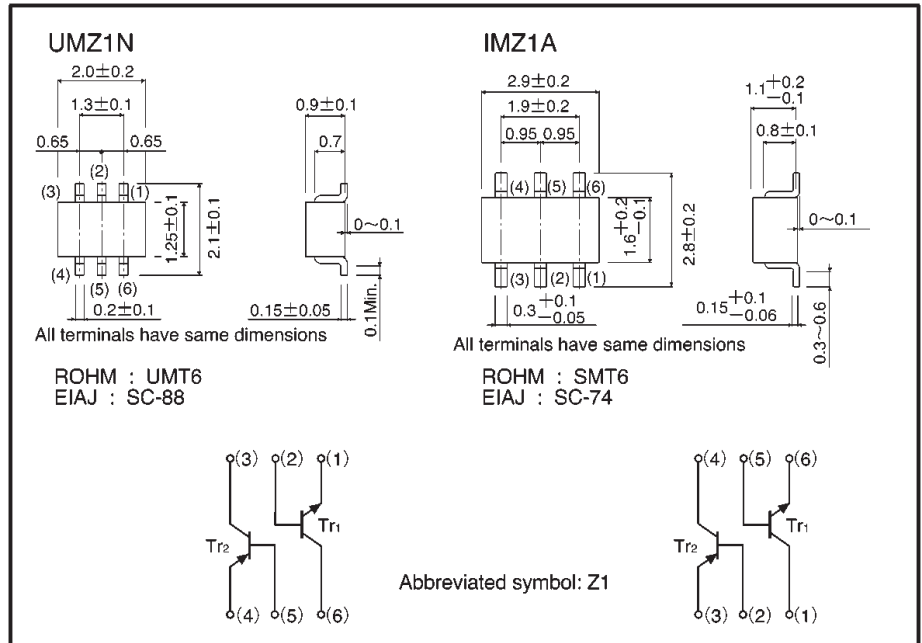

●Absolute maximum ratings (Ta = 25°C)

Parameter	Symbol	Limits		Unit
		Tr <sub>1</sub>	Tr <sub>2</sub>	
Collector-base voltage	V <sub>CB0</sub>	60	-60	V
Collector-emitter voltage	V <sub>CEO</sub>	50	-50	V
Emitter-base voltage	V <sub>EBO</sub>	7	-6	V
Collector current	I <sub>c</sub>	150	-150	mA
Collector power dissipation	UMZ1N	150 (TOTAL)		mW
	IMZ1A	300 (TOTAL)		
Junction temperature	T <sub>j</sub>	150		°C
Storage temperature	T <sub>stg</sub>	-55~+150		°C

\*1 120mW per element must not be exceeded.

\*2 200mW per element must not be exceeded.

## ●Electrical characteristics (Ta = 25°C)

## Tr1 (NPN)

Parameter	Symbol	Min.	Typ.	Max.	Unit	Conditions
Collector-base breakdown voltage	BV <sub>CB0</sub>	60	—	—	V	I <sub>C</sub> =50 μA
Collector-emitter breakdown voltage	BV <sub>CEO</sub>	50	—	—	V	I <sub>C</sub> =1mA
Emitter-base breakdown voltage	BV <sub>EBO</sub>	7	—	—	V	I <sub>E</sub> =50 μA
Collector cutoff current	I <sub>CB0</sub>	—	—	0.1	μA	V <sub>CB</sub> =60V
Emitter cutoff current	I <sub>EBO</sub>	—	—	0.1	μA	V <sub>EB</sub> =7V
Collector-emitter saturation voltage	V <sub>CE(sat)</sub>	—	—	0.4	V	I <sub>C</sub> /I <sub>B</sub> =50mA/5mA
DC current transfer ratio	h <sub>FE</sub>	120	—	560	—	V <sub>CE</sub> /I <sub>C</sub> =6V/1mA
Transition frequency	f <sub>T</sub>	—	180	—	MHz	V <sub>CE</sub> =12V, I <sub>C</sub> =-2mA, f=100MHz
Output capacitance	C <sub>ob</sub>	—	2	3.5	pF	V <sub>CB</sub> =12V, I <sub>E</sub> =0A, f=1MHz

## Tr2 (PNP)

Parameter	Symbol	Min.	Typ.	Max.	Unit	Conditions
Collector-base breakdown voltage	BV <sub>CB0</sub>	-60	—	—	V	I <sub>C</sub> =-50 μA
Collector-emitter breakdown voltage	BV <sub>CEO</sub>	-50	—	—	V	I <sub>C</sub> =-1mA
Emitter-base breakdown voltage	BV <sub>EBO</sub>	-6	—	—	V	I <sub>E</sub> =-50 μA
Collector cutoff current	I <sub>CB0</sub>	—	—	-0.1	μA	V <sub>CB</sub> =-60V
Emitter cutoff current	I <sub>EBO</sub>	—	—	-0.1	μA	V <sub>EB</sub> =-6V
Collector-emitter saturation voltage	V <sub>CE(sat)</sub>	—	—	-0.5	V	I <sub>C</sub> /I <sub>B</sub> =-50mA/-5mA
DC current transfer ratio	h <sub>FE</sub>	120	—	560	—	V <sub>CE</sub> /I <sub>C</sub> =-6V/-1mA
Transition frequency	f <sub>T</sub>	—	140	—	MHz	V <sub>CE</sub> =-12V, I <sub>C</sub> =2mA, f=100MHz
Output capacitance	C <sub>ob</sub>	—	4	5	pF	V <sub>CB</sub> =-12V, I <sub>E</sub> =0A, f=1MHz

## ●Packaging specifications

Part No.	Packaging type	Taping	
	Code	TR	T108
	Basic ordering unit (pieces)	3000	3000
UMZ1N		○	—
IMZ1A		—	○

●Electrical characteristic curves

Tr<sub>1</sub> (NPN)

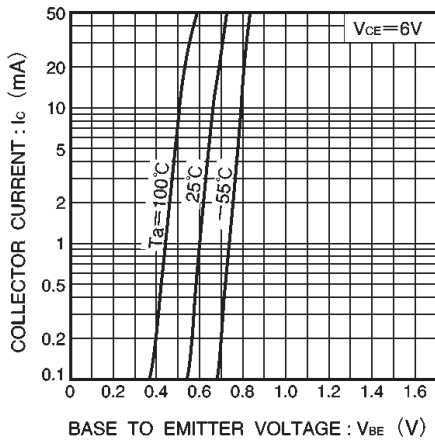

Fig.1 Grounded emitter propagation characteristics

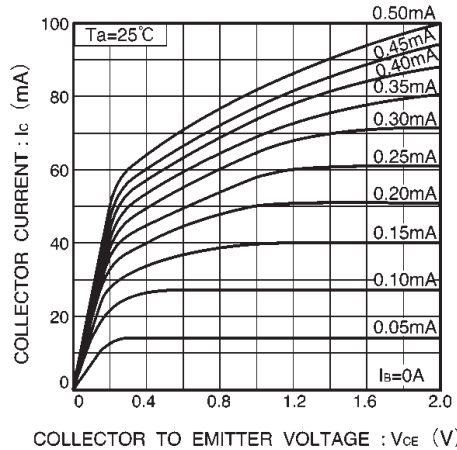

Fig.2 Grounded emitter output characteristics (I)

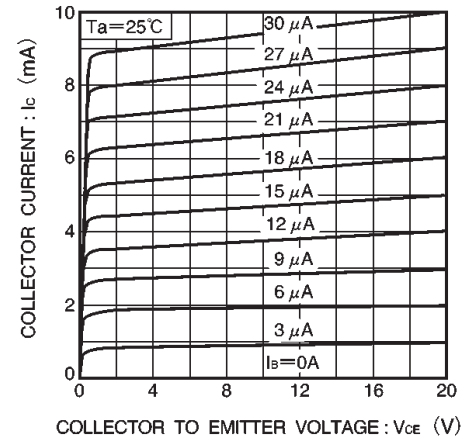

Fig.3 Grounded emitter output characteristics (II)

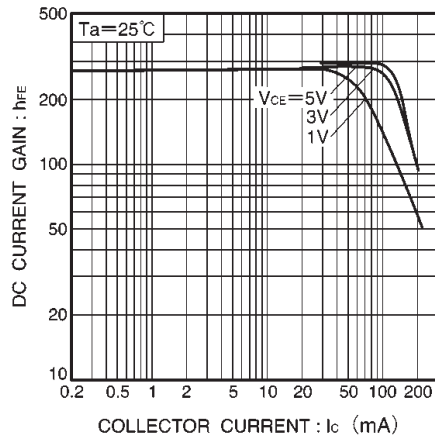

Fig.4 DC current gain vs. collector current (I)

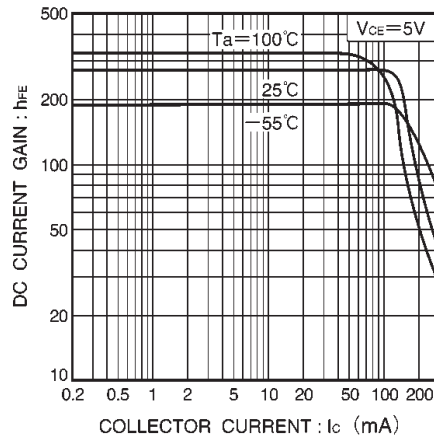

Fig.5 DC current gain vs. collector current (II)

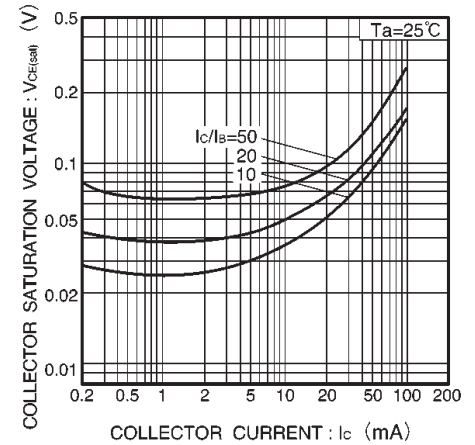

Fig.6 Collector-emitter saturation voltage vs. collector current (I)

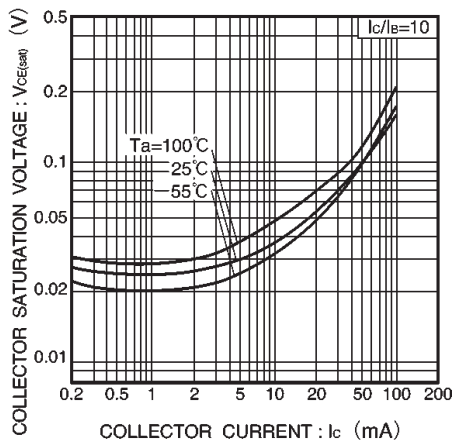

Fig.7 Collector-emitter saturation voltage vs. collector current (II)

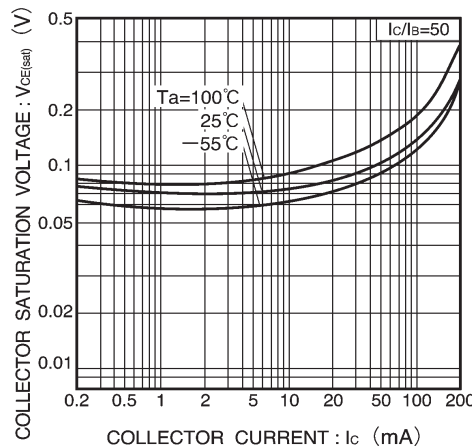

Fig.8 Collector-emitter saturation voltage vs. collector current (III)

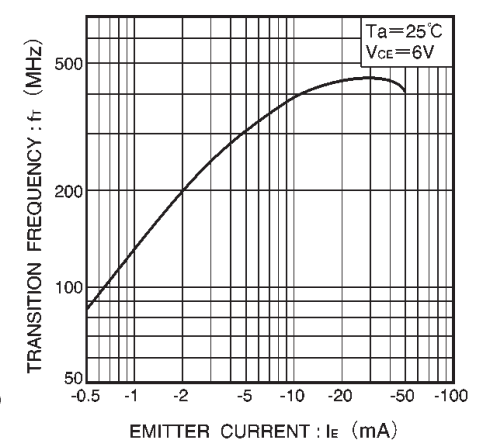

Fig.9 Gain bandwidth product vs. emitter current

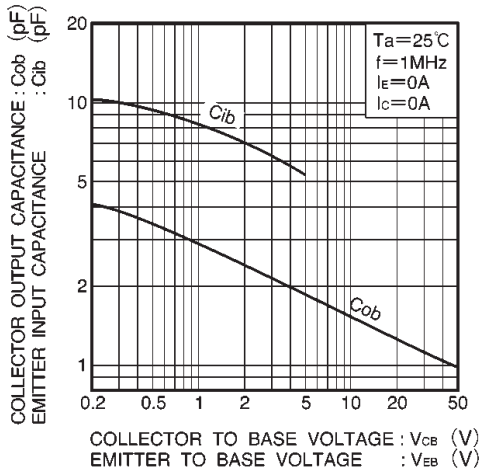

Fig.10 Collector output capacitance vs. collector-base voltage  
Emitter input capacitance vs. emitter-base voltage

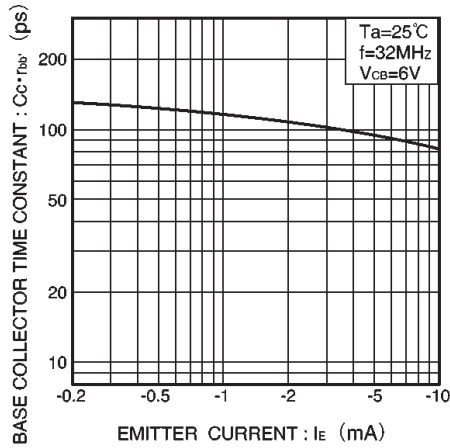

Fig.11 Base-collector time constant vs. emitter current

● Electrical characteristic curves

Tr<sub>2</sub> (PNP)

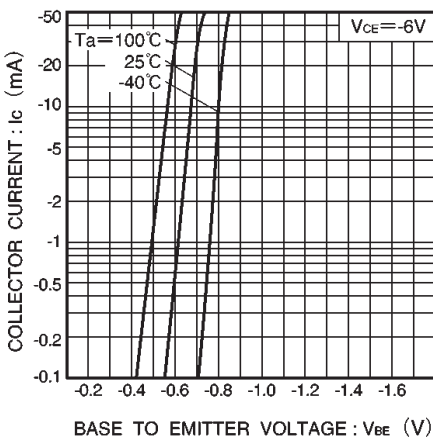

Fig.12 Grounded emitter propagation characteristics

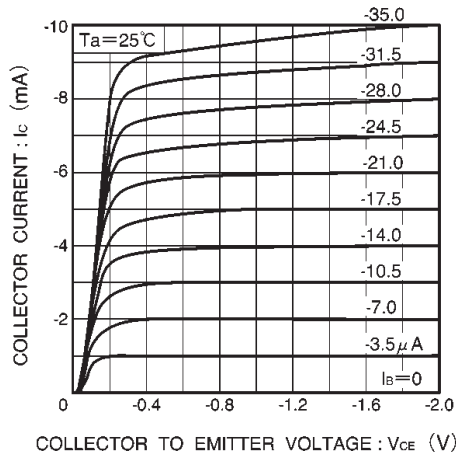

Fig.13 Grounded emitter output characteristics (I)

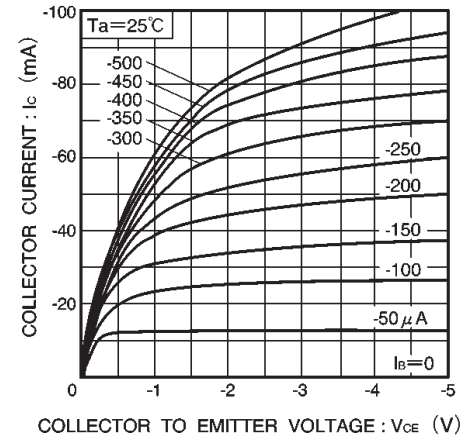

Fig.14 Grounded emitter output characteristics (II)

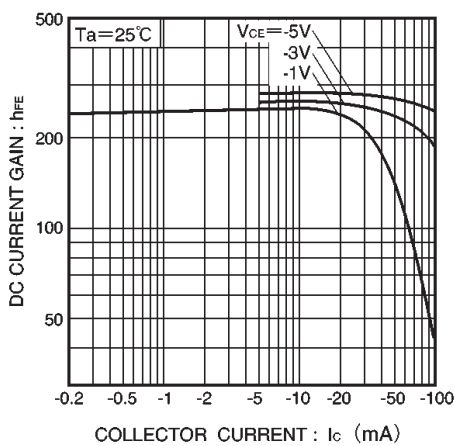

Fig.15 DC current gain vs. collector current (I)

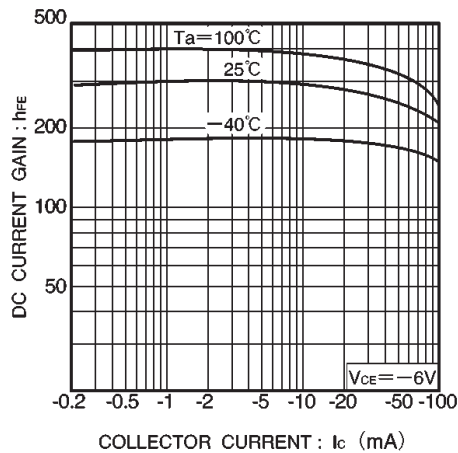

Fig.16 DC current gain vs. collector current (II)

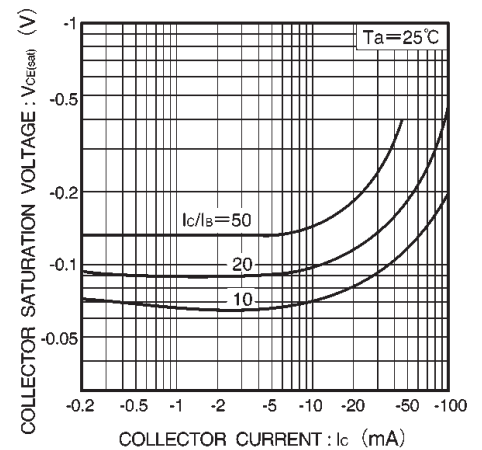

Fig.17 Collector-emitter saturation voltage vs. collector current (I)

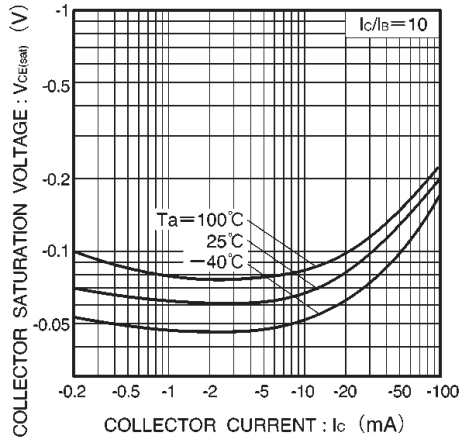

Fig.18 Collector-emitter saturation voltage vs. collector current ( I )

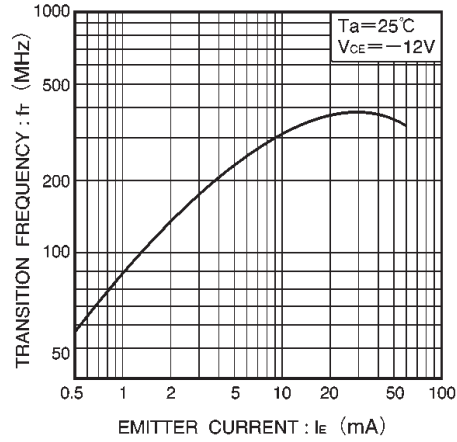

Fig.19 Gain bandwidth product vs. emitter current

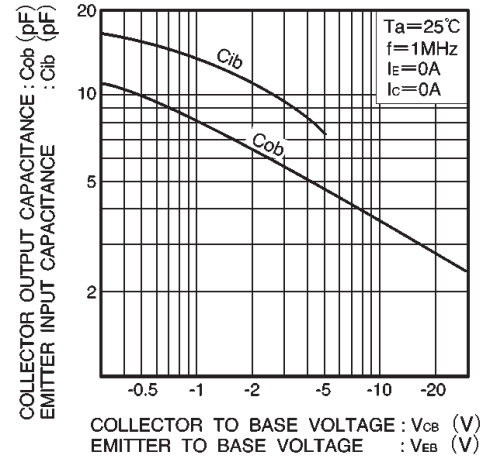

Fig.20 Collector output capacitance vs. collector-base voltage  
Emitter input capacitance vs. emitter-base voltage