



LBN08012 SAW Filter Electrical Characteristic

Specifications

Parameter	Unit	Minimum	Typical	Maximum
Center Frequency	MHz	79.875	80	80.125
Insertion Loss	dB		27.4	28
1.5 dB Bandwidth	MHz	15.1	15.17	
18 dB Bandwidth	MHz		15.84	15.9
25 dB Bandwidth	MHz		15.97	16.0
30 dB Bandwidth	MHz		16.04	16.5
40 dB Bandwidth	MHz		16.15	18.5
Passband variation	dB		1.0	1.5
Absolute Delay	usec		2.60	2.75
Ultimate Rejection	dB	40	55	
Substrate Material		YZ LN		
Ambient Temperature	°C	25		
Package Size	DIP3512 (35.0x12.7x5.2mm ³)			

Typical Performance

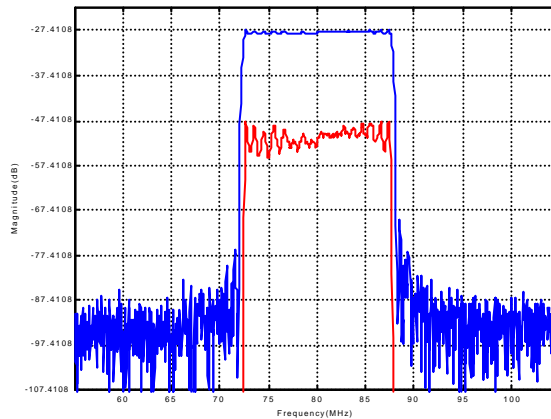

Package Outline

Matching Configuration

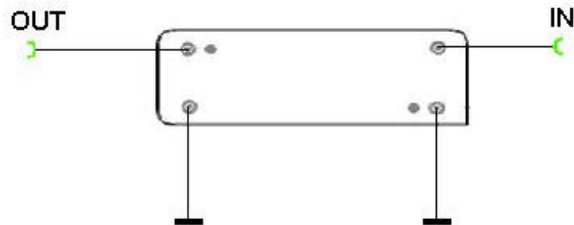
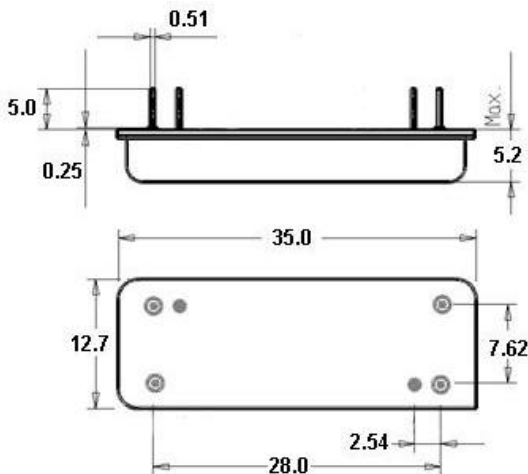

Source/Load Impedance = 50 ohm