

Specifications

Parameter	Unit	Minimum	Typical	Maximum
Center Frequency	MHz	69.95	70	70.05
Insertion Loss	dB	-	23.5	24.5
2 dB Bandwidth	MHz	6	6.02	-
35 dB Bandwidth	MHz	-	6.71	6.8
40 dB Bandwidth	MHz	-	6.75	7.2
45 dB Bandwidth	MHz	-	6.79	8
Passband Variation	dB	-	0.5	1.5
Absolute Delay	usec	-	3.94	4.1
Ultimate Rejection	dB	50	52	-
Substrate Material			-6.58	
Ambient Temperature	°C		25	
Package Size		DIP3512 (35.2x12.7x5.2mm ³)		

Notes:

1. All specifications are based on the test circuit shown
2. In production, devices will be tested at room temperature to a guardbanded specification to ensure electrical compliance over temperature
3. Electrical margin has been built into the design to account for the variations due to temperature drift and manufacturing tolerances
4. This is the optimum impedance in order to achieve the performance show

Matching Configuration

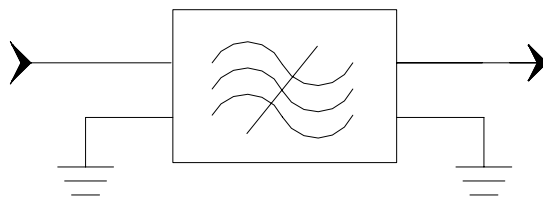

Source/Load Impedance=50 ohm

Notes - Component values may change depending
on board layout.

	SIPAT Co., Ltd. (CETC No. 26 Research Institute) Nanping Huayuan Road No. 14 Chongqing, China, 400060	Part Number	LBN07092	
		Rev. Date	2005-3-17	
		Rev.	1.0	Page 1/3

Package Dimension

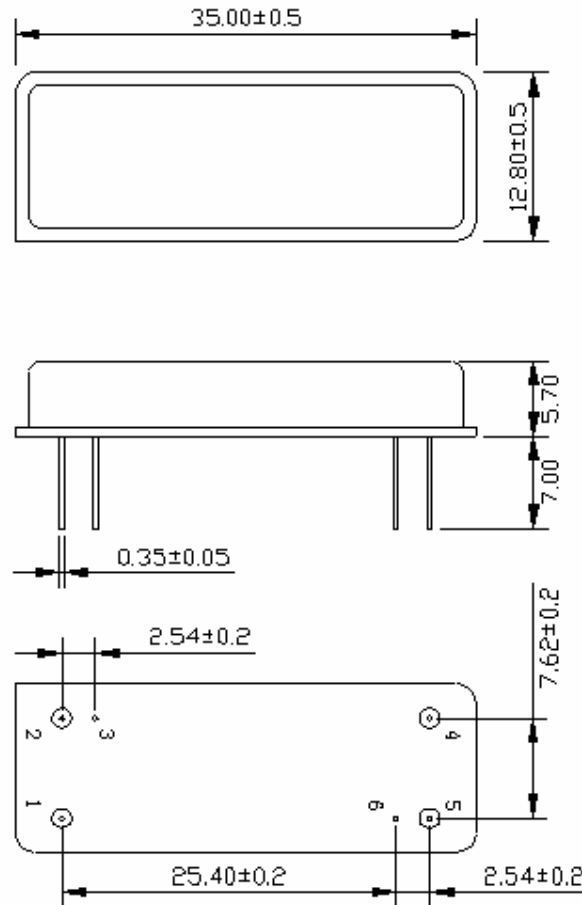

Input: 1
Output: 5

	SIPAT Co., Ltd. (CETC No. 26 Research Institute) Nanping Huayuan Road No. 14 Chongqing, China, 400060	Part Number	LBN07092	
		Rev. Date	2005-3-17	
		Rev.	1.0	Page

Typical Performance

Frequency Respond

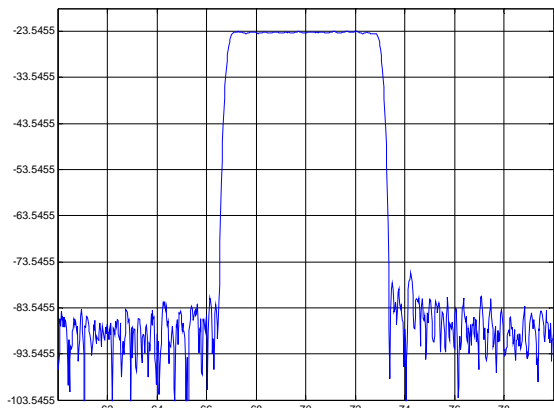

Passband Respond

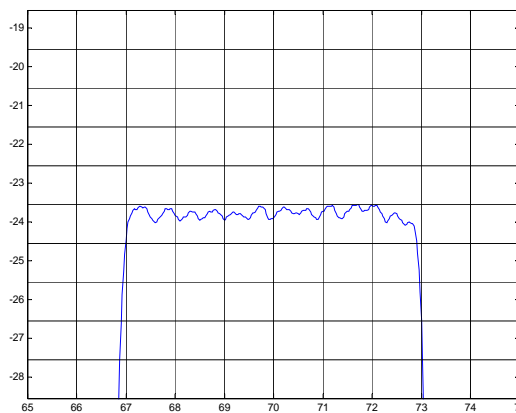

Group Delay Variation($f_0 \pm 2.5\text{MHz}$)

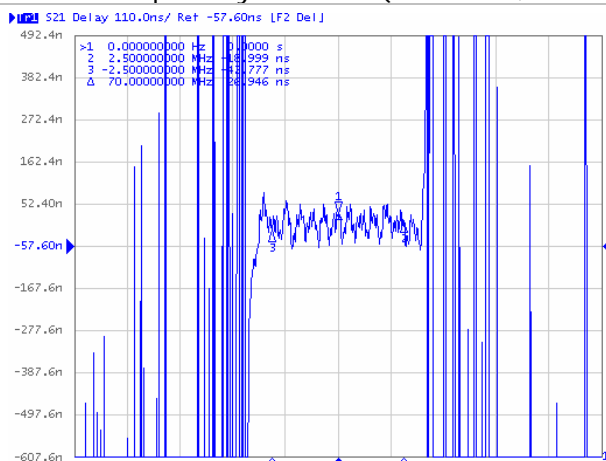

Phase Linearity($f_0 \pm 2.5\text{MHz}$)

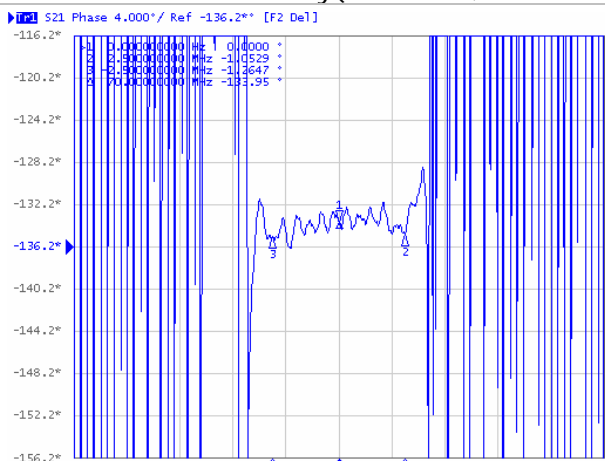

Smith Chart S11

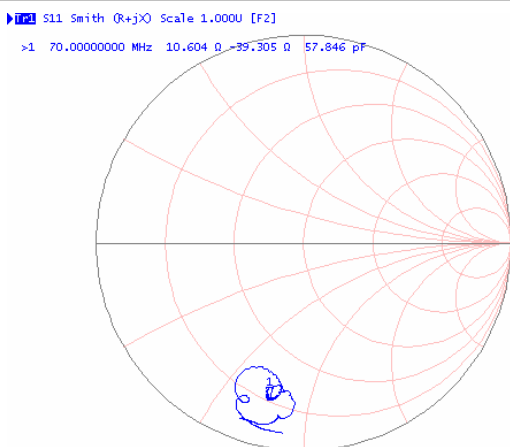

Smith Chart S22

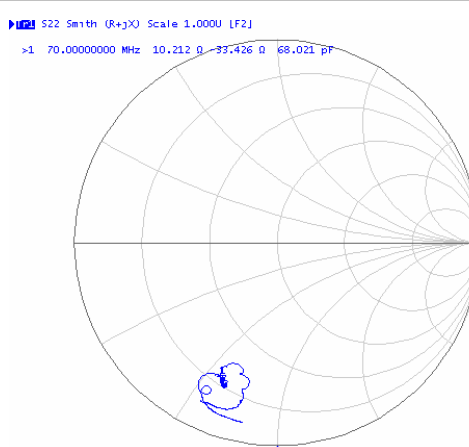

	SIPAT Co., Ltd. (CETC No. 26 Research Institute) Nanping Huayuan Road No. 14 Chongqing, China, 400060	Part Number	LBN07092	
		Rev. Date	2005-3-17	
		Rev.	1.0	Page 3/3