

2SC3940, 2SC3940A

Silicon NPN epitaxial planer type

For low-frequency output amplification and driver amplification

Complementary to 2SA1534 and 2SA1534A

■ Features

- Low collector to emitter saturation voltage $V_{CE(sat)}$.
- Allowing supply with the radial taping.

■ Absolute Maximum Ratings (Ta=25°C)

Parameter	Symbol	Ratings	Unit
Collector to base voltage	2SC3940	30	V
	2SC3940A	60	
Collector to emitter voltage	2SC3940	25	V
	2SC3940A	50	
Emitter to base voltage	V_{EBO}	5	V
Peak collector current	I_{CP}	1.5	A
Collector current	I_C	1	A
Collector power dissipation	P_C	1	W
Junction temperature	T_j	150	°C
Storage temperature	T_{stg}	-55 ~ +150	°C

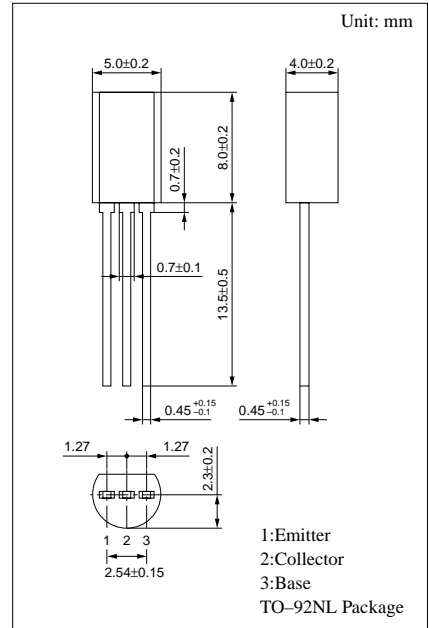

■ Electrical Characteristics (Ta=25°C)

Parameter	Symbol	Conditions	min	typ	max	Unit
Collector cutoff current	I_{CBO}	$V_{CB} = 20V, I_E = 0$			0.1	μA
Collector to base voltage	V_{CBO}	$I_C = 10\mu A, I_E = 0$	30			V
			60			
Collector to emitter voltage	V_{CEO}	$I_C = 2mA, I_B = 0$	25			V
			50			
Emitter to base voltage	V_{EBO}	$I_E = 10\mu A, I_C = 0$	5			V
Forward current transfer ratio	h_{FE1}^{*1}	$V_{CE} = 10V, I_C = 500mA^{*2}$	85		340	
	h_{FE2}	$V_{CE} = 5V, I_B = 1A^{*2}$	50			
Collector to emitter saturation voltage	$V_{CE(sat)}$	$I_C = 500mA, I_B = 50mA^{*2}$		0.2	0.4	V
Base to emitter saturation voltage	$V_{BE(sat)}$	$I_B = 500mA, I_a = 50mA^{*2}$		0.85	1.2	V
Transition frequency	f_T	$V_{CB} = 10V, I_E = -50mA, f = 200MHz$		200		MHz
Collector output capacitance	C_{ob}	$V_{CB} = 10V, I_E = 0, f = 1MHz$		11	20	pF

*2 Pulse measurement

*1 h_{FE1} Rank classification

Rank	Q	R	S
h_{FE1}	85 ~ 170	120 ~ 240	170 ~ 340

$P_C - T_a$

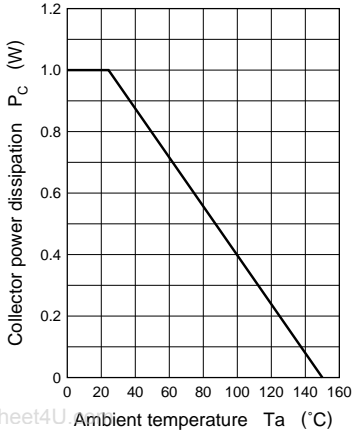

$I_C - V_{CE}$

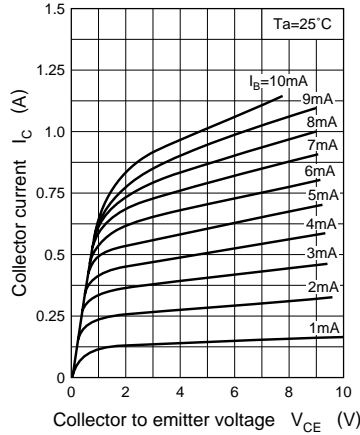

$I_C - I_B$

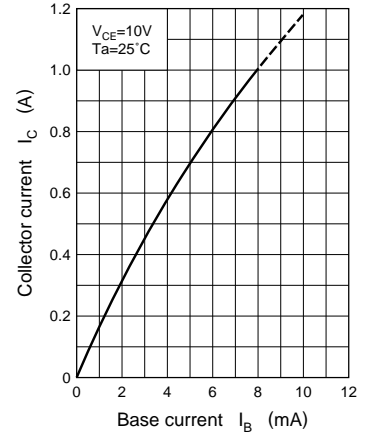

$V_{CE(sat)} - I_C$

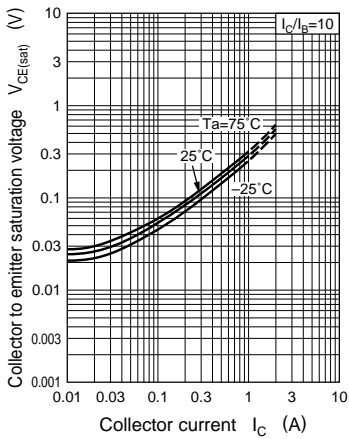

$V_{BE(sat)} - I_C$

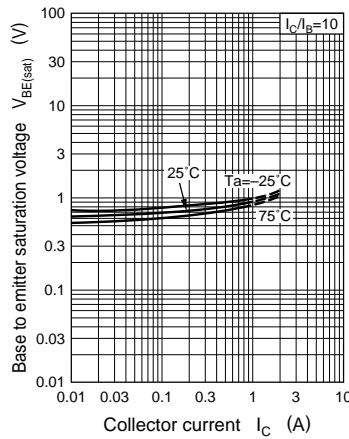

$h_{FE} - I_C$

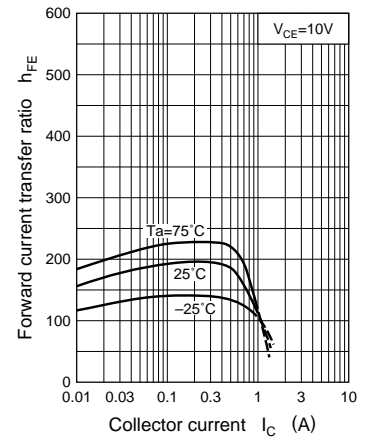

$f_T - I_E$

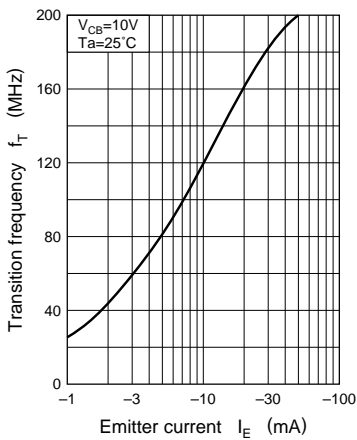

$C_{ob} - V_{CB}$

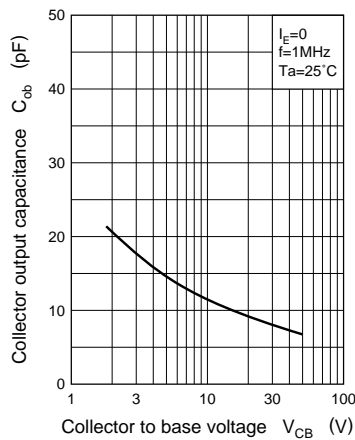

$V_{CER} - R_{BE}$

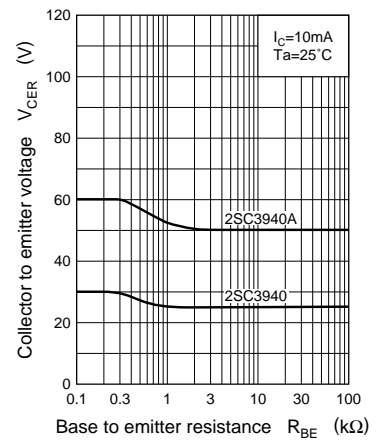

$I_{CEO} - T_a$

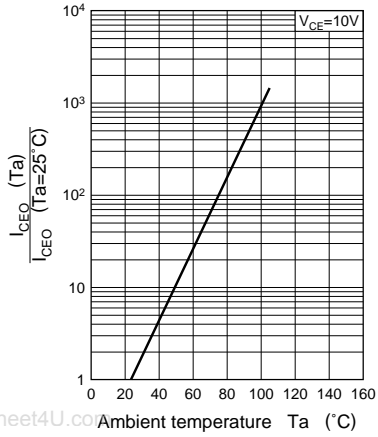

Area of safe operation (ASO)

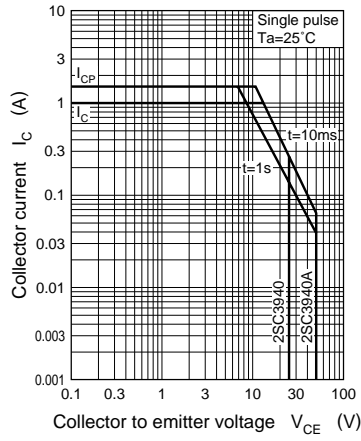

www.DataSheet4U.com