



500mA High Side (PNP) Driver with On-Chip Flyback Diode

Description

The CS8240 is a fast, PNP high side driver capable of delivering up to 500mA into a resistive or inductive load in harsh automotive or industrial environments. An internal flyback diode clamp is incorporated for inductive loads. The input (V_{IN}) is TTL and CMOS compatible and has hysteresis to minimize the effects of noise. When the input is high, the output is on. When the input is low, the output is off and the supply voltage quiescent current is

very low ($<1.0\mu A$, typ). For device protection, the CS8240 incorporates thermal shutdown, short circuit current limiting, over voltage shutdown, and reverse battery protection. The CS8240 can withstand supply voltage transients of 60V (min) and -50V.

The CS8240 is available in an overmolded 5 lead TO-220 package and is a competitive replacement for the LM-1921, LM-1951, LM-1952, MC-3399, and L-9350.

Absolute Maximum Ratings

Supply Voltage.....	6V to +26V
Overvoltage Protection.....	60V
Reverse Voltage.....	-16V DC
.....	-50V Transient
Internal Power Dissipation.....	Internally limited
Logic Input Voltage.....	-0.3V to 7.0V
Junction Temperature Range.....	-40°C to +150°C
Storage Temperature Range.....	-55°C to +165°C
Lead Temperature Soldering	
Wave Solder(through hole styles only).....	10 sec. max, 260°C peak
Electrostatic Discharge (Human Body Model).....	2kV

Block Diagram

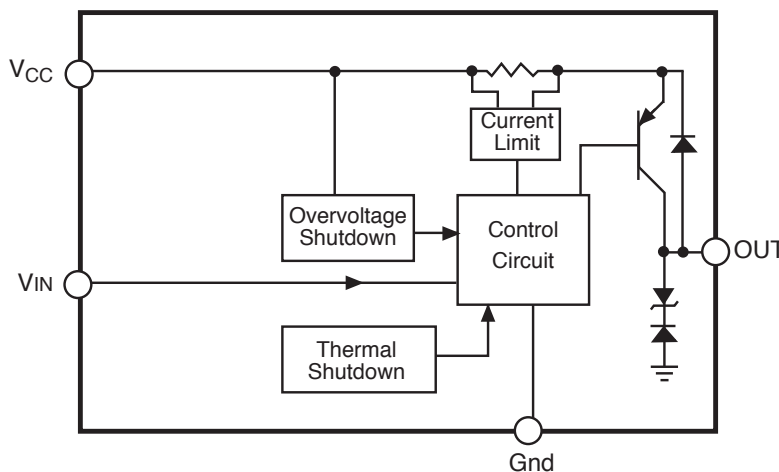

Features

- Low Output Saturation Voltage
 - 0.22V at $I_{OUT} = 125mA$
 - 0.33V at $I_{OUT} = 225mA$
- Overmolded Package
- On-Chip Flyback Diode
- Fault Protection
 - Over voltage Shutdown (32V, typ)
 - Thermal Shutdown (165°C, typ)
 - Short Circuit Limiting (1.1A typ)
 - 50V Reverse Transient Protection
 - 60V Load Dump Protection
 - Reverse Battery
- Low Quiescent Current (Off State)
- ESD Protected

Package Options

5 Lead TO-220 Overmolded

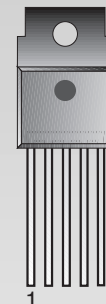

- 1 V_{CC}
- 2 OUT
- 3 NC
- 4 Gnd
- 5 V_{IN}



Electrical Characteristics: $-40^{\circ}\text{C} \leq T_A \leq 125^{\circ}\text{C}$, $-40^{\circ}\text{C} \leq T_J \leq 150^{\circ}\text{C}$, unless otherwise noted.

PARAMETER	TEST CONDITIONS	MIN	TYP	MAX	UNIT
■ General Characteristics					
Operating Supply Voltage		6.0			V
Quiescent Current	$V_{CC} = 12\text{V}$, $V_{IN} \leq V_{IN(Low)}$ $V_{IN} \geq V_{IN(HI)}$, $R_{LOAD} = 50\Omega$, $6 \leq V_{CC} \leq 20\text{V}$ $20\text{V} \leq V_{CC} \leq 24\text{V}$		1 16 25	100 30 50	μA mA mA
■ Output Stage					
Output Saturation Voltage	$V_{IN} \leq V_{IN(HI)}$, $V_{CC} = 6.0\text{V}$, $I_{LOAD} = 125\text{mA}$ $V_{CC} = 14\text{V}$, $I_{LOAD} = 225\text{mA}$		0.22 0.33	0.5 0.7	V V
Output Leakage Current	Input $\leq V_{IN(L)}$, $V_{CC} = 12\text{V}$, $V_{OUT} = 0\text{V}$		1	150	μA
Negative Output Clamp	$I_{CLAMP} = 100\text{mA}$, $V_{CC} = 12\text{V}$	-18	-15.5	-12	V
Turn On Delay Time	$V_{CC} = 12\text{V}$, $I_{LOAD} = 150\text{mA}$		5	20	us
Turn Off Delay Time	$V_{CC} = 12\text{V}$, $I_{LOAD} = 150\text{mA}$		5	20	us
■ Input Stage					
Input Voltage	Logic = High, $V_{CC} = 12\text{V}$ Turn ON Logic = Low, $V_{CC} = 12\text{V}$ Turn OFF	0.8	1.45 1.2	2.0	V V
Input Current	$V_{IN} = 5.5\text{V}$ $V_{IN} = 0.8\text{V}$		100 15	200 50	μA μA
■ Protection Circuitry					
Overvoltage Shutdown	$V_{IN} \geq V_{IN(HI)}$	26	32		V
Output Short Circuit Current	$V_{IN} \geq V_{IN(HI)}$, $V_{CC} = 12\text{V}$, $V_{OUT} = 0\text{V}$	0.55	1.1	2.5	A
Thermal Shutdown		150	165		$^{\circ}\text{C}$

Package Lead Description

PACKAGE LEAD #	LEAD SYMBOL	FUNCTION
5 Lead TO-220		
1	V_{CC}	Supply voltage to IC. Supplies load current through output PNP.
2	OUT	Collector of output PNP, current to load is sourced from this lead.
3	NC	No connection.
4	Gnd	Ground.
5	V_{IN}	Input voltage to control output. Logic high turns output on. Logic low turns output off.

Typical Performance Characteristics

CS8240

Quiescent Current vs. I_{OUT}

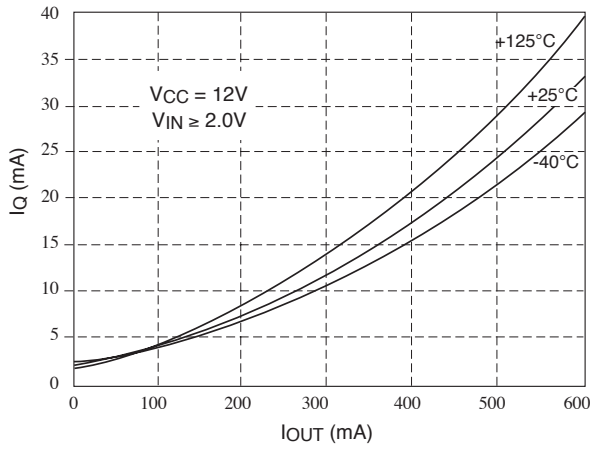

Output Saturation Voltage vs. I_{OUT}

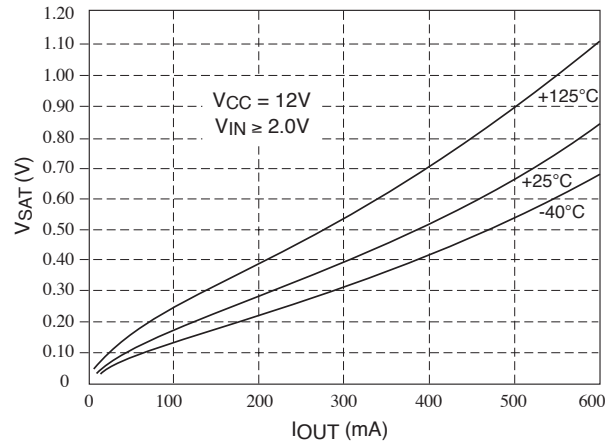

Turn-on Delay Time

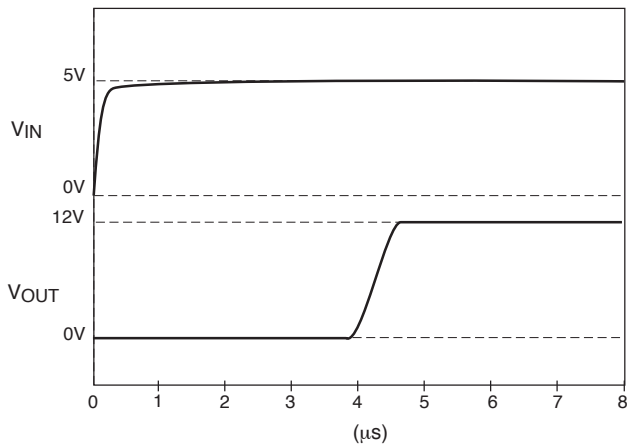

Flyback Clamp Characteristics

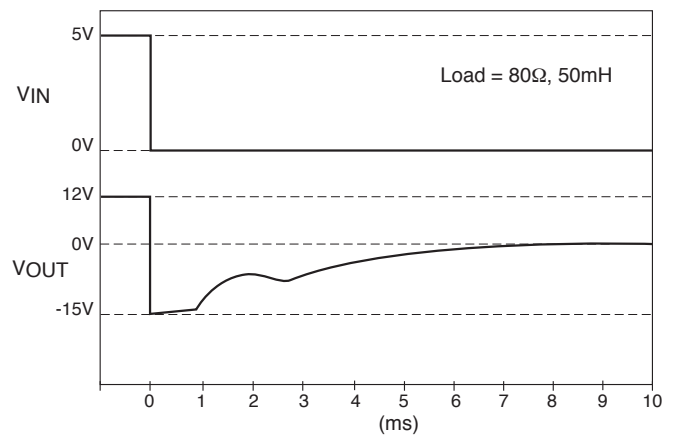

Turn Off Delay Time

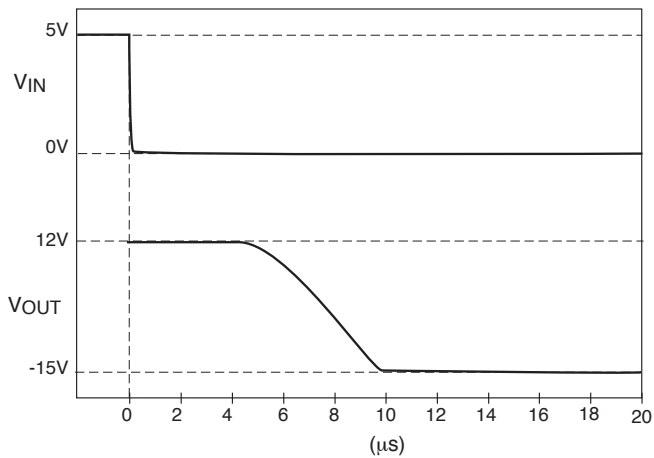

I_{IN} vs. V_{IN}

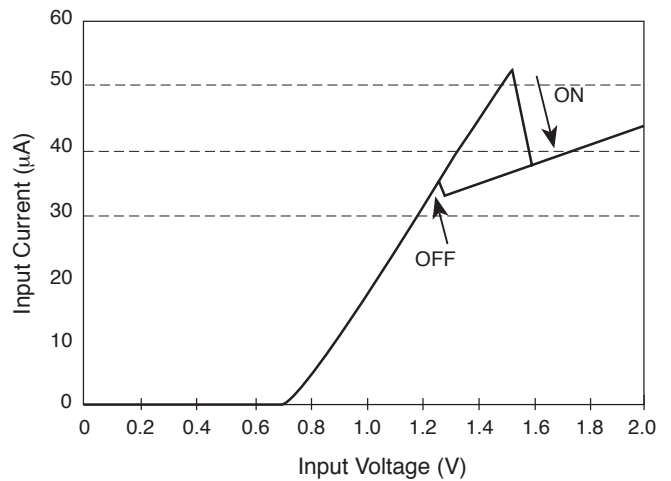

Input Stage

The input stage is a self biased band gap based circuit with a positive going trip point of 1.45V (typ) and a negative going trip point of 1.20V (typ) (250mV of hysteresis). When the input voltage is below the positive trip point, the quiescent current of the supply voltage line is less than 1 μ A, (typ). When the input voltage exceeds the positive trip point (1.45V, typ), the input stage "wakes up" the rest of the CS8240 circuitry and turns on the output stage.

Output Stage

The output stage is built around a high current PNP output transistor. A control amplifier monitors the saturation voltage of the output PNP and maintains a balance of low saturation voltage and minimum base drive to the PNP for the given out-

put current. The base drive of the PNP is the dominant component of the quiescent current of the CS8240 and is dependent on the level of output current.

Short circuit protection (1.1A, typ) is also incorporated in the output stage.

Protection Circuitry

In addition to the short circuit protection mentioned above, the CS8240 also incorporates a thermal shutdown circuit (165°C, typ) and a high voltage shutdown circuit (33V, typ), both of which cut off the drive to the PNP output transistor when excessive current is drawn. Inherent in the design of the CS8240 is transient protection to +60V and -50V on the supply line. The CS8240 is ESD protected in excess of 2kV (Human Body Model).

Typical Application Circuits

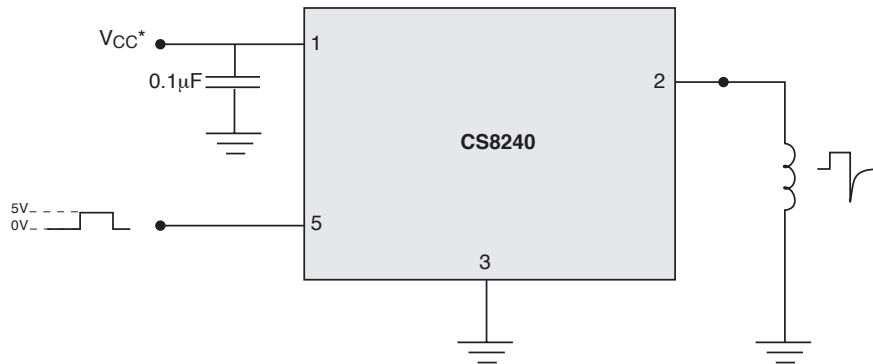
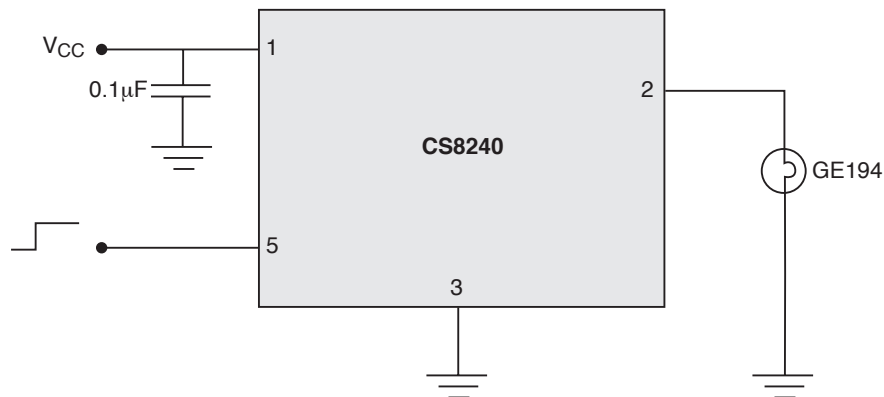
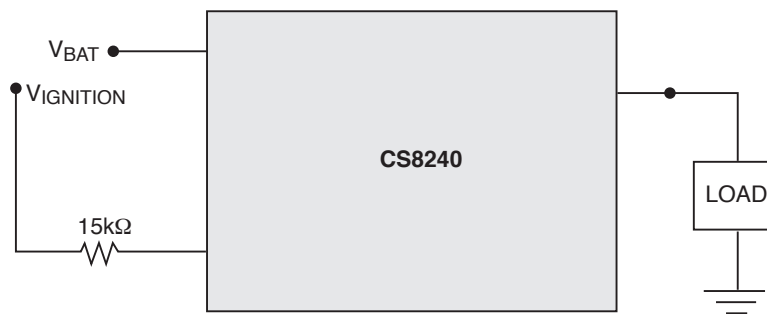
Solenoid Driver**Lamp Driver****Controlled High Side Switch**

Package Specification

CS8240

PACKAGE DIMENSIONS IN mm (INCHES)

PACKAGE THERMAL DATA

Thermal Data		5 Lead TO-220 (Overmolded)	
$R_{\theta JC}$	typ	4.0	$^{\circ}\text{C}/\text{W}$
$R_{\theta JA}$	typ	50	$^{\circ}\text{C}/\text{W}$

5 Lead Overmolded TO-220 (TFVA) Vertical

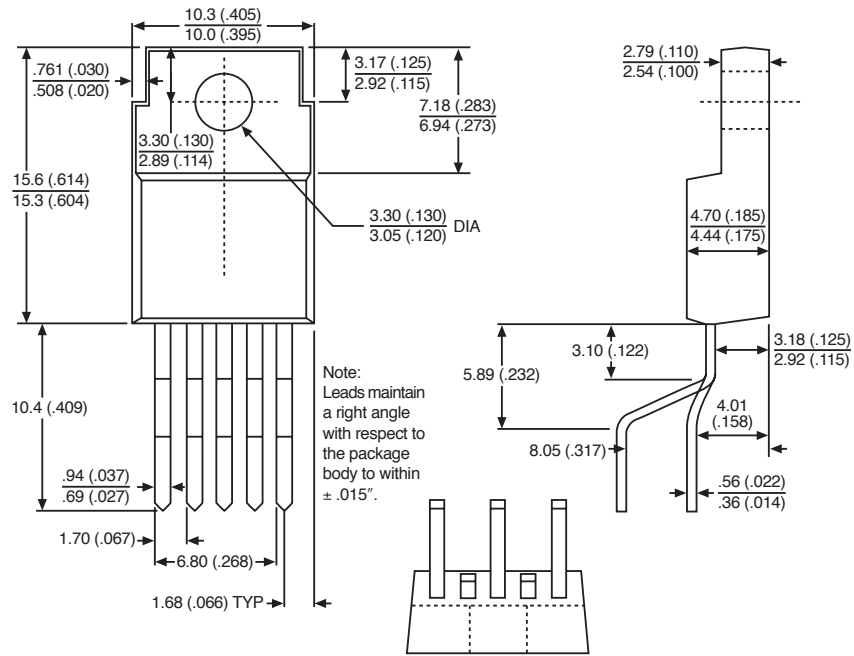

Ordering Information

Part Number	Description
CS8240YTFVA5	5 Lead Overmolded TO-220 Vertical

Cherry Semiconductor Corporation reserves the right to make changes to the specifications without notice. Please contact Cherry Semiconductor Corporation for the latest available information.