

DATA SHEET

BLT70 UHF power transistor

Product specification

1996 Feb 06

UHF power transistor

BLT70

FEATURES

- Very high efficiency
- Low supply voltage.

APPLICATIONS

- Hand-held radio equipment in common emitter class-AB operation in the 900 MHz communication band.

DESCRIPTION

NPN silicon planar epitaxial transistor encapsulated in a plastic SOT223H SMD package.

PINNING - SOT223H

PIN	SYMBOL	DESCRIPTION
1	e	emitter
2	b	base
3	e	emitter
4	c	collector

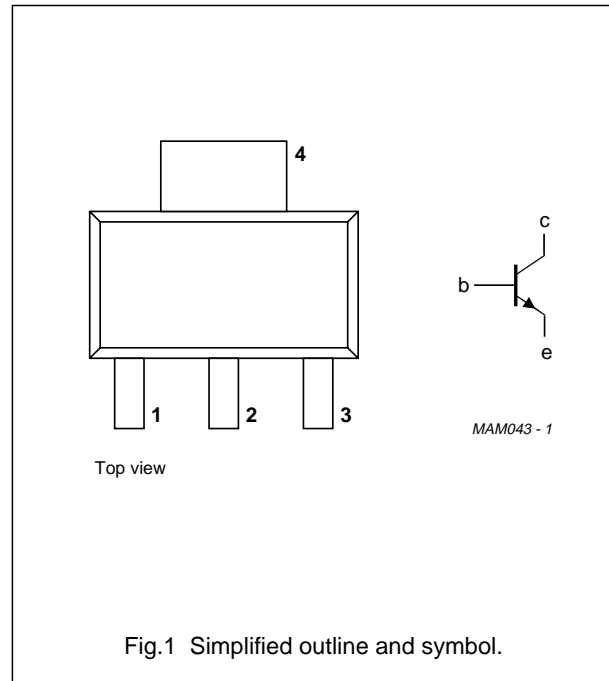

QUICK REFERENCE DATA

RF performance at $T_s \leq 60^\circ\text{C}$ in a common emitter test circuit (see Fig.7).

MODE OF OPERATION	f (MHz)	V_{CE} (V)	P_L (mW)	G_p (dB)	η_c (%)
CW, class-AB	900	4.8	600	≥ 6	≥ 60

UHF power transistor

BLT70

LIMITING VALUES

In accordance with the Absolute Maximum Rating System (IEC 134).

SYMBOL	PARAMETER	CONDITIONS	MIN.	MAX.	UNIT
V_{CBO}	collector-base voltage	open emitter	–	16	V
V_{CEO}	collector-emitter voltage	open base	–	8	V
V_{EBO}	emitter-base voltage	open collector	–	2.5	V
I_C	collector current (DC)		–	250	mA
P_{tot}	total power dissipation	$T_s = 60\text{ °C}$; note 1	–	2.1	W
T_{stg}	storage temperature		–65	+150	°C
T_j	operating junction temperature		–	175	°C

THERMAL CHARACTERISTICS

SYMBOL	PARAMETER	CONDITIONS	VALUE	UNIT
$R_{th\ j-s}$	thermal resistance from junction to soldering point	$P_{tot} = 2.1\text{ W}$; $T_s = 60\text{ °C}$; note 1	55	K/W

Note to the “Limiting values” and “Thermal characteristics”

- T_s is the temperature at the soldering point of the collector pin.

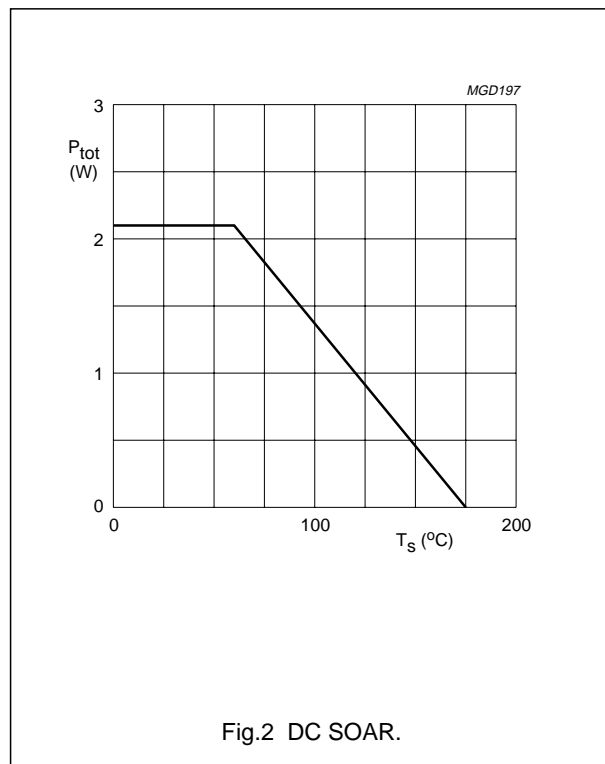

UHF power transistor

BLT70

CHARACTERISTICS

 $T_j = 25\text{ }^\circ\text{C}$ unless otherwise specified.

SYMBOL	PARAMETER	CONDITIONS	MIN.	MAX.	UNIT
$V_{(BR)CBO}$	collector-base breakdown voltage	open emitter; $I_C = 0.5\text{ mA}$	16	–	V
$V_{(BR)CEO}$	collector-emitter breakdown voltage	open base; $I_C = 5\text{ mA}$	8	–	V
$V_{(BR)EBO}$	emitter-base breakdown voltage	open collector; $I_E = 0.2\text{ mA}$	2.5	–	V
I_{CES}	collector leakage current	$V_{CE} = 7\text{ V}$; $V_{BE} = 0$	–	0.1	mA
h_{FE}	DC current gain	$V_{CE} = 4.8\text{ V}$; $I_C = 100\text{ mA}$	25	–	
C_C	collector capacitance	$V_{CB} = 4.8\text{ V}$; $I_E = i_e = 0$; $f = 1\text{ MHz}$	–	3.5	pF
C_{re}	feedback capacitance	$V_{CE} = 4.8\text{ V}$; $I_C = 0$; $f = 1\text{ MHz}$	–	2.5	pF

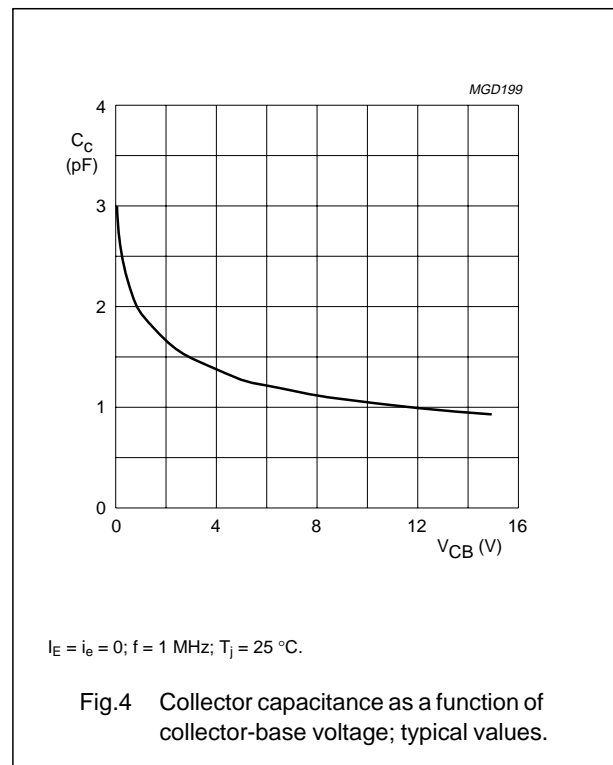
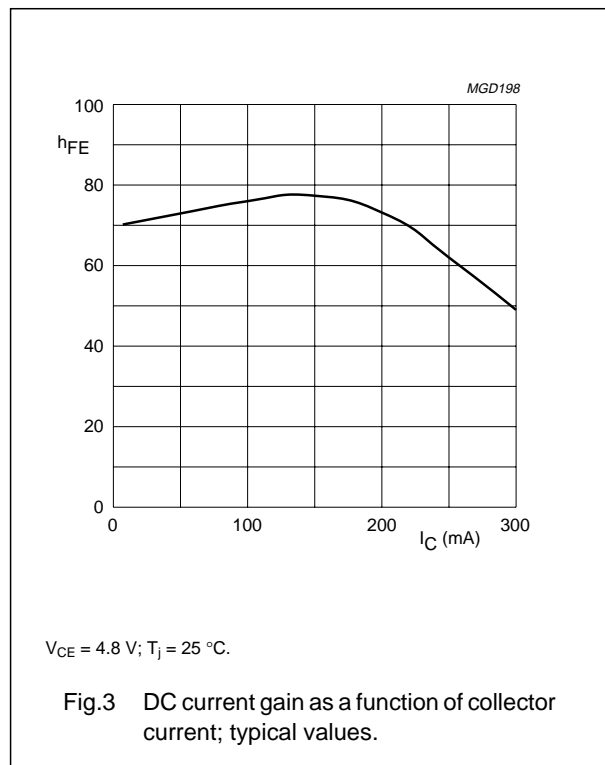

UHF power transistor

BLT70

APPLICATION INFORMATION

RF performance at $T_s \leq 60^\circ\text{C}$ in a common emitter test circuit (see note 1 and Fig.7).

MODE OF OPERATION	f (MHz)	V_{CE} (V)	I_{CQ} (mA)	P_L (W)	G_p (dB)	η_c (%)
CW, class-AB	900	4.8	0.01	0.6	≥ 6 typ. 8.1	≥ 60 typ. 73

Note

- T_s is the temperature at the soldering point of the collector pin.

Ruggedness in class-AB operation

The BLT70 is capable of withstanding a load mismatch corresponding to $V_{SWR} = 6 : 1$ through all phases under the following conditions: $f = 900\text{ MHz}$; $V_{CE} = 6.5\text{ V}$; $P_L = 0.5\text{ W}$; $T_s \leq 60^\circ\text{C}$.

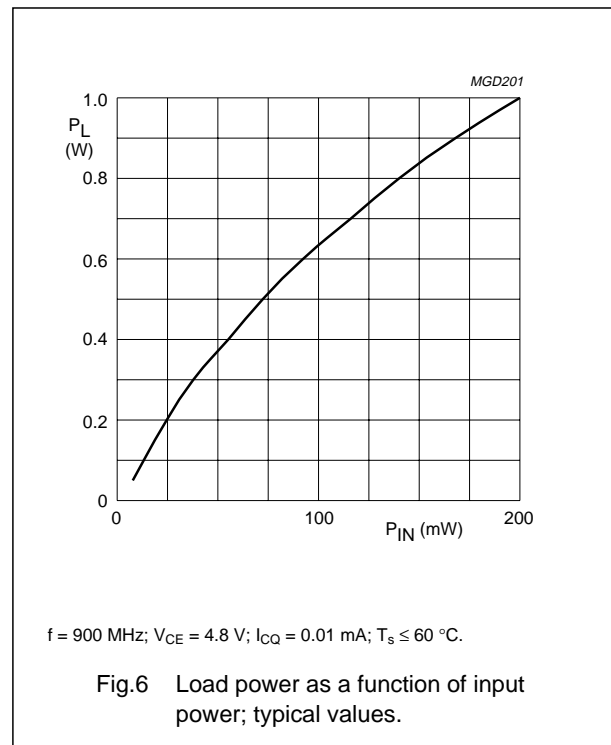
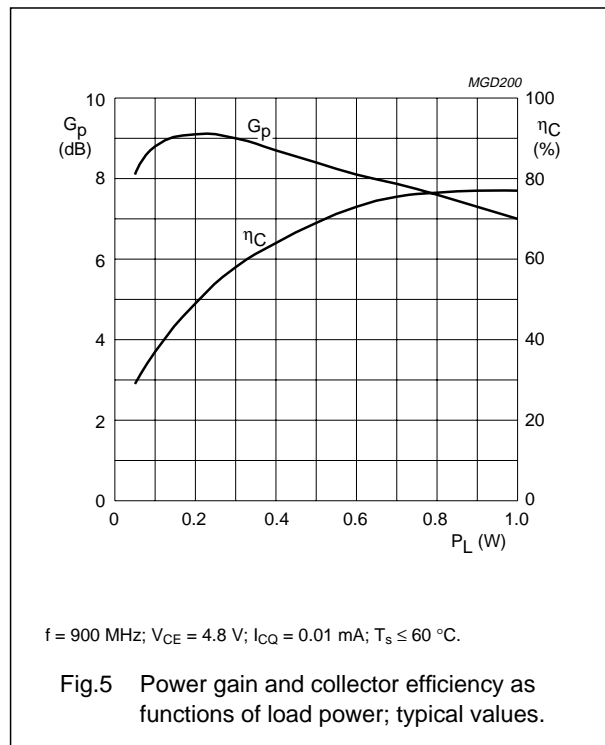

UHF power transistor

BLT70

Test circuit information

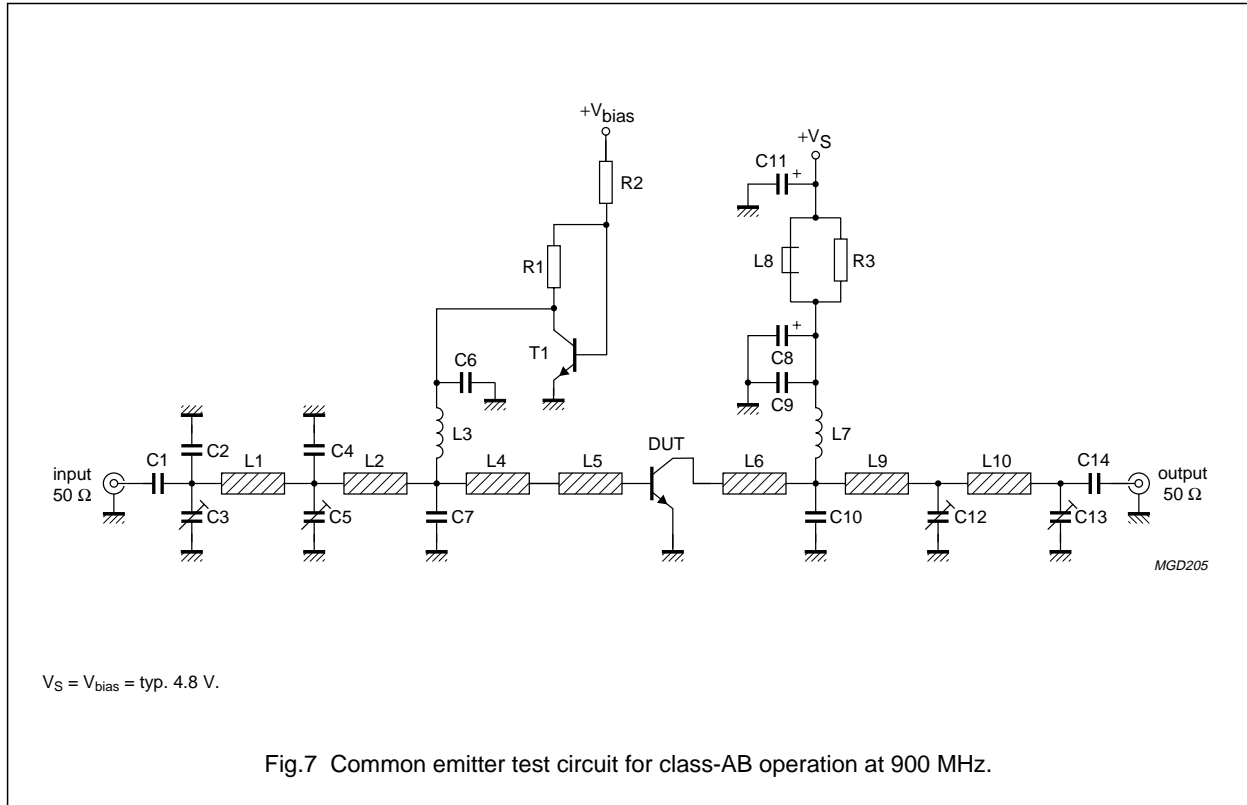

UHF power transistor

BLT70

List of components used in test circuit (see Figs 7 and 8)

COMPONENT	DESCRIPTION	VALUE	DIMENSIONS	CATALOGUE No.
C1, C6, C9, C14	multilayer ceramic chip capacitor; note 1	100 pF		
C2	multilayer ceramic chip capacitor; note 1	1 pF		
C4	multilayer ceramic chip capacitor; note 1	2.4 pF		
C3, C5, C12, C13	film dielectric trimmer	1.4 to 5.5 pF		2222 809 09004
C7	multilayer ceramic chip capacitor; note 1	5.1 pF		
C8	tantalum capacitor	1 μ F, 35 V		
C10	multilayer ceramic chip capacitor; note 1	2.7 pF		
C11	tantalum capacitor	100 μ F, 20 V		
L1	stripline; note 2	50 Ω	length 29.1 mm width 5 mm	
L2	stripline; note 2	50 Ω	length 21 mm width 5 mm	
L3	8 turns enamelled 0.8 mm copper wire	216 nH	length 7 mm internal dia. 4.5 mm	
L4	stripline; note 2	50 Ω	length 1 mm width 5 mm	
L5	stripline; note 2	50 Ω	length 3 mm width 2.5 mm	
L6	stripline; note 2	50 Ω	length 12 mm width 5 mm	
L7	8 turns enamelled 0.8 mm copper wire	105 nH	length 7 mm internal dia. 3.4 mm	
L8	grade 3B Ferroxcube wideband HF choke			4132 020 36640
L9	stripline; note 2	50 Ω	length 12 mm width 5 mm	
L10	stripline; note 2	50 Ω	length 28 mm width 5 mm	
R1	metal film resistor	0.1 W, 15 Ω		
R2	metal film resistor	0.1 W, 390 Ω		
R3	metal film resistor	0.6 W, 10 Ω		
T1	NPN transistor	BD139		

Notes

- American Technical Ceramics type 100A or capacitor of same quality.
- The striplines are on a double copper-clad printed-circuit board, with DUROID dielectric ($\epsilon_r = 2.2$); thickness $\frac{1}{16}$ " ; thickness of the copper sheet $2 \times 35 \mu\text{m}$.

UHF power transistor

BLT70

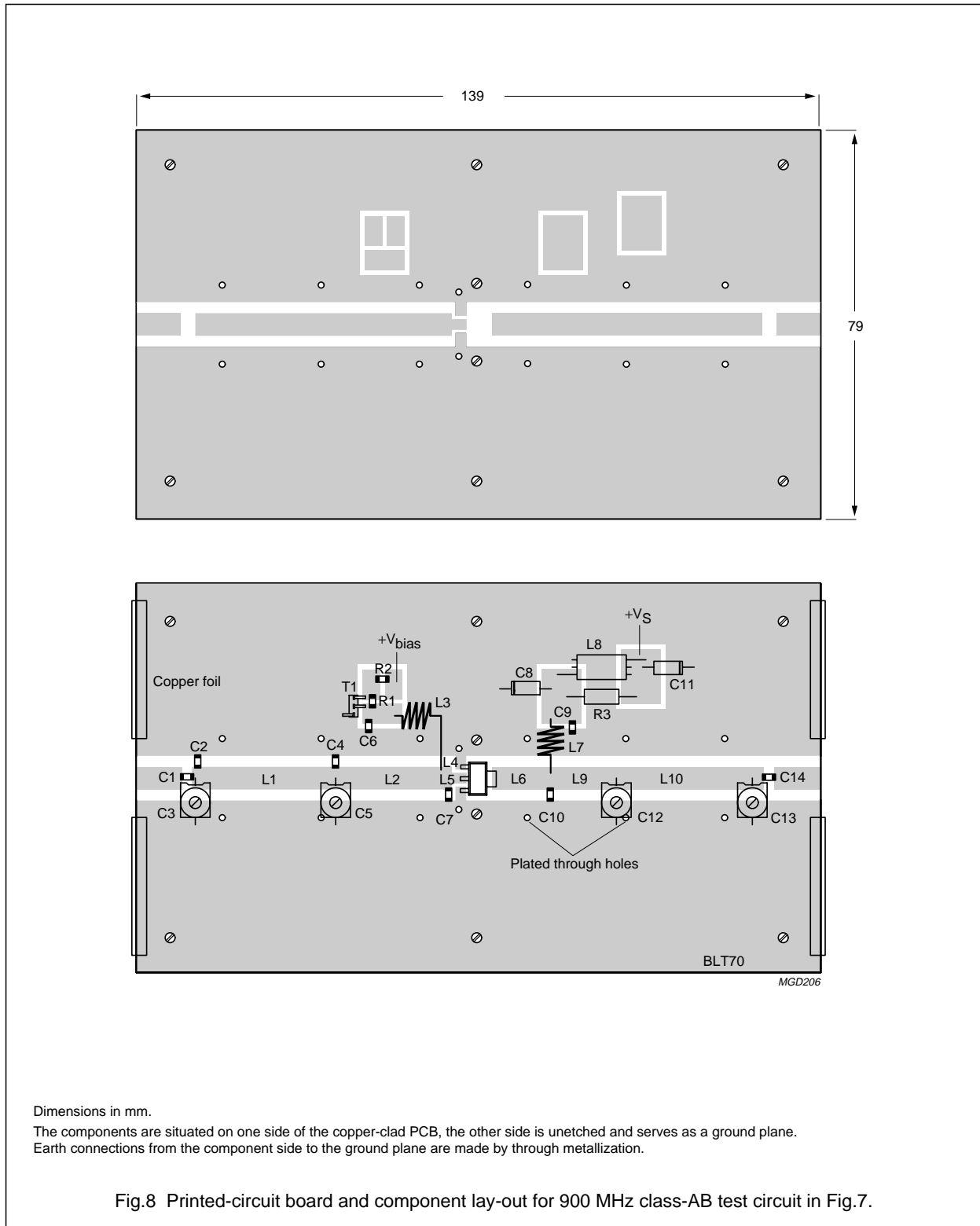

Dimensions in mm.

The components are situated on one side of the copper-clad PCB, the other side is unetched and serves as a ground plane. Earth connections from the component side to the ground plane are made by through metallization.

Fig.8 Printed-circuit board and component lay-out for 900 MHz class-AB test circuit in Fig.7.

UHF power transistor

BLT70

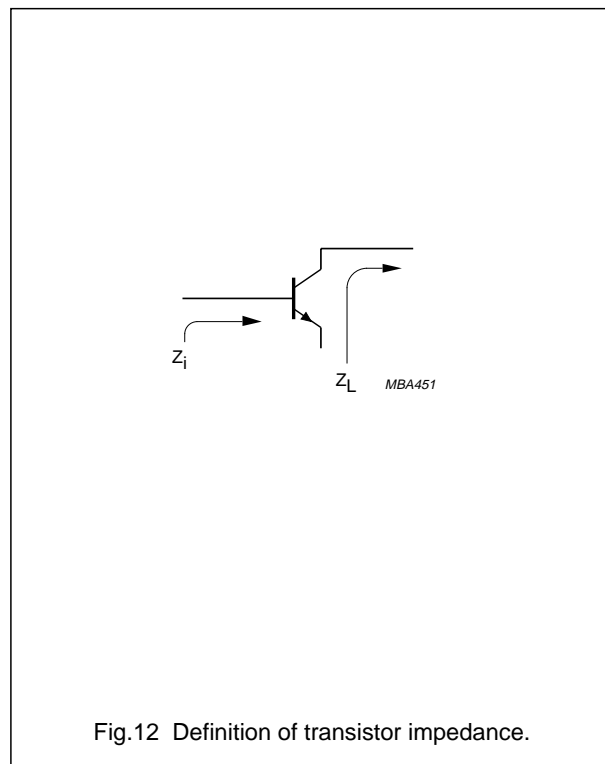
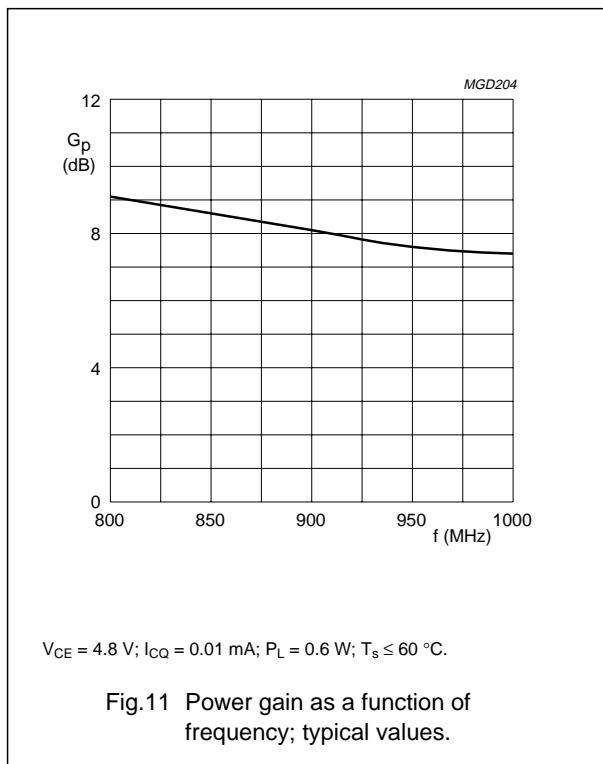
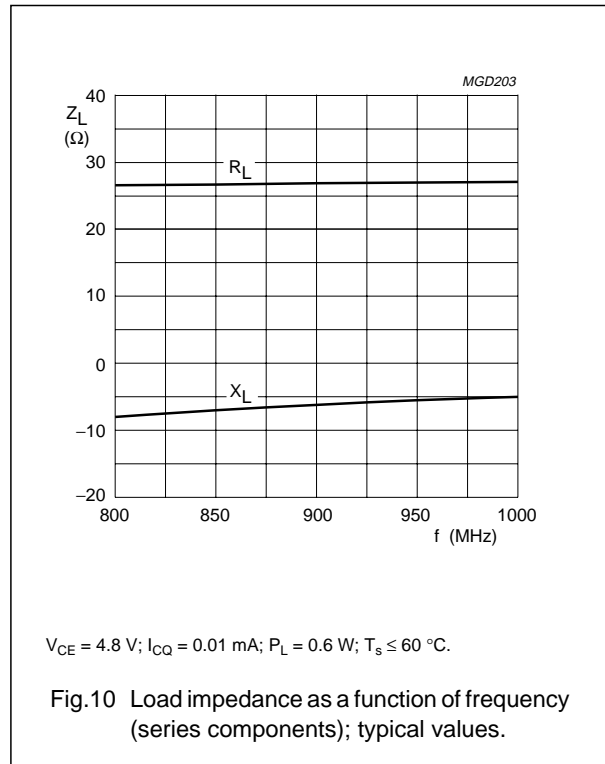
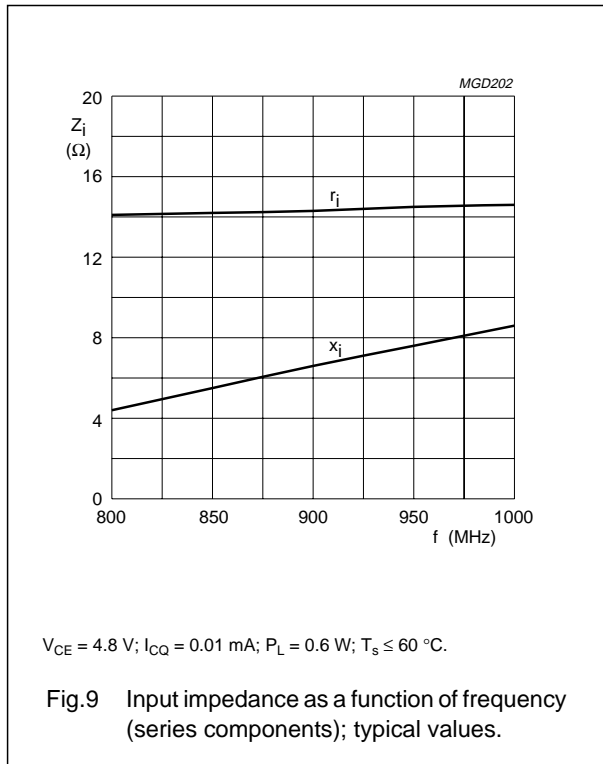

UHF power transistor

BLT70

DEFINITIONS

Data Sheet Status	
Objective specification	This data sheet contains target or goal specifications for product development.
Preliminary specification	This data sheet contains preliminary data; supplementary data may be published later.
Product specification	This data sheet contains final product specifications.
Limiting values	
Limiting values given are in accordance with the Absolute Maximum Rating System (IEC 134). Stress above one or more of the limiting values may cause permanent damage to the device. These are stress ratings only and operation of the device at these or at any other conditions above those given in the Characteristics sections of the specification is not implied. Exposure to limiting values for extended periods may affect device reliability.	
Application information	
Where application information is given, it is advisory and does not form part of the specification.	

LIFE SUPPORT APPLICATIONS

These products are not designed for use in life support appliances, devices, or systems where malfunction of these products can reasonably be expected to result in personal injury. Philips customers using or selling these products for use in such applications do so at their own risk and agree to fully indemnify Philips for any damages resulting from such improper use or sale.