

NPN Silicon RF Transistor

BFQ 82

- For low-noise, high-gain amplifiers up to 2 GHz.
- Linear broadband applications at collector currents up to 40 mA.
- Hermetically sealed ceramic package.
- $f_T = 8$ GHz
 $F = 1.1$ dB at 800 MHz

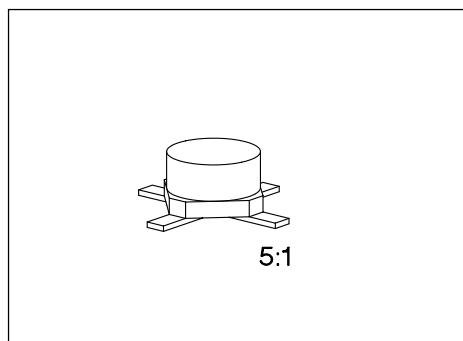

ESD: Electrostatic discharge sensitive device, observe handling precautions!

Type	Marking	Ordering Code (tape and reel)	Pin Configuration				Package ¹⁾
			1	2	3	4	
BFQ 82	82	Q62702-F1189	B	E	C	E	Cerrec-X

Maximum Ratings

Parameter	Symbol	Values	Unit
Collector-emitter voltage	V_{CE0}	12	V
Collector-emitter voltage, $V_{BE} = 0$	V_{CES}	20	
Collector-base voltage	V_{CB0}	20	
Emitter-base voltage	V_{EB0}	2	
Collector current	I_C	80	mA
Peak collector current, $f \geq 10$ MHz	I_{CM}	80	
Base current	I_B	10	
Peak base current, $f \geq 10$ MHz	I_{BM}	10	
Total power dissipation, $T_s \leq 95$ °C ³⁾	P_{tot}	500	mW
Junction temperature	T_j	175	°C
Ambient temperature range	T_A	- 65 ... + 175	
Storage temperature range	T_{stg}	- 65 ... + 175	

Thermal Resistance

Junction - ambient ²⁾	$R_{th JA}$	≤ 240	K/W
Junction - case ³⁾	$R_{th JS}$	≤ 160	

1) For detailed information see chapter Package Outlines.

2) Package mounted on alumina 15 mm × 16.7 mm × 0.7 mm.

3) T_s is measured on the collector lead at the soldering point to the pcb.

Electrical Characteristics

at $T_A = 25\text{ °C}$, unless otherwise specified.

Parameter	Symbol	Values			Unit
		min.	typ.	max.	

DC Characteristics

Collector-emitter breakdown voltage $I_C = 1\text{ mA}, I_B = 0$	$V_{(BR)CE0}$	12	–	–	V
Collector-emitter cutoff current $V_{CE} = 20\text{ V}, V_{BE} = 0$	I_{CES}	–	–	100	μA
Collector-base cutoff current $V_{CB} = 10\text{ V}, I_E = 0$ $V_{CB} = 10\text{ V}, I_E = 0, T_A = 125\text{ °C}$	I_{CBO}	– –	– –	0.05 5	
Emitter-base cutoff current $V_{EB} = 1\text{ V}, I_C = 0$	I_{EBO}	–	–	1	
DC current gain $I_C = 5\text{ mA}, V_{CE} = 8\text{ V}$ $I_C = 30\text{ mA}, V_{CE} = 8\text{ V}$	h_{FE}	– 50	110 120	– 250	–

Electrical Characteristics

at $T_A = 25\text{ °C}$, unless otherwise specified.

Parameter	Symbol	Values			Unit
		min.	typ.	max.	

AC Characteristics

Transition frequency $I_C = 5\text{ mA}$, $V_{CE} = 8\text{ V}$, $f = 500\text{ MHz}$ $I_C = 30\text{ mA}$, $V_{CE} = 8\text{ V}$, $f = 500\text{ MHz}$	f_t	–	3.6 8	–	GHz
Collector-base capacitance $V_{CB} = 10\text{ V}$, $V_{BE} = v_{be} = 0$, $f = 1\text{ MHz}$	C_{cb}	–	0.62	–	pF
Collector-emitter capacitance $V_{CE} = 10\text{ V}$, $V_{BE} = v_{be} = 0$, $f = 1\text{ MHz}$	C_{ce}	–	0.4	–	
Input capacitance $V_{EB} = 0.5\text{ V}$, $I_C = i_c = 0$, $f = 1\text{ MHz}$	C_{ibo}	–	2.5	–	
Output capacitance $V_{CE} = 10\text{ V}$, $V_{BE} = v_{be} = 0$, $f = 1\text{ MHz}$	C_{obs}	–	1.0	–	
Noise figure $I_C = 5\text{ mA}$, $V_{CE} = 8\text{ V}$, $f = 10\text{ MHz}$, $Z_S = 75\text{ }\Omega$ $I_C = 30\text{ mA}$, $V_{CE} = 8\text{ V}$, $f = 800\text{ MHz}$, $Z_S = Z_{Sopt}$ $I_C = 10\text{ mA}$, $V_{CE} = 8\text{ V}$, $f = 2\text{ GHz}$, $Z_S = Z_{Sopt}$	F	–	0.7 1.6 2.3	–	dB
Power gain $I_C = 30\text{ mA}$, $V_{CE} = 8\text{ V}$, $f = 1\text{ GHz}$, $Z_0 = 50\text{ }\Omega$ $I_C = 30\text{ mA}$, $V_{CE} = 8\text{ V}$, $f = 2\text{ GHz}$, $Z_0 = 50\text{ }\Omega$	$G_{ma}^{1)}$	–	17 11	–	
Transducer gain $I_C = 30\text{ mA}$, $V_{CE} = 8\text{ V}$, $f = 1\text{ GHz}$, $Z_0 = 50\text{ }\Omega$	$ S_{21e} ^2$	–	13.5	–	
Linear output voltage two-tone intermodulation test $I_C = 40\text{ mA}$, $V_{CE} = 8\text{ V}$, $d_{IM} = 60\text{ dB}$, $f_1 = 806\text{ MHz}$, $f_2 = 810\text{ MHz}$, $Z_S = Z_L = 50\text{ }\Omega$	$V_{o1} = V_{o2}$	–	280	–	mV
Third order intercept point $I_C = 40\text{ mA}$, $V_{CE} = 8\text{ V}$, $f = 800\text{ MHz}$	IP_3	–	32	–	dBm

1) $\left| \frac{S_{21e}}{S_{12e}} \right| (k - \sqrt{k^2 - 1})$

Total power dissipation $P_{tot} = f(T_A^*; T_S)$

* Package mounted on alumina

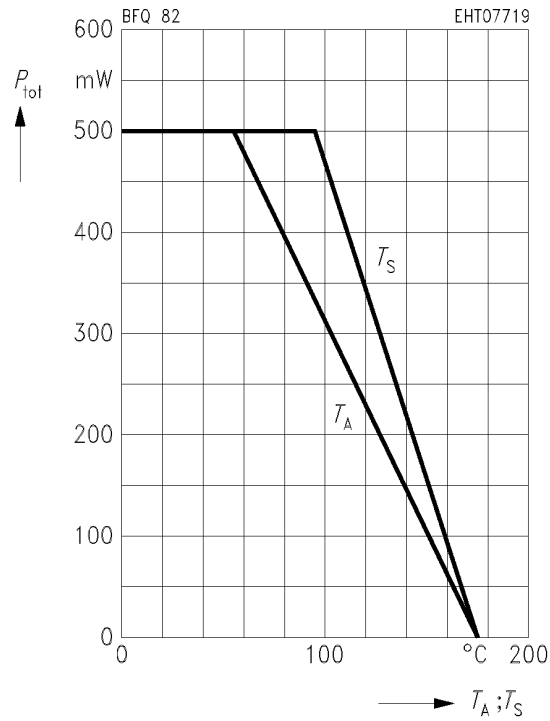

Transition frequency $f_T = f(I_C)$

$f = 500$ MHz

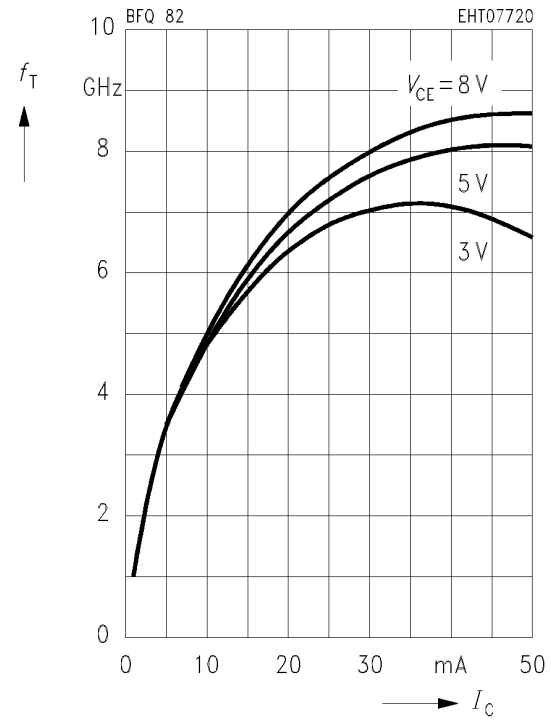

Collector-base capacitance $C_{cb} = f(V_{CB})$

$V_{BE} = v_{be} = 0, f = 1$ MHz

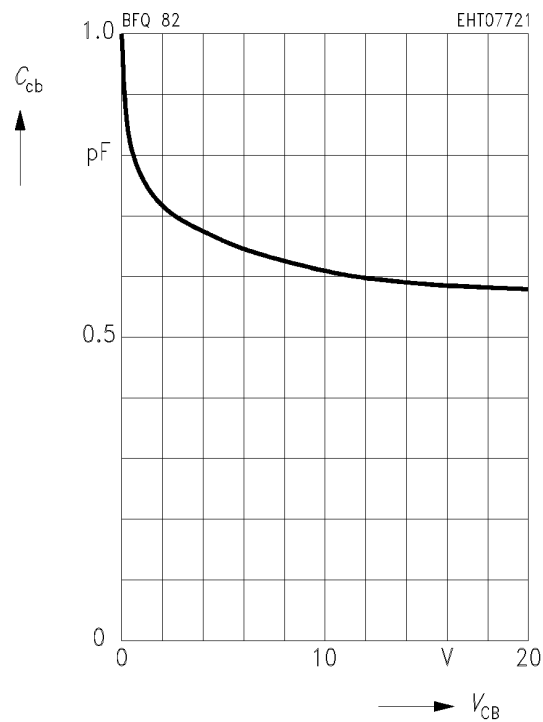

Common Emitter Noise Parameters

f	F_{min}	$G_p(F_{min})$	Γ_{opt}		R_N	N	$F_{50\Omega}$	$G_p(F_{50\Omega})$
GHz	dB	dB	MAG	ANG	Ω	-	dB	dB

$I_C = 10 \text{ mA}, V_{CE} = 8 \text{ V}, Z_0 = 50 \Omega$

0.01	1	-	$(Z_S = 75 \Omega)$		-	-	1.05	-
0.8	1.15	15.7	-	-	-	-	1.35	14.7
2.0	2.3	9.5	-	-	-	-	2.8	7.5

$I_C = 30 \text{ mA}, V_{CE} = 8 \text{ V}, Z_0 = 50 \Omega$

0.01	1.65	-	$(Z_S = 50 \Omega)$		-	-	1.65	-
0.8	1.6	17	-	-	-	-	1.95	15.8
2.0	2.6	10	-	-	-	-	3.3	8

Noise figure $F = f(I_C)$

$V_{CE} = 8 \text{ V}, f = 10 \text{ MHz}$

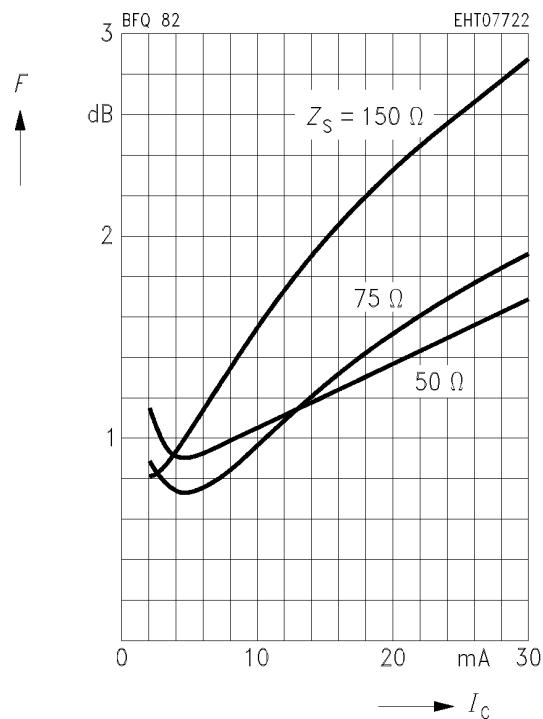

Noise figure $F = f(I_c)$

Power gain $G = f(I_c)$

$V_{CE} = 8 \text{ V}, f = 800 \text{ MHz}, Z_{Lopt}(G)$

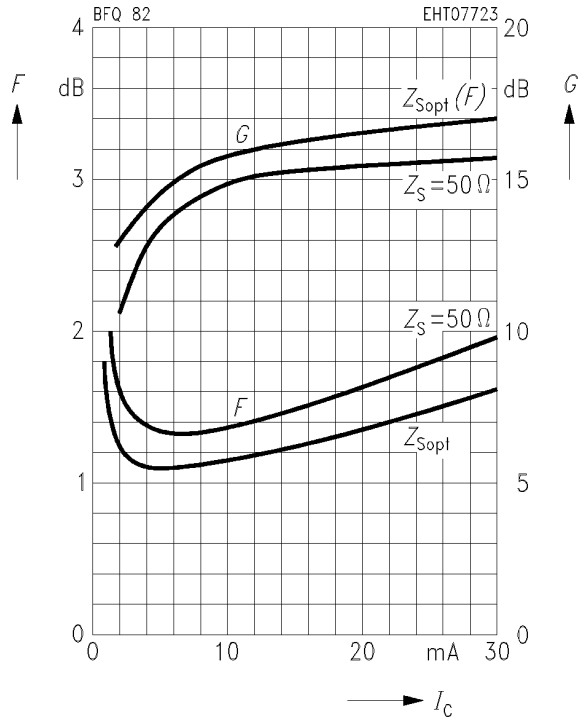

Noise figure $F = f(I_c)$

Power gain $G = f(I_c)$

$V_{CE} = 8 \text{ V}, f = 2 \text{ GHz}, Z_{Lopt}(G)$

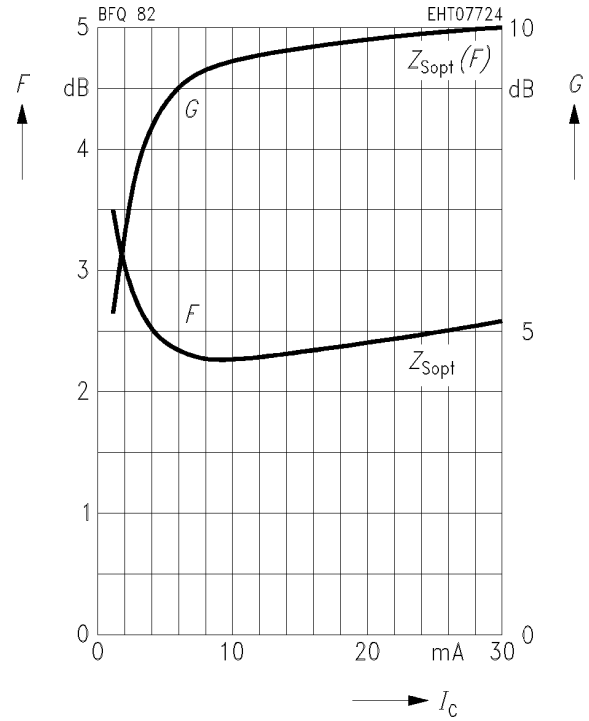

Common Emitter Power Gain

Power gain $G_{ms}, |S_{21e}|^2 = f(I_C)$

$V_{CE} = 8 \text{ V}, f = 200 \text{ MHz}, Z_0 = 50 \Omega$

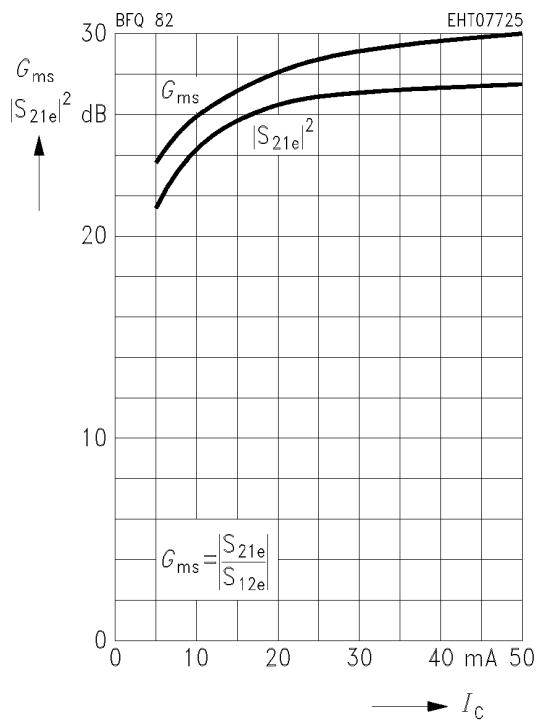

Power gain $G_{ms}, |S_{21e}|^2 = f(I_C)$

$V_{CE} = 8 \text{ V}, f = 500 \text{ MHz}, Z_0 = 50 \Omega$

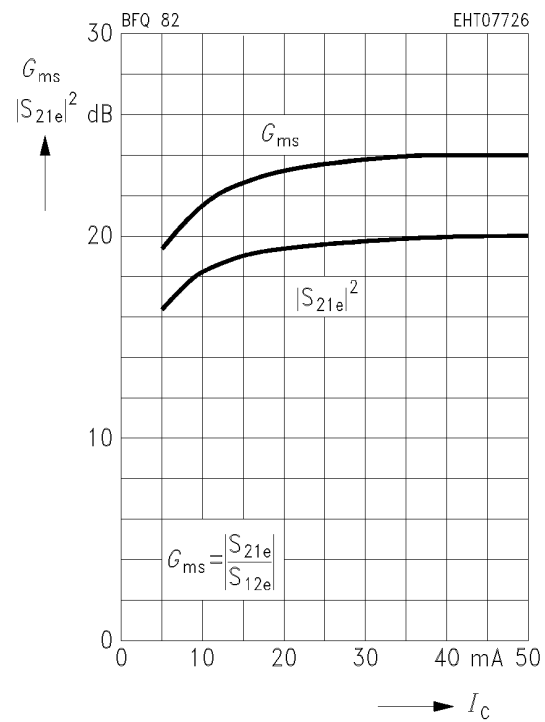

Power gain $G_{ma}, G_{ms}, |S_{21e}|^2 = f(I_C)$

$V_{CE} = 8 \text{ V}, f = 1 \text{ GHz}, Z_0 = 50 \Omega$

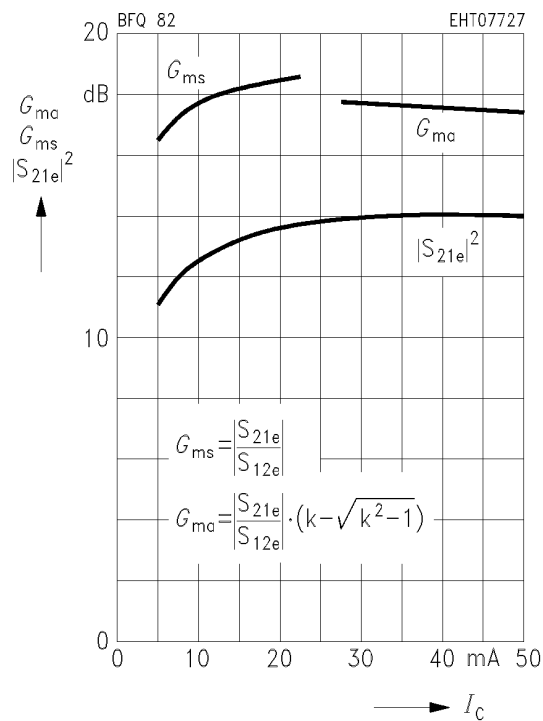

Power gain $G_{ma}, |S_{21e}|^2 = f(I_C)$

$V_{CE} = 8 \text{ V}, f = 2 \text{ GHz}, Z_0 = 50 \Omega$

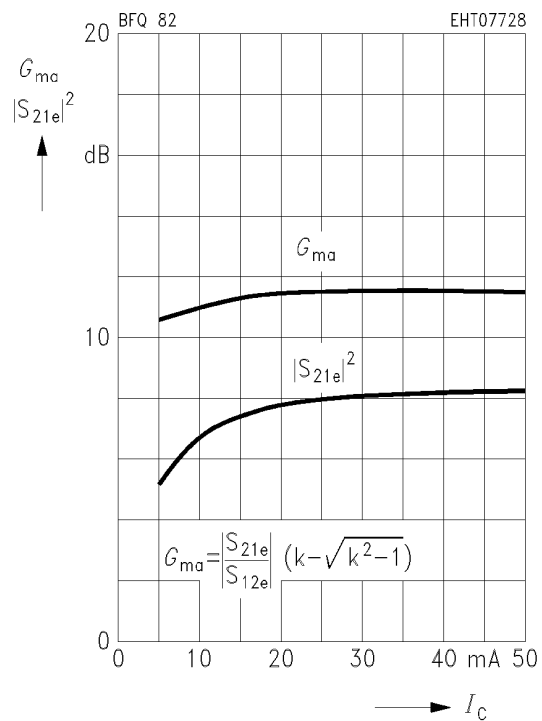

Power gain $G_{ma}, G_{ms}, |S_{21e}|^2 = f(f)$
 $I_C = 5 \text{ mA}, V_{CE} = 8 \text{ V}, Z_0 = 50 \Omega$

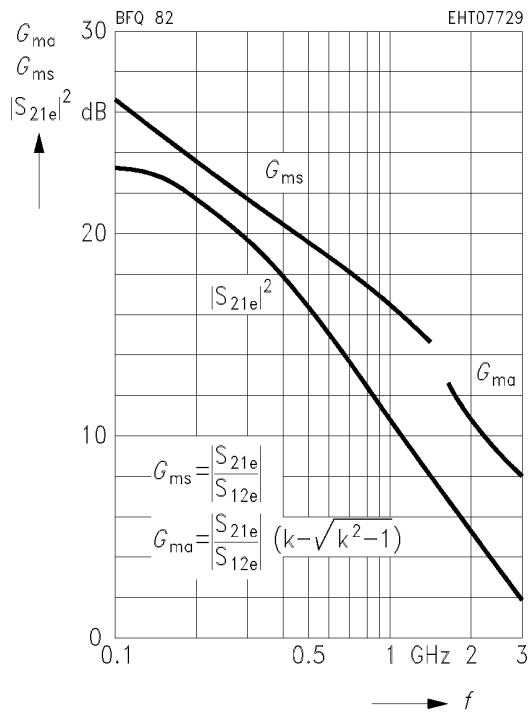

Power gain $G_{ma}, G_{ms}, |S_{21e}|^2 = f(f)$
 $I_C = 10 \text{ mA}, V_{CE} = 8 \text{ V}, Z_0 = 50 \Omega$

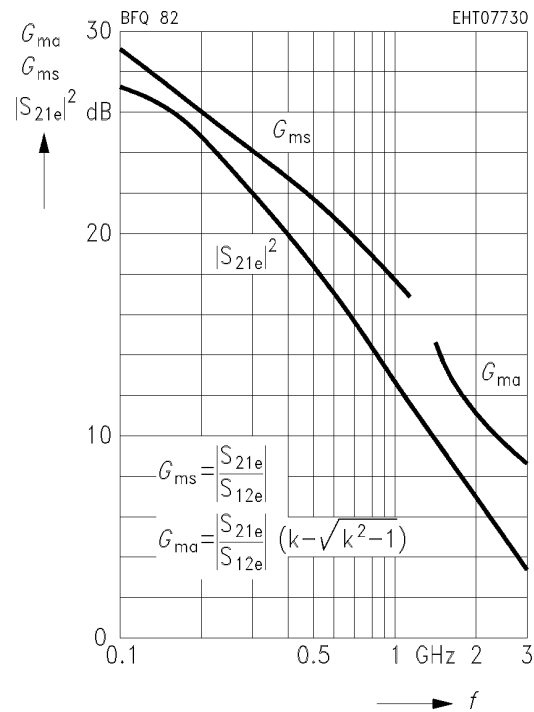

Power gain $G_{ma}, G_{ms}, |S_{21e}|^2 = f(f)$
 $I_C = 30 \text{ mA}, V_{CE} = 8 \text{ V}, Z_0 = 50 \Omega$

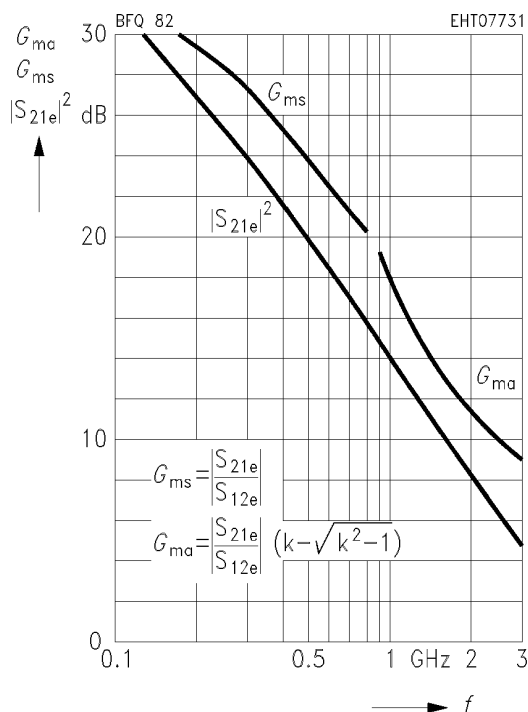

Power gain $G_{ma}, G_{ms}, |S_{21e}|^2 = f(f)$
 $I_C = 50 \text{ mA}, V_{CE} = 8 \text{ V}, Z_0 = 50 \Omega$

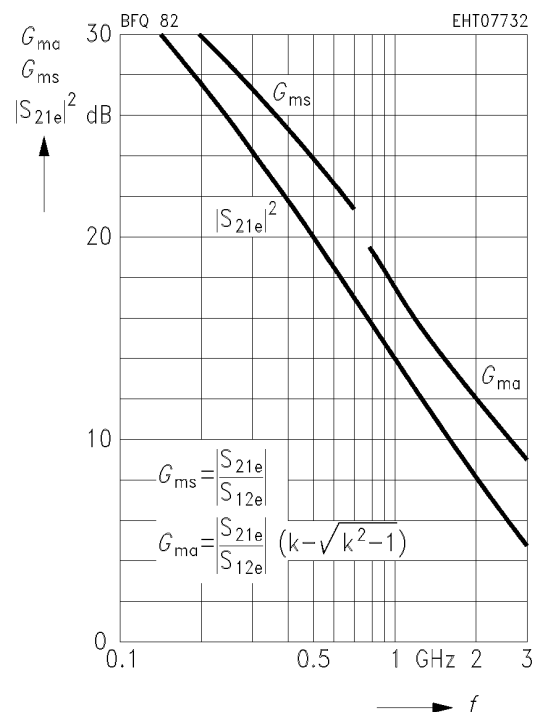

Common Emitter S Parameters

<i>f</i>	<i>S</i> ₁₁		<i>S</i> ₂₁		<i>S</i> ₁₂		<i>S</i> ₂₂	
	MAG	ANG	MAG	ANG	MAG	ANG	MAG	ANG

*I*_C = 10 mA, *V*_{CE} = 3 V, *Z*₀ = 50 Ω

0.10	0.549	- 117.0	34.54	127.9	0.020	53.4	0.627	- 55.5
0.15	0.598	- 136.2	26.39	116.1	0.023	48.5	0.486	- 69.3
0.20	0.620	- 147.9	20.98	108.4	0.026	47.7	0.394	- 79.1
0.25	0.633	- 155.9	17.29	103.0	0.028	47.7	0.333	- 86.8
0.30	0.641	- 161.4	14.67	98.9	0.031	48.7	0.288	- 93.1
0.40	0.651	- 169.7	11.21	92.7	0.035	51.2	0.234	- 103.1
0.50	0.655	- 175.5	9.06	87.8	0.040	53.3	0.203	- 110.8
0.60	0.657	- 180.0	7.60	83.8	0.045	54.9	0.183	- 117.4
0.70	0.661	175.8	6.53	80.1	0.051	56.1	0.170	- 123.1
0.80	0.665	172.6	5.74	76.6	0.056	56.9	0.161	- 127.8
0.90	0.671	169.6	5.09	73.6	0.061	57.2	0.154	- 132.8
1.00	0.673	166.7	4.58	70.6	0.067	57.5	0.149	- 136.9
1.20	0.680	161.2	3.82	65.6	0.078	57.4	0.142	- 145.3
1.40	0.679	155.8	3.31	60.6	0.089	56.7	0.139	- 150.8
1.50	0.680	153.4	3.10	58.1	0.095	55.8	0.140	- 152.4
1.60	0.683	151.1	2.92	55.3	0.101	55.1	0.141	- 154.4
1.80	0.688	146.7	2.59	49.9	0.112	53.1	0.146	- 159.0
2.00	0.701	143.0	2.33	45.3	0.122	51.3	0.151	- 165.6
2.50	0.729	133.3	1.90	35.3	0.150	46.8	0.175	- 178.4
3.00	0.735	122.1	1.62	23.5	0.177	40.6	0.199	174.5

*I*_C = 30 mA, *V*_{CE} = 3 V, *Z*₀ = 50 Ω

0.10	0.664	- 71.4	22.66	142.7	0.029	59.7	0.815	- 33.7
0.15	0.666	- 94.9	19.20	130.2	0.038	50.7	0.694	- 44.5
0.20	0.666	- 112.0	16.25	121.0	0.043	44.9	0.593	- 52.4
0.25	0.664	- 124.8	13.90	113.9	0.046	40.9	0.514	- 58.2
0.30	0.666	- 134.3	12.07	108.4	0.049	38.5	0.452	- 62.5
0.40	0.670	- 148.4	9.48	99.9	0.052	36.1	0.366	- 68.6
0.50	0.670	- 158.0	7.78	93.6	0.056	35.7	0.313	- 72.8
0.60	0.671	- 165.3	6.57	88.4	0.058	35.9	0.275	- 76.1
0.70	0.675	- 171.5	5.67	83.8	0.061	36.6	0.249	- 79.0
0.80	0.679	- 176.4	5.01	79.6	0.064	37.4	0.231	- 81.3
0.90	0.684	179.2	4.45	76.0	0.067	38.2	0.214	- 83.7
1.00	0.686	175.4	4.01	72.5	0.070	39.5	0.203	- 85.8
1.20	0.693	168.4	3.35	66.5	0.077	41.3	0.185	- 90.5
1.40	0.691	162.0	2.90	60.9	0.084	42.8	0.177	- 94.9
1.50	0.692	159.3	2.72	58.1	0.089	43.0	0.177	- 97.2
1.60	0.697	156.5	2.56	55.1	0.093	43.3	0.177	- 99.6
1.80	0.703	151.4	2.28	49.3	0.101	43.3	0.177	- 105.1
2.00	0.713	147.0	2.05	44.2	0.109	43.3	0.176	- 112.0
2.50	0.741	136.2	1.67	33.1	0.133	42.5	0.188	- 130.5
3.00	0.748	124.5	1.42	20.7	0.157	39.0	0.215	- 144.6

Common Emitter S Parameters (continued)

<i>f</i>	<i>S</i> ₁₁		<i>S</i> ₂₁		<i>S</i> ₁₂		<i>S</i> ₂₂	
	MAG	ANG	MAG	ANG	MAG	ANG	MAG	ANG
0.10	0.783	- 48.9	14.66	152.0	0.033	66.4	0.904	- 21.5
0.15	0.763	- 68.9	13.27	140.7	0.045	57.1	0.827	- 29.7
0.20	0.745	- 85.7	11.86	131.3	0.054	49.8	0.748	- 36.1
0.25	0.732	- 99.4	10.58	123.5	0.060	44.0	0.677	- 41.1
0.30	0.722	- 110.7	9.45	117.2	0.065	39.6	0.616	- 44.8
0.40	0.708	- 128.3	7.69	107.1	0.070	33.5	0.525	- 50.0
0.50	0.701	- 141.0	6.43	99.4	0.074	29.7	0.462	- 53.2
0.60	0.697	- 151.0	5.50	93.0	0.076	27.3	0.420	- 55.7
0.70	0.698	- 158.9	4.80	87.4	0.078	25.9	0.388	- 57.6
0.80	0.700	- 165.5	4.24	82.6	0.079	24.9	0.366	- 59.2
0.90	0.703	- 171.2	3.81	78.1	0.080	24.6	0.348	- 61.0
1.00	0.704	- 176.4	3.43	74.1	0.081	24.6	0.333	- 62.8
1.20	0.710	174.6	2.88	66.9	0.082	25.4	0.314	- 66.2
1.40	0.713	166.9	2.49	60.5	0.085	27.0	0.304	- 69.9
1.50	0.709	163.8	2.34	57.4	0.087	28.0	0.302	- 72.3
1.60	0.711	160.3	2.20	54.1	0.089	28.8	0.301	- 74.6
1.80	0.719	154.2	1.97	47.7	0.093	30.4	0.300	- 79.8
2.00	0.727	148.8	1.77	42.0	0.097	31.9	0.296	- 85.6
2.50	0.755	137.2	1.43	30.0	0.114	36.1	0.300	- 102.2
3.00	0.758	124.0	1.22	16.2	0.135	36.2	0.322	- 118.6

*I*_C = 5 mA, *V*_{CE} = 5 V, *Z*₀ = 50 Ω

*S*₁₁, *S*₂₂ = *f* (*f*)

*I*_C = 5 mA, *V*_{CE} = 5 V, *Z*₀ = 50 Ω

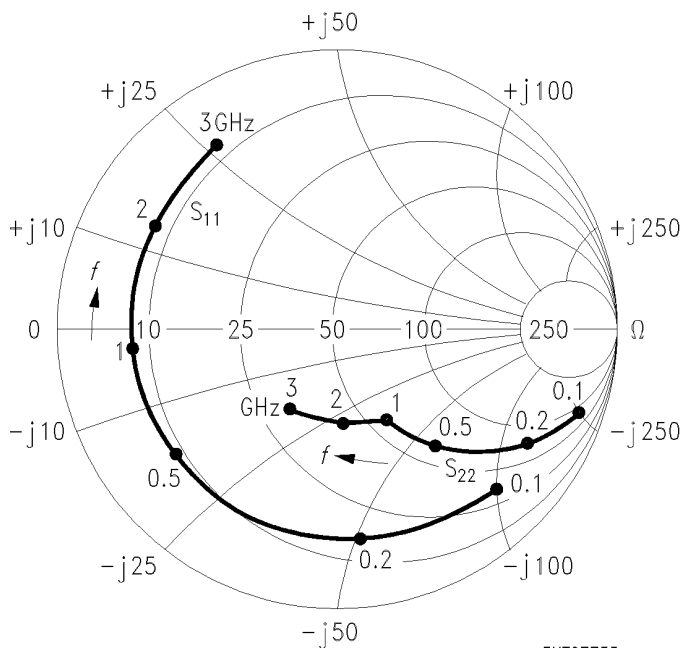

EHT07733

*S*₁₂, *S*₂₁ = *f* (*f*)

*I*_C = 5 mA, *V*_{CE} = 5 V, *Z*₀ = 50 Ω

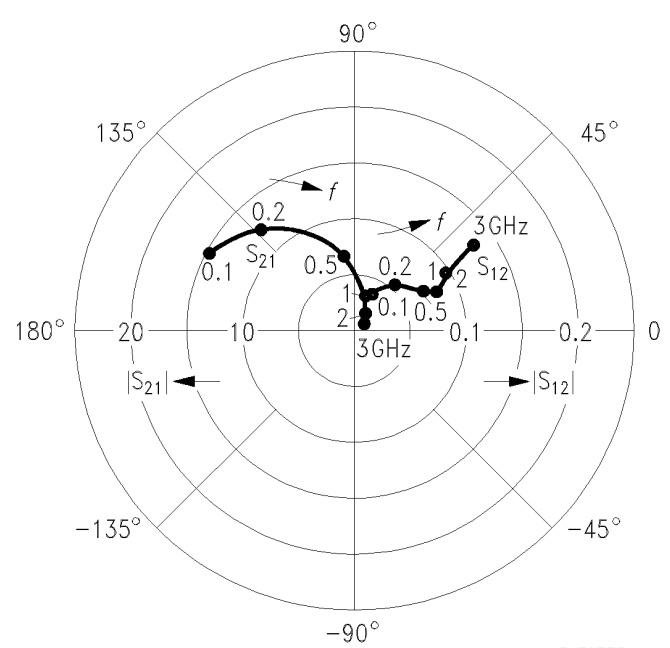

EHT07734

Common Emitter S Parameters (continued)

<i>f</i>	<i>S</i> ₁₁		<i>S</i> ₂₁		<i>S</i> ₁₂		<i>S</i> ₂₂	
	MAG	ANG	MAG	ANG	MAG	ANG	MAG	ANG
GHz								
<i>I</i> _C = 10 mA, <i>V</i> _{CE} = 5 V, <i>Z</i> ₀ = 50 Ω								
0.10	0.670	- 68.9	23.03	143.5	0.028	60.6	0.822	- 32.5
0.15	0.664	- 92.4	19.59	131.0	0.037	51.4	0.705	- 43.2
0.20	0.661	- 109.9	16.65	121.7	0.042	45.5	0.604	- 51.1
0.25	0.660	- 122.6	14.30	114.5	0.045	41.6	0.525	- 56.7
0.30	0.660	- 132.6	12.45	108.9	0.048	39.1	0.462	- 60.9
0.40	0.658	- 147.1	9.79	100.3	0.052	36.6	0.376	- 66.9
0.50	0.660	- 157.1	8.04	93.9	0.055	35.8	0.319	- 70.8
0.60	0.662	- 164.9	6.80	88.6	0.058	36.1	0.283	- 73.9
0.70	0.664	- 171.0	5.88	83.9	0.061	36.8	0.256	- 76.4
0.80	0.669	- 176.3	5.17	79.8	0.064	37.4	0.237	- 78.5
0.90	0.672	- 179.2	4.62	76.0	0.067	38.4	0.222	- 80.8
1.00	0.675	- 175.0	4.16	72.5	0.070	39.2	0.209	- 83.1
1.20	0.682	- 167.4	3.48	66.2	0.076	40.8	0.191	- 87.2
1.40	0.687	- 160.9	3.00	60.5	0.084	41.9	0.182	- 91.0
1.50	0.684	- 158.2	2.82	57.7	0.088	42.5	0.181	- 93.2
1.60	0.684	- 155.1	2.65	54.7	0.092	42.6	0.180	- 95.5
1.80	0.693	- 149.8	2.37	48.8	0.101	42.6	0.181	- 101.1
2.00	0.701	- 144.9	2.13	43.6	0.108	42.2	0.179	- 107.6
2.50	0.732	- 134.5	1.73	32.6	0.132	41.4	0.188	- 124.6
3.00	0.735	- 122.0	1.47	19.2	0.156	37.4	0.215	- 139.6

*S*₁₁, *S*₂₂ = *f* (*f*)

*I*_C = 10 mA, *V*_{CE} = 5 V, *Z*₀ = 50 Ω

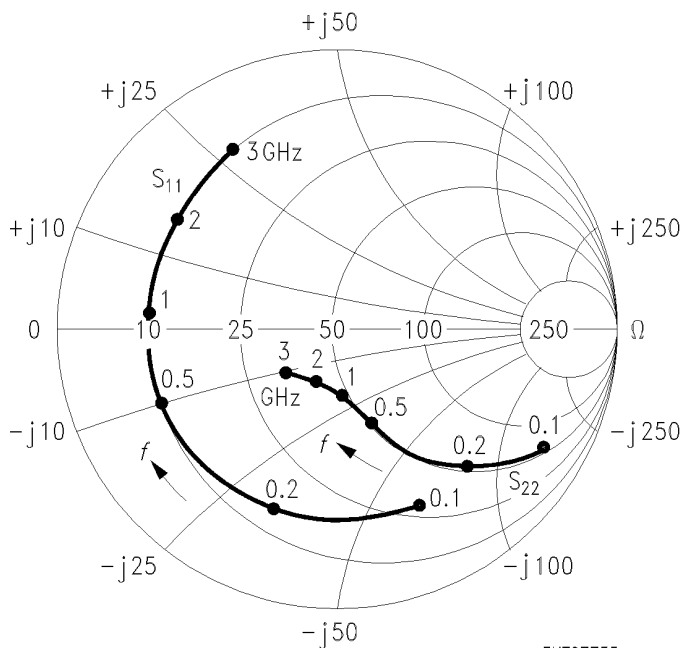

EHT07735

*S*₁₂, *S*₂₁ = *f* (*f*)

*I*_C = 10 mA, *V*_{CE} = 5 V, *Z*₀ = 50 Ω

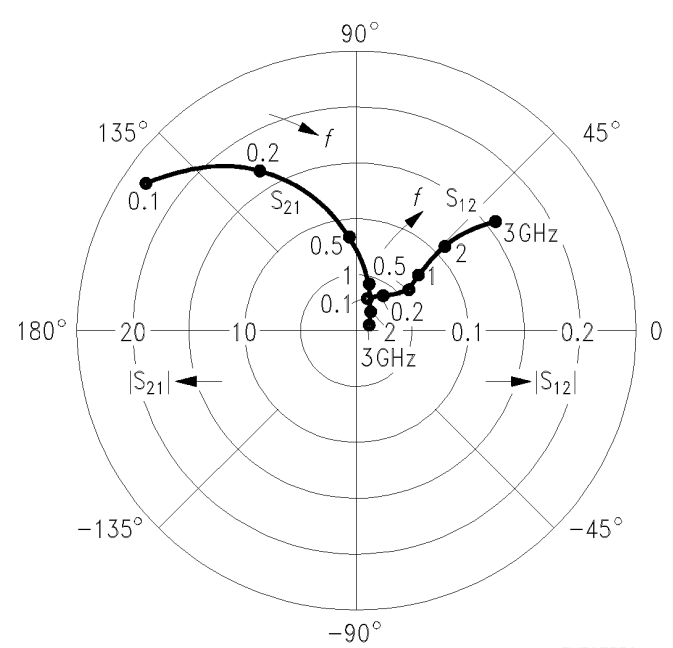

EHT07736

Common Emitter S Parameters (continued)

<i>f</i>	<i>S</i> ₁₁		<i>S</i> ₂₁		<i>S</i> ₁₂		<i>S</i> ₂₂	
	MAG	ANG	MAG	ANG	MAG	ANG	MAG	ANG
GHz								
<i>I</i> _C = 30 mA, <i>V</i> _{CE} = 5 V, <i>Z</i> ₀ = 50 Ω								
0.10	0.545	-111.4	35.72	129.0	0.020	54.2	0.642	-53.6
0.15	0.584	-132.2	27.43	117.1	0.023	49.3	0.501	-67.2
0.20	0.605	-145.0	21.91	109.2	0.026	47.9	0.407	-76.8
0.25	0.617	-153.2	18.11	103.7	0.029	47.9	0.342	-84.3
0.30	0.625	-159.3	15.39	99.5	0.031	48.7	0.297	-90.3
0.40	0.631	-168.3	11.77	93.0	0.035	50.9	0.239	-100.0
0.50	0.637	-174.7	9.54	88.2	0.040	52.8	0.205	-107.7
0.60	0.641	-179.7	7.99	84.0	0.046	54.4	0.184	-113.8
0.70	0.644	176.4	6.87	80.2	0.051	55.6	0.171	-119.2
0.80	0.648	172.8	6.03	76.8	0.056	56.2	0.161	-123.9
0.90	0.652	169.5	5.36	73.6	0.061	56.4	0.154	-128.3
1.00	0.657	166.4	4.82	70.7	0.067	56.6	0.148	-133.2
1.20	0.665	160.2	4.03	65.4	0.078	56.3	0.140	-140.9
1.40	0.671	154.6	3.47	60.3	0.089	55.5	0.134	-146.8
1.50	0.665	152.3	3.26	57.8	0.095	54.8	0.135	-148.8
1.60	0.666	149.6	3.06	55.0	0.101	54.0	0.136	-150.7
1.80	0.674	145.0	2.73	49.7	0.112	51.9	0.141	-155.2
2.00	0.682	141.1	2.45	44.8	0.122	49.9	0.146	-161.6
2.50	0.713	131.4	1.99	34.7	0.150	45.3	0.164	-174.4
3.00	0.715	119.8	1.69	22.1	0.175	38.8	0.191	178.0

*S*₁₁, *S*₂₂ = *f*(*f*)

*I*_C = 30 mA, *V*_{CE} = 5 V, *Z*₀ = 50 Ω

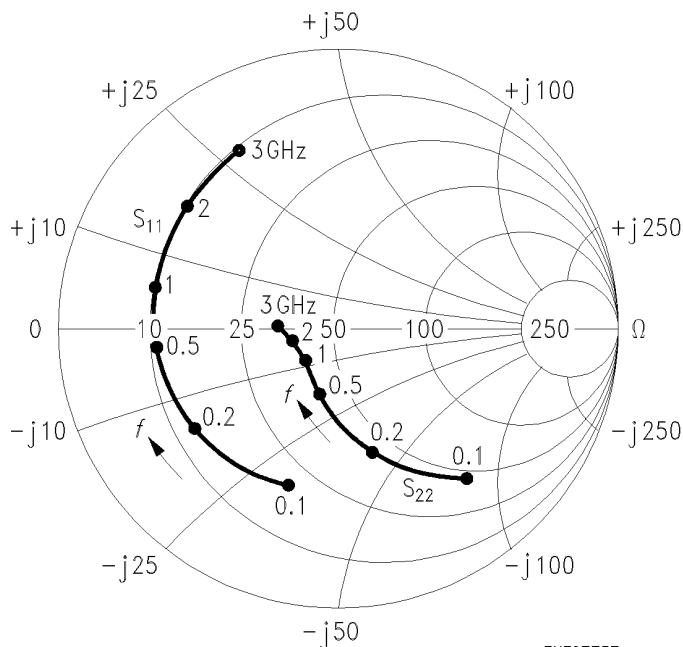

EHT07737

*S*₁₂, *S*₂₁ = *f*(*f*)

*I*_C = 30 mA, *V*_{CE} = 5 V, *Z*₀ = 50 Ω

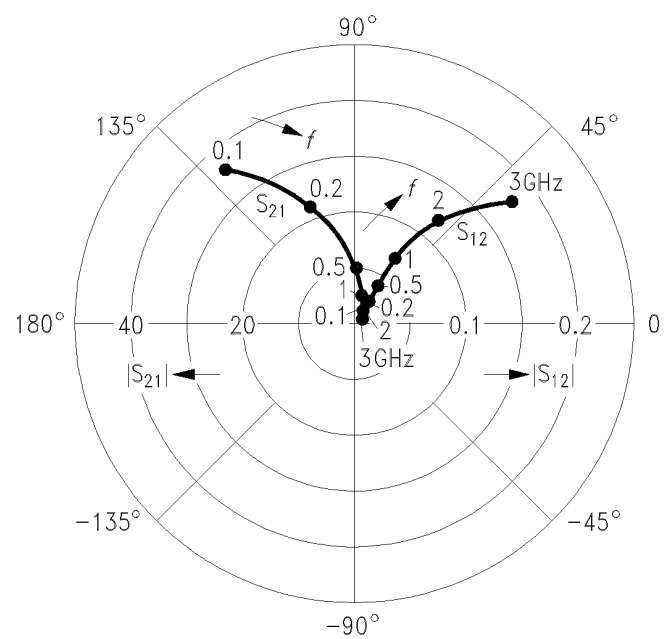

EHT07738

Common Emitter S Parameters (continued)

<i>f</i>	<i>S</i> ₁₁		<i>S</i> ₂₁		<i>S</i> ₁₂		<i>S</i> ₂₂	
	MAG	ANG	MAG	ANG	MAG	ANG	MAG	ANG
GHz								
<i>I</i> _C = 50 mA, <i>V</i> _{CE} = 5 V, <i>Z</i> ₀ = 50 Ω								
0.10	0.541	-128.9	38.90	123.5	0.016	53.8	0.560	-62.3
0.15	0.587	-145.8	28.86	112.3	0.020	51.3	0.425	-76.6
0.20	0.609	-155.7	22.67	105.3	0.022	51.6	0.344	-87.0
0.25	0.622	-162.0	18.56	100.5	0.025	53.0	0.291	-95.2
0.30	0.629	-166.9	15.69	96.7	0.027	54.7	0.255	-101.9
0.40	0.635	-173.9	11.94	90.9	0.032	57.5	0.212	-112.8
0.50	0.640	-179.2	9.64	86.4	0.038	59.3	0.186	-121.3
0.60	0.645	176.3	8.07	82.5	0.044	60.4	0.172	-127.8
0.70	0.649	173.1	6.93	79.0	0.050	61.1	0.164	-133.4
0.80	0.651	169.8	6.08	75.8	0.055	61.2	0.157	-138.2
0.90	0.656	167.0	5.41	72.7	0.061	61.1	0.153	-142.6
1.00	0.660	164.0	4.85	69.9	0.067	60.8	0.151	-147.3
1.20	0.668	158.5	4.05	64.7	0.079	59.9	0.147	-154.8
1.40	0.673	153.1	3.49	59.9	0.091	58.5	0.143	-160.5
1.50	0.668	150.9	3.28	57.3	0.097	57.6	0.144	-162.2
1.60	0.671	148.3	3.09	54.7	0.103	56.5	0.145	-163.8
1.80	0.676	143.8	2.75	49.4	0.115	53.9	0.150	-167.6
2.00	0.685	140.1	2.46	44.6	0.125	51.5	0.157	-173.2
2.50	0.716	130.6	2.00	34.7	0.153	46.4	0.177	175.7
3.00	0.717	119.1	1.70	22.2	0.179	39.2	0.202	169.6

*S*₁₁, *S*₂₂ = *f*(*f*)

*I*_C = 50 mA, *V*_{CE} = 5 V, *Z*₀ = 50 Ω

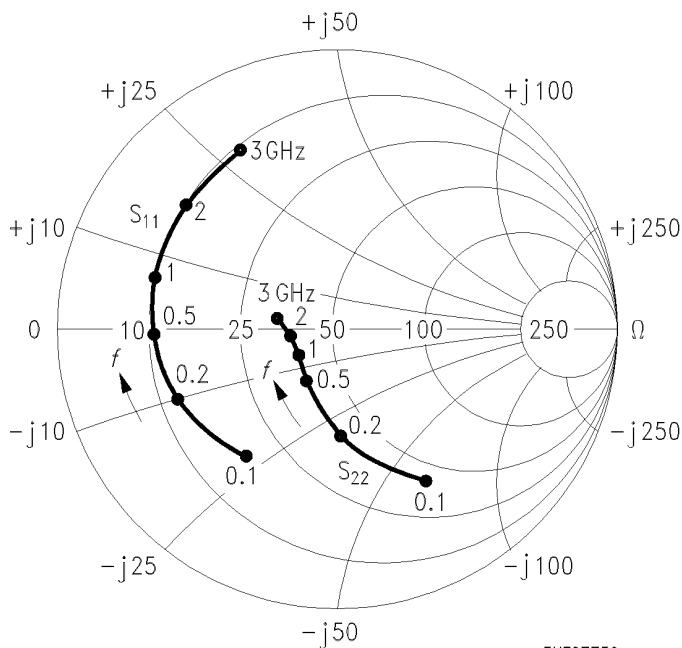

EHT07739

*S*₁₂, *S*₂₁ = *f*(*f*)

*I*_C = 50 mA, *V*_{CE} = 5 V, *Z*₀ = 50 Ω

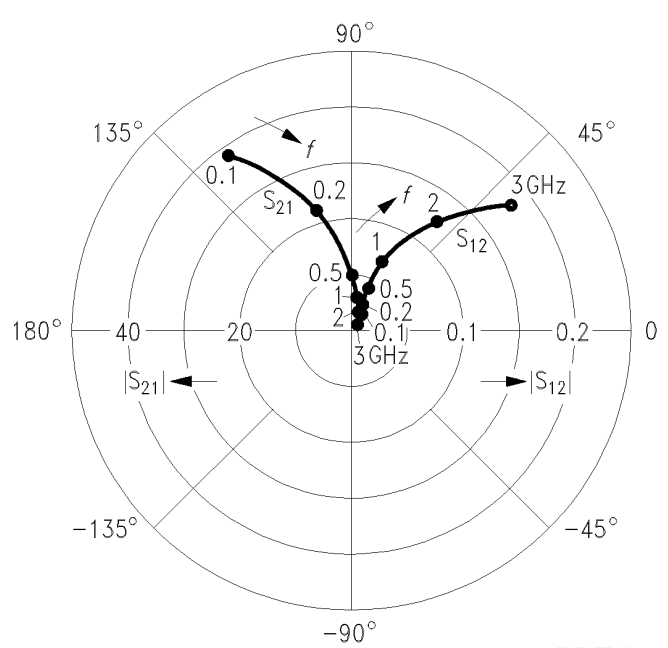

EHT07740

Common Emitter S Parameters (continued)

<i>f</i>	<i>S</i> ₁₁		<i>S</i> ₂₁		<i>S</i> ₁₂		<i>S</i> ₂₂	
	MAG	ANG	MAG	ANG	MAG	ANG	MAG	ANG
GHz								
<i>I</i> _C = 5 mA, <i>V</i> _{CE} = 8 V, <i>Z</i> ₀ = 50 Ω								
0.10	0.792	- 47.3	14.67	152.6	0.033	66.9	0.908	- 20.9
0.15	0.771	- 67.0	13.33	141.4	0.044	57.6	0.833	- 28.9
0.20	0.751	- 83.6	11.96	132.1	0.053	50.5	0.756	- 35.2
0.25	0.736	- 97.1	10.69	124.4	0.059	44.8	0.686	- 40.1
0.30	0.724	- 108.5	9.57	118.0	0.064	40.3	0.626	- 43.9
0.40	0.707	- 126.2	7.82	107.8	0.070	34.1	0.535	- 49.0
0.50	0.699	- 139.2	6.55	100.1	0.073	30.1	0.472	- 52.3
0.60	0.695	- 149.4	5.61	93.6	0.076	27.6	0.428	- 54.7
0.70	0.695	- 157.5	4.90	88.1	0.077	26.3	0.397	- 56.6
0.80	0.696	- 164.3	4.33	83.2	0.079	25.1	0.374	- 58.2
0.90	0.698	- 170.0	3.89	78.7	0.080	24.9	0.355	- 59.9
1.00	0.699	- 175.4	3.51	74.6	0.080	24.8	0.340	- 61.6
1.20	0.704	175.4	2.95	67.4	0.082	25.5	0.320	- 64.9
1.40	0.708	167.6	2.54	61.0	0.085	27.0	0.310	- 68.6
1.50	0.706	164.5	2.39	58.0	0.086	27.9	0.308	- 70.9
1.60	0.705	160.9	2.25	54.6	0.088	28.8	0.307	- 73.1
1.80	0.715	154.8	2.01	48.3	0.093	30.3	0.305	- 78.3
2.00	0.723	149.3	1.81	42.6	0.096	31.9	0.301	- 83.9
2.50	0.750	137.4	1.47	30.6	0.113	35.9	0.303	- 100.1
3.00	0.755	124.3	1.25	16.8	0.134	36.1	0.323	- 116.5

*S*₁₁, *S*₂₂ = *f* (*f*)

*I*_C = 5 mA, *V*_{CE} = 8 V, *Z*₀ = 50 Ω

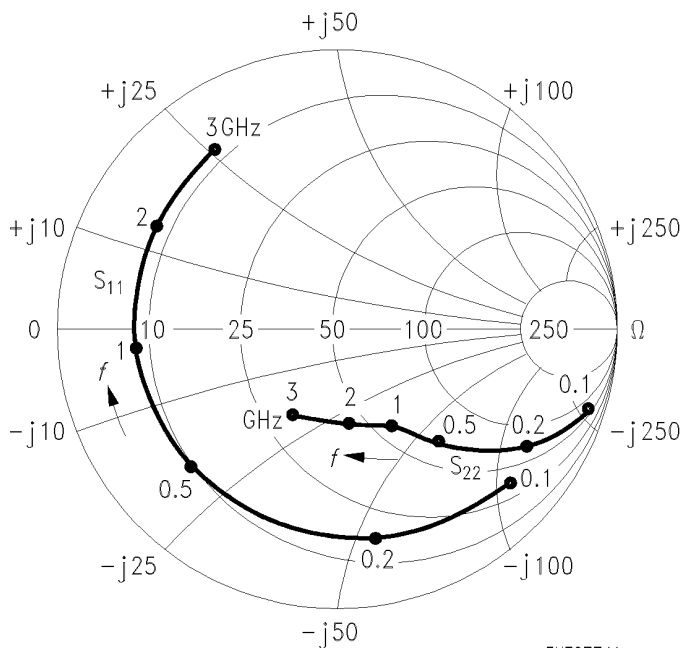

EHT07741

*S*₁₂, *S*₂₁ = *f* (*f*)

*I*_C = 5 mA, *V*_{CE} = 8 V, *Z*₀ = 50 Ω

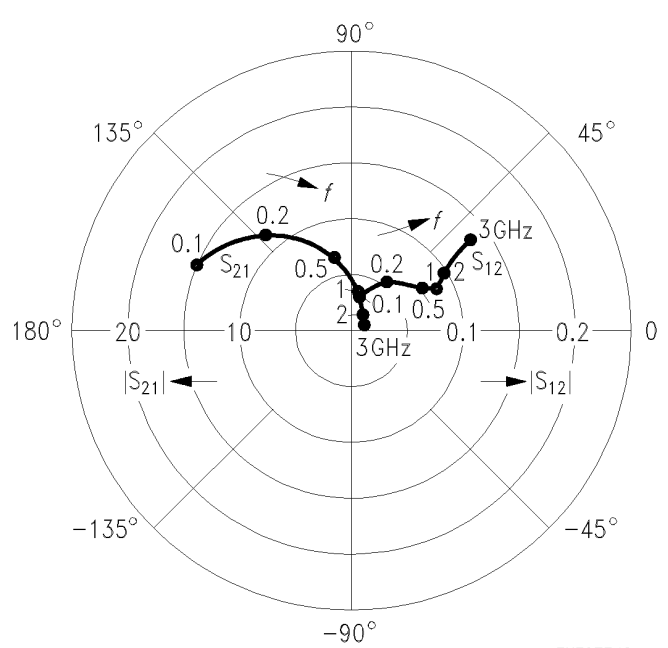

EHT07742

Common Emitter S Parameters (continued)

<i>f</i>	<i>S</i> ₁₁		<i>S</i> ₂₁		<i>S</i> ₁₂		<i>S</i> ₂₂	
	MAG	ANG	MAG	ANG	MAG	ANG	MAG	ANG
0.10	0.686	- 65.8	23.05	144.4	0.028	61.2	0.829	- 31.5
0.15	0.673	- 89.1	19.74	132.0	0.036	52.4	0.715	- 42.0
0.20	0.665	- 106.6	16.85	122.6	0.042	46.2	0.616	- 49.8
0.25	0.661	- 119.6	14.51	115.5	0.045	42.1	0.537	- 55.4
0.30	0.659	- 129.8	12.67	109.8	0.048	39.5	0.474	- 59.6
0.40	0.654	- 144.7	10.00	101.1	0.052	36.8	0.386	- 65.5
0.50	0.654	- 155.3	8.22	94.6	0.055	35.9	0.328	- 69.4
0.60	0.656	- 163.2	6.95	89.2	0.058	35.9	0.291	- 72.4
0.70	0.659	- 169.5	6.02	84.5	0.061	36.6	0.264	- 74.9
0.80	0.661	- 175.1	5.30	80.3	0.064	37.1	0.243	- 76.9
0.90	0.666	- 179.6	4.74	76.5	0.067	38.0	0.227	- 79.1
1.00	0.668	176.1	4.26	73.0	0.070	38.8	0.213	- 81.4
1.20	0.674	168.4	3.56	66.7	0.077	40.4	0.196	- 85.1
1.40	0.680	161.7	3.07	61.0	0.084	41.5	0.185	- 88.8
1.50	0.677	158.9	2.88	58.2	0.088	42.0	0.184	- 91.0
1.60	0.676	155.7	2.72	55.3	0.092	42.2	0.183	- 93.2
1.80	0.687	150.4	2.42	49.4	0.100	42.1	0.183	- 98.7
2.00	0.693	145.5	2.18	44.1	0.108	41.8	0.180	- 105.0
2.50	0.724	134.9	1.77	33.1	0.131	41.1	0.187	- 122.0
3.00	0.726	122.3	1.51	19.8	0.154	37.2	0.212	- 137.2

*I*_C = 10 mA, *V*_{CE} = 8 V, *Z*₀ = 50 Ω

*S*₁₁, *S*₂₂ = *f* (*f*)

*I*_C = 10 mA, *V*_{CE} = 8 V, *Z*₀ = 50 Ω

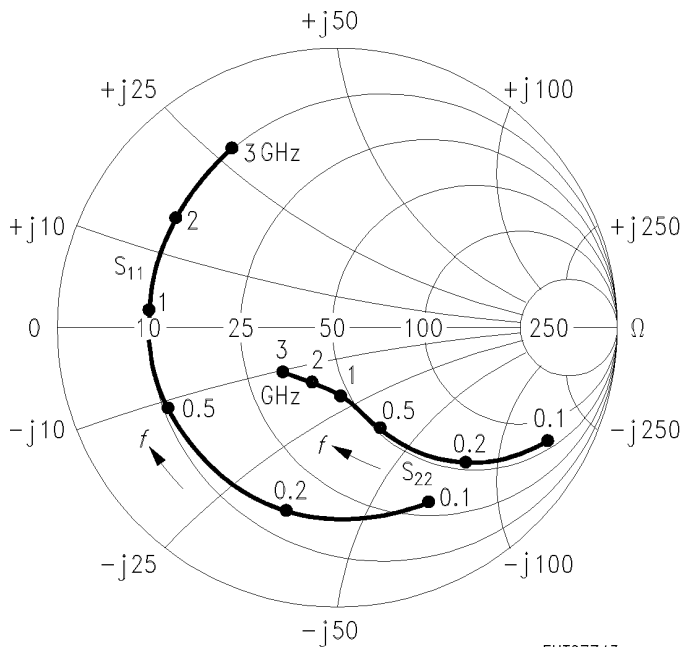

EHT07743

*S*₁₂, *S*₂₁ = *f* (*f*)

*I*_C = 10 mA, *V*_{CE} = 8 V, *Z*₀ = 50 Ω

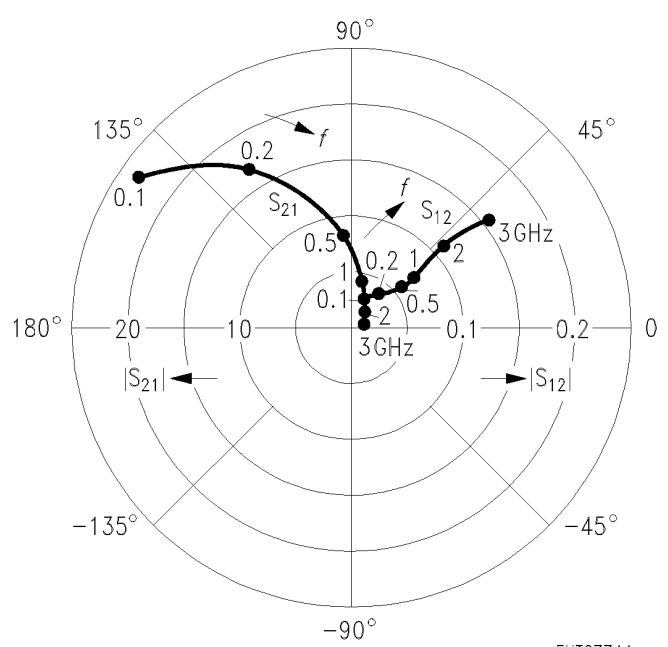

EHT07744

Common Emitter S Parameters (continued)

<i>f</i>	<i>S</i> ₁₁		<i>S</i> ₂₁		<i>S</i> ₁₂		<i>S</i> ₂₂	
	MAG	ANG	MAG	ANG	MAG	ANG	MAG	ANG
GHz								
<i>I</i> _C = 30 mA, <i>V</i> _{CE} = 8 V, <i>Z</i> ₀ = 50 Ω								
0.10	0.559	- 105.0	36.41	130.0	0.020	54.4	0.651	- 52.3
0.15	0.585	- 127.1	28.14	117.9	0.024	49.3	0.510	- 65.9
0.20	0.600	- 140.8	22.54	110.0	0.027	47.2	0.415	- 75.6
0.25	0.610	- 149.6	18.67	104.4	0.029	47.2	0.350	- 82.9
0.30	0.616	- 156.3	15.87	100.1	0.032	47.8	0.303	- 89.0
0.40	0.621	- 166.0	12.17	93.5	0.036	50.2	0.244	- 98.6
0.50	0.626	- 172.7	9.86	88.6	0.041	51.9	0.208	- 106.2
0.60	0.628	- 178.1	8.27	84.4	0.046	53.2	0.187	- 112.3
0.70	0.633	177.6	7.11	80.7	0.051	54.6	0.172	- 117.8
0.80	0.636	173.8	6.24	77.2	0.056	55.2	0.161	- 122.5
0.90	0.641	170.7	5.55	74.1	0.062	55.6	0.154	- 127.0
1.00	0.646	167.3	4.99	71.1	0.067	55.7	0.148	- 131.9
1.20	0.653	161.1	4.17	65.8	0.078	55.6	0.138	- 139.8
1.40	0.657	155.4	3.59	60.8	0.089	54.8	0.132	- 145.8
1.50	0.655	153.1	3.37	58.2	0.095	54.2	0.132	- 147.8
1.60	0.654	150.4	3.17	55.5	0.101	53.3	0.133	- 149.8
1.80	0.663	145.8	2.82	50.2	0.112	51.3	0.138	- 154.5
2.00	0.671	141.6	2.53	45.3	0.122	49.2	0.142	- 161.1
2.50	0.702	132.0	2.06	35.3	0.149	44.8	0.159	- 174.2
3.00	0.706	120.2	1.75	22.6	0.174	38.3	0.185	178.2

*S*₁₁, *S*₂₂ = *f* (*f*)

*I*_C = 30 mA, *V*_{CE} = 8 V, *Z*₀ = 50 Ω

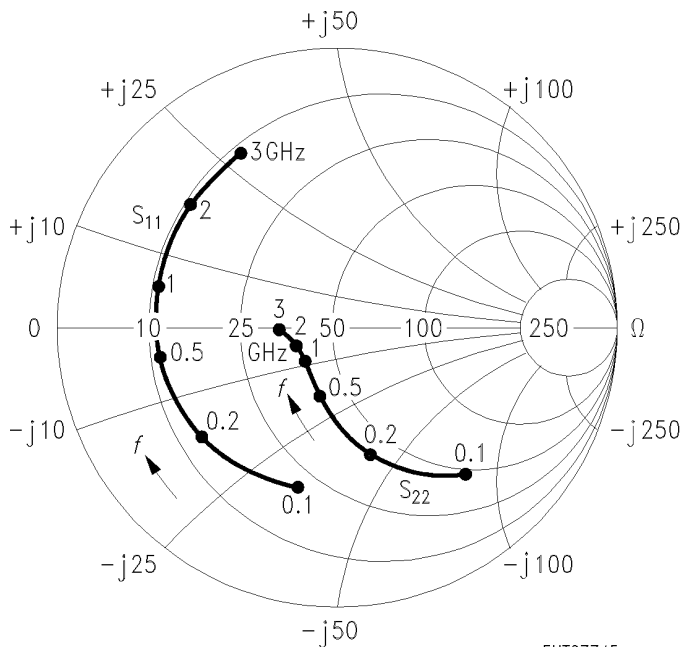

EHT07745

*S*₁₂, *S*₂₁ = *f* (*f*)

*I*_C = 30 mA, *V*_{CE} = 8 V, *Z*₀ = 50 Ω

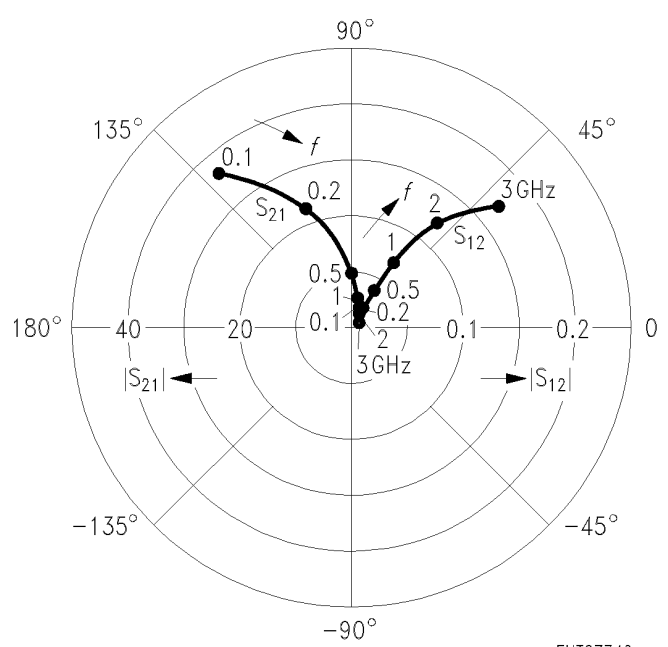

EHT07746

Common Emitter S Parameters (continued)

<i>f</i>	<i>S</i> ₁₁		<i>S</i> ₂₁		<i>S</i> ₁₂		<i>S</i> ₂₂	
	MAG	ANG	MAG	ANG	MAG	ANG	MAG	ANG
GHz								
<i>I</i> _C = 50 mA, <i>V</i> _{CE} = 8 V, <i>Z</i> ₀ = 50 Ω								
0.10	0.548	-120.2	39.95	124.5	0.017	53.4	0.569	-60.7
0.15	0.582	-139.4	29.82	113.2	0.020	50.0	0.434	-75.0
0.20	0.599	-150.9	23.47	106.0	0.023	50.2	0.351	-85.2
0.25	0.610	-158.0	19.26	101.1	0.026	51.5	0.296	-93.2
0.30	0.616	-163.4	16.29	97.3	0.028	53.1	0.259	-99.9
0.40	0.621	-171.5	12.41	91.4	0.033	55.7	0.213	-110.7
0.50	0.625	-177.3	10.01	86.9	0.039	57.7	0.186	-119.1
0.60	0.629	-178.2	8.39	83.0	0.045	58.9	0.171	-125.6
0.70	0.632	-174.6	7.20	79.4	0.050	59.7	0.162	-131.4
0.80	0.636	-171.1	6.32	76.2	0.056	59.9	0.155	-136.2
0.90	0.640	-168.1	5.62	73.1	0.062	59.9	0.151	-140.8
1.00	0.644	-165.1	5.05	70.3	0.067	59.7	0.147	-145.6
1.20	0.652	-159.2	4.21	65.2	0.079	58.9	0.142	-153.4
1.40	0.657	-153.8	3.63	60.4	0.091	57.5	0.138	-159.4
1.50	0.653	-151.6	3.41	57.8	0.097	56.6	0.138	-161.1
1.60	0.655	-149.0	3.21	55.1	0.103	55.5	0.139	-162.8
1.80	0.663	-144.5	2.85	49.9	0.115	53.0	0.145	-166.7
2.00	0.670	-140.8	2.56	45.1	0.125	50.8	0.151	-172.7
2.50	0.700	-131.2	2.08	35.3	0.153	45.6	0.169	-176.0
3.00	0.704	-119.6	1.77	22.7	0.178	38.6	0.193	-169.8

*S*₁₁, *S*₂₂ = *f*(*f*)

*I*_C = 50 mA, *V*_{CE} = 8 V, *Z*₀ = 50 Ω

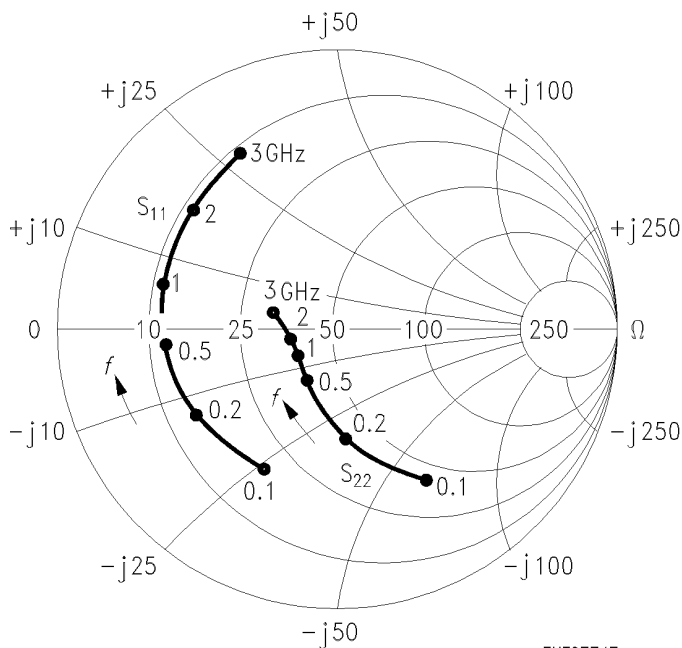

EHT07747

*S*₁₂, *S*₂₁ = *f*(*f*)

*I*_C = 50 mA, *V*_{CE} = 8 V, *Z*₀ = 50 Ω

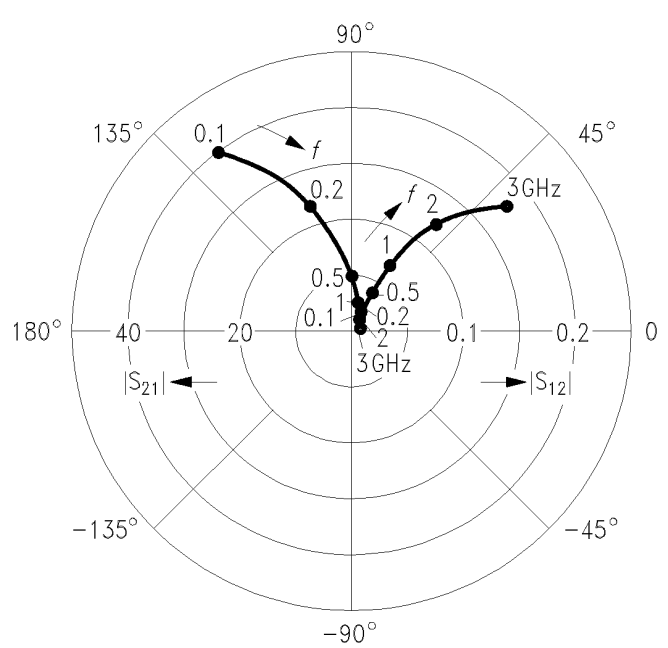

EHT07748

Common Emitter Large Signal Parameters

Linear output voltage $V_o = f(I_C)$

$V_{CE} = 8 \text{ V}$, $d_{IM} = 60 \text{ dB}$, $f_1 = 806 \text{ MHz}$,
 $f_2 = 810 \text{ MHz}$, $Z_S = Z_L = 50 \Omega$

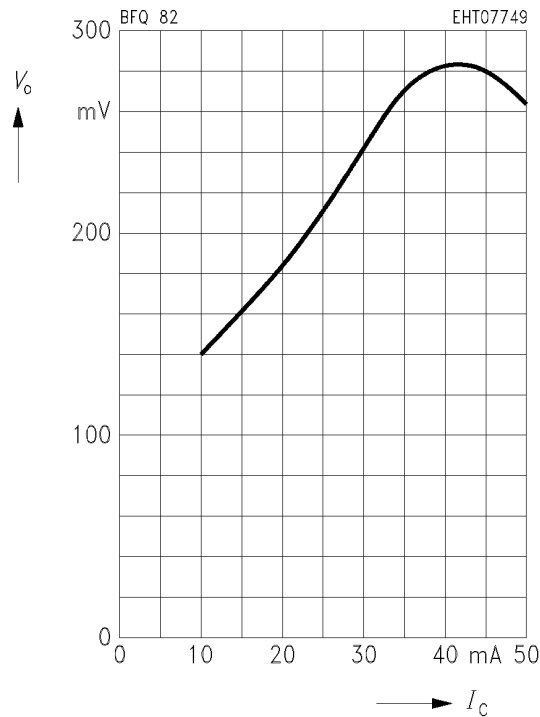

Note:

The transistor is driven by 2 adjacent signals f_1, f_2 with equal output power levels P_o for each carrier.

The distance d_{IM} between P_o and the third order intermodulation products P_{IM} ($2f_1 - f_2$ or $2f_2 - f_1$) is:

$$d_{IM} = P_o - P_{IM}$$

where $P_o = 10 \log (V_o^2 / (50 \Omega \cdot 1 \text{ mW}))$ (dBm)

and $V_o =$ linear output voltage of each carrier.

The 3rd order intercept point IP_3 will be found by extrapolation to the point where P_{IM} would be identical to P_o :

$$IP_3 (\text{output}) = P_o + d_{IM}/2.$$

Linear output voltages for other d_{IM} (e.g. 50 dB) can be calculated thereby.