

NPN Silicon RF Transistor

BFQ 29P

- For low-noise IF and broadband amplifiers up to 1 GHz at collector currents from 1 mA to 20 mA.
- CECC-type available: CECC 50002/258.

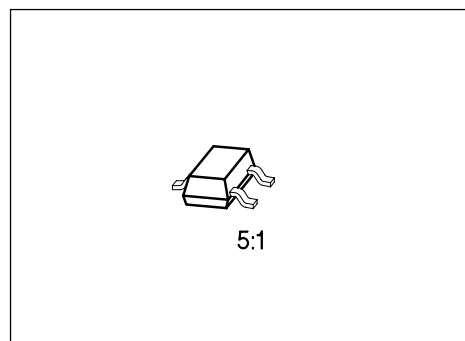

ESD: Electrostatic discharge sensitive device, observe handling precautions!

Type	Marking	Ordering Code (tape and reel)	Pin Configuration			Package ¹⁾
			1	2	3	
BFQ 29P	KC	Q62702-F659	B	E	C	SOT-23

Maximum Ratings

Parameter	Symbol	Values	Unit
Collector-emitter voltage	V_{CE0}	15	V
Collector-base voltage	V_{CB0}	20	
Emitter-base voltage	V_{EB0}	3	
Collector current	I_C	30	mA
Base current	I_B	4	
Total power dissipation, $T_s \leq 65 \text{ }^\circ\text{C}^3)$	P_{tot}	280	mW
Junction temperature	T_j	150	$^\circ\text{C}$
Ambient temperature range	T_A	- 65 ... + 150	
Storage temperature range	T_{stg}	- 65 ... + 150	

Thermal Resistance

Junction - ambient ²⁾	$R_{th JA}$	≤ 385	K/W
Junction - soldering point ³⁾	$R_{th JS}$	≤ 305	

1) For detailed dimensions see chapter Package Outlines.

2) Package mounted on alumina 15 mm × 16.7 mm × 0.7 mm.

3) T_s is measured on the collector lead at the soldering point to the pcb.

Electrical Characteristics

at $T_A = 25\text{ °C}$, unless otherwise specified.

Parameter	Symbol	Values			Unit
		min.	typ.	max.	

DC Characteristics

Collector-emitter breakdown voltage $I_C = 1\text{ mA}$, $I_B = 0$	$V_{(BR)CE0}$	15	–	–	V
Collector-base cutoff current $V_{CB} = 10\text{ V}$, $I_E = 0$ $V_{CB} = 20\text{ V}$, $I_E = 0$	I_{CB0}	– –	– –	0.05 10	μA
Emitter-base cutoff current $V_{EB} = 3\text{ V}$, $I_C = 0$	I_{EB0}	–	–	100	μA
DC current gain $I_C = 3\text{ mA}$, $V_{CE} = 6\text{ V}$ $I_C = 10\text{ mA}$, $V_{CE} = 6\text{ V}$	h_{FE}	50 50	– 140	250 –	–
Collector-emitter saturation voltage $I_C = 20\text{ mA}$, $I_B = 1\text{ mA}$	V_{CEsat}	–	0.1	0.4	V

Electrical Characteristics

at $T_A = 25\text{ }^\circ\text{C}$, unless otherwise specified.

Parameter	Symbol	Values			Unit
		min.	typ.	max.	

AC Characteristics

Transition frequency $I_C = 3\text{ mA}$, $V_{CE} = 6\text{ V}$, $f = 200\text{ MHz}$ $I_C = 20\text{ mA}$, $V_{CE} = 6\text{ V}$, $f = 200\text{ MHz}$	f_t	– 3.6	2.7 5	– –	GHz
Collector-base capacitance $V_{CB} = 10\text{ V}$, $V_{BE} = v_{be} = 0$, $f = 1\text{ MHz}$	C_{cb}	–	0.5	0.65	pF
Collector-emitter capacitance $V_{CE} = 10\text{ V}$, $V_{BE} = v_{be} = 0$, $f = 1\text{ MHz}$	C_{ce}	–	0.28	–	
Input capacitance $V_{EB} = 0.5\text{ V}$, $I_C = i_c = 0$, $f = 1\text{ MHz}$	C_{ibo}	–	1.35	–	
Output capacitance $V_{CE} = 10\text{ V}$, $V_{BE} = v_{be} = 0$, $f = 1\text{ MHz}$	C_{obs}	–	0.8	–	
Noise figure $I_C = 3\text{ mA}$, $V_{CE} = 6\text{ V}$, $f = 10\text{ MHz}$, $Z_S = 75\text{ }\Omega$ $I_C = 4\text{ mA}$, $V_{CE} = 6\text{ V}$, $f = 800\text{ MHz}$, $Z_S = 50\text{ }\Omega$	F	– –	0.9 1.5	1.2 –	dB
Power gain $I_C = 20\text{ mA}$, $V_{CE} = 6\text{ V}$, $f = 800\text{ MHz}$, $Z_0 = 50\text{ }\Omega$, $Z_L = Z_{Lopt}$	G_{pe}	–	14	–	
Transducer gain $I_C = 20\text{ mA}$, $V_{CE} = 6\text{ V}$, $f = 1\text{ GHz}$, $Z_0 = 50\text{ }\Omega$	$ S_{21e} ^2$	–	11	–	
Linear output voltage two-tone intermodulation test $I_C = 20\text{ mA}$, $V_{CE} = 6\text{ V}$, $d_{IM} = 60\text{ dB}$, $f_1 = 806\text{ MHz}$, $f_2 = 810\text{ MHz}$, $Z_S = Z_L = 50\text{ }\Omega$	$V_{o1} = V_{o2}$	–	180	–	mV
Third order intercept point $I_C = 20\text{ mA}$, $V_{CE} = 6\text{ V}$, $f = 800\text{ MHz}$	IP_3	–	28	–	dBm

Total power dissipation $P_{tot} = f(T_A^*; T_S)$

*Package mounted on alumina

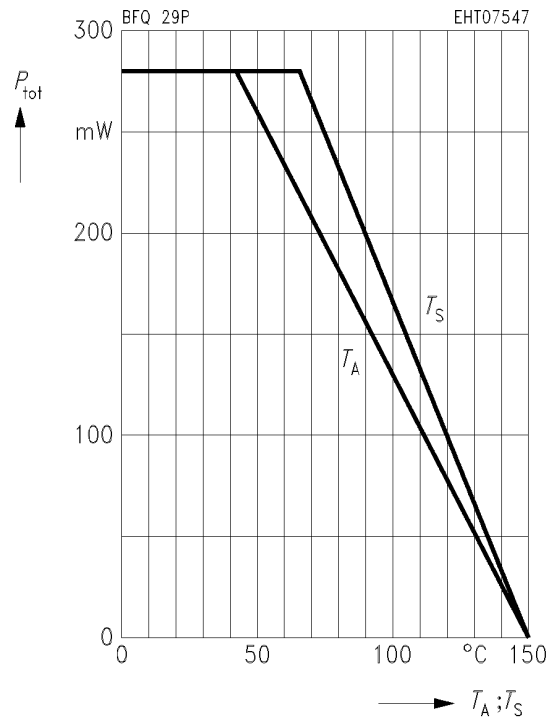

Transition frequency $f_T = f(I_C)$

$V_{CE} = 6\text{ V}, f = 200\text{ MHz}$

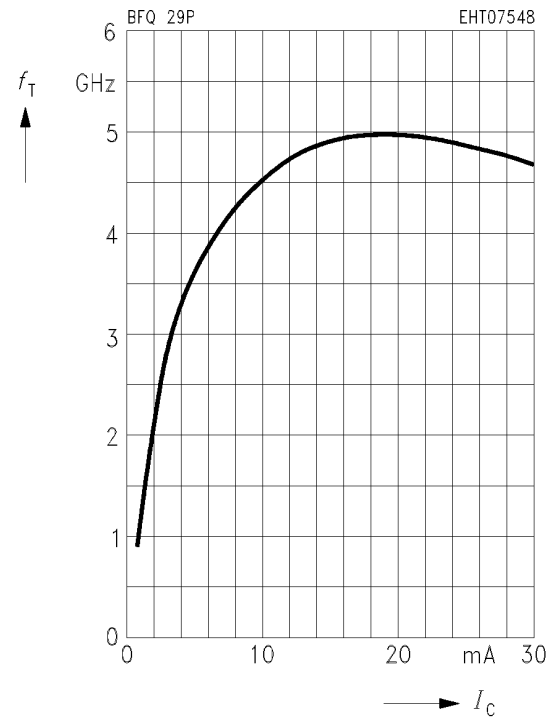

Collector-base capacitance $C_{cb} = f(V_{CB})$

$V_{BE} = v_{be} = 0, f = 1\text{ MHz}$

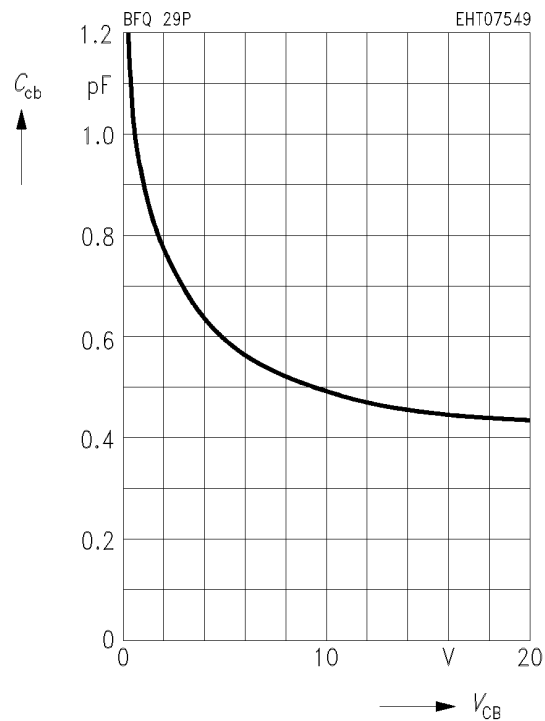

Common Emitter Noise Parameters

f GHz	F_{min} dB	$G_p(F_{min})$ dB	Γ_{opt}		R_N Ω	N -	$F_{50\Omega}$ dB	$G_p(F_{50\Omega})$ dB
			MAG	ANG				

$I_C = 3\text{ mA}, V_{CE} = 6\text{ V}, Z_0 = 50\ \Omega$

0.01	0.85	-	(Z _s = 130 Ω)		-	-	1.2	-
------	------	---	----------------------------------	--	---	---	-----	---

$I_C = 5\text{ mA}, V_{CE} = 6\text{ V}, Z_0 = 50\ \Omega$

0.01	0.85	-	(Z _s = 100 Ω)		-	-	1.1	-
0.8	1.25	13	0.25	93.5	11.1	0.20	1.45	14

Noise figure $F = f(Z_s)$

$V_{CE} = 6\text{ V}, f = 10\text{ MHz}$

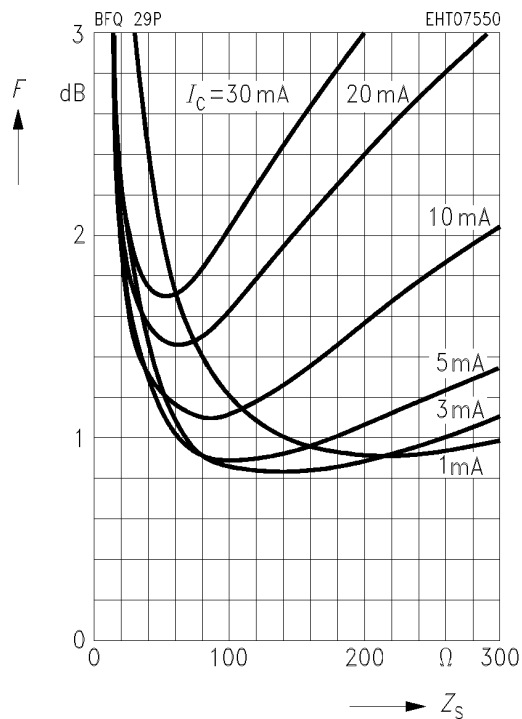

Circles of constant noise figure $F = f(Z_s)$
 in Z_s -plane, $I_C = 5 \text{ mA}$, $V_{CE} = 6 \text{ V}$, $f = 800 \text{ MHz}$

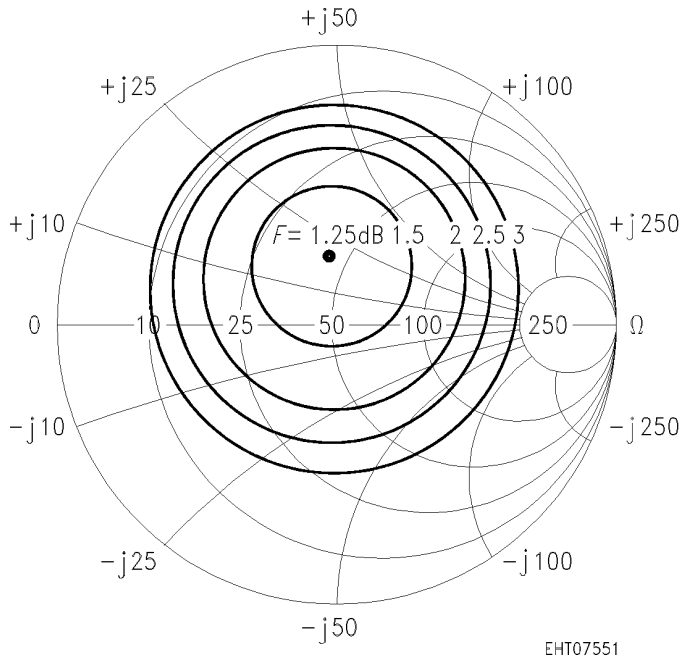

Noise figure $F = f(I_C)$
 $V_{CE} = 6 \text{ V}$, $f = 800 \text{ MHz}$, $Z_{Lopt} (G)$

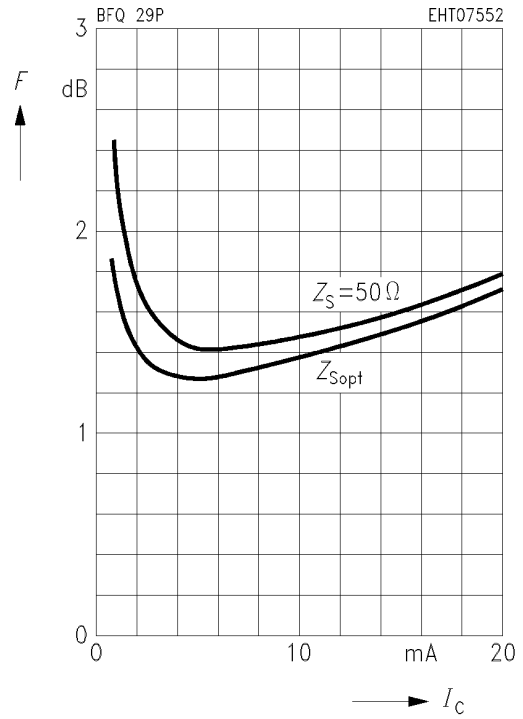

Common Emitter S Parameters

f	S_{11}		S_{21}		S_{12}		S_{22}	
	MAG	ANG	MAG	ANG	MAG	ANG	MAG	ANG
0.1	0.93	- 20	6.76	158	0.03	76	0.97	- 7
0.2	0.86	- 45	6.42	144	0.06	65	0.89	- 17
0.3	0.79	- 62	5.16	133	0.08	57	0.85	- 23
0.5	0.66	- 93	4.19	113	0.11	47	0.73	- 29
0.8	0.50	- 129	2.99	92	0.11	41	0.62	- 33
1.0	0.47	- 147	2.48	82	0.12	41	0.59	- 35
1.2	0.45	- 161	2.11	74	0.13	42	0.57	- 37
1.5	0.43	179	1.78	63	0.14	47	0.55	- 40
1.8	0.45	159	1.51	54	0.16	52	0.54	- 46
2.0	0.46	149	1.42	48	0.17	56	0.52	- 48

$I_C = 2 \text{ mA}, V_{CE} = 6 \text{ V}, Z_0 = 50 \Omega$

$S_{11}, S_{22} = f(f)$

$I_C = 2 \text{ mA}, V_{CE} = 6 \text{ V}, Z_0 = 50 \Omega$

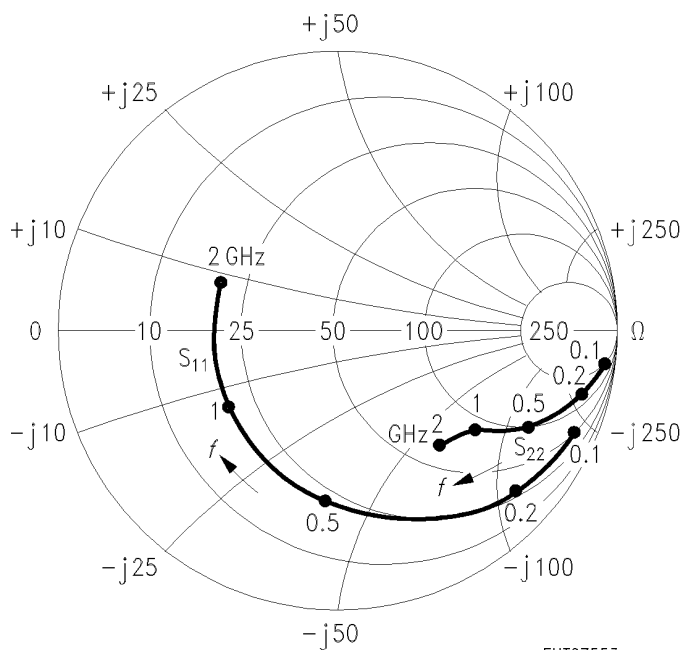

EHT07553

$S_{12}, S_{21} = f(f)$

$I_C = 2 \text{ mA}, V_{CE} = 6 \text{ V}, Z_0 = 50 \Omega$

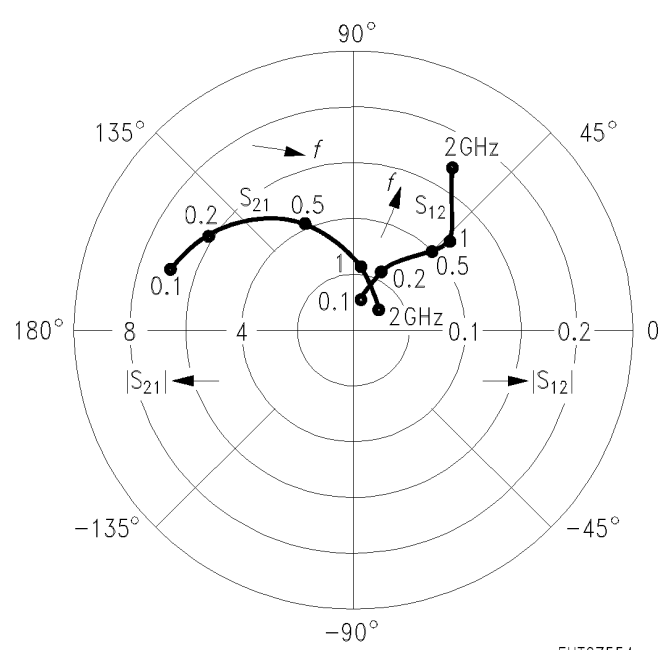

EHT07554

Common Emitter S Parameters (continued)

f	S_{11}		S_{21}		S_{12}		S_{22}	
	MAG	ANG	MAG	ANG	MAG	ANG	MAG	ANG
0.1	0.80	- 31	13.96	147	0.03	72	0.89	- 13
0.2	0.69	- 66	11.55	129	0.05	60	0.76	- 28
0.3	0.57	- 84	8.56	119	0.06	55	0.68	- 31
0.5	0.46	- 118	6.06	102	0.08	53	0.54	- 34
0.8	0.35	- 152	4.00	85	0.10	55	0.46	- 33
1.0	0.34	- 167	3.25	77	0.12	57	0.45	- 35
1.2	0.34	- 180	2.74	71	0.13	58	0.43	- 36
1.5	0.34	164	2.28	61	0.16	59	0.42	- 39
1.8	0.36	148	1.94	54	0.19	60	0.41	- 44
2.0	0.37	139	1.80	49	0.20	60	0.39	- 44

$I_C = 5 \text{ mA}, V_{CE} = 6 \text{ V}, Z_0 = 50 \Omega$

$S_{11}, S_{22} = f(f)$

$I_C = 5 \text{ mA}, V_{CE} = 6 \text{ V}, Z_0 = 50 \Omega$

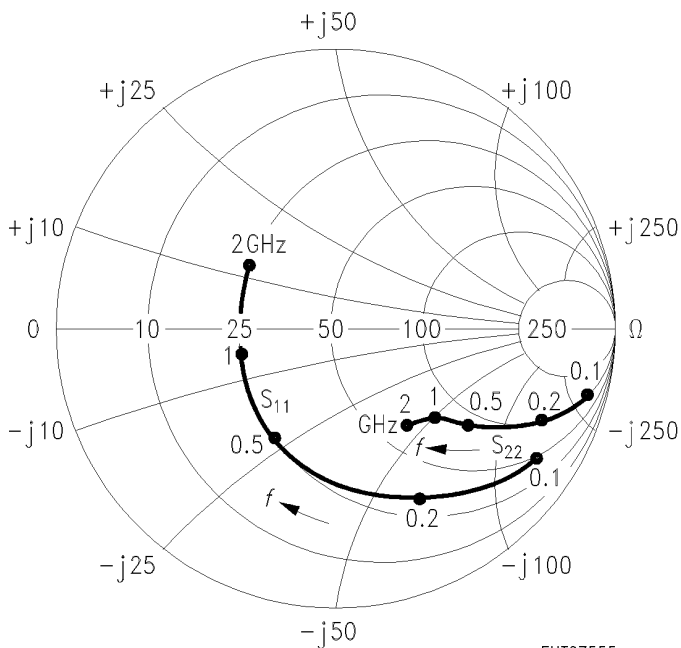

EHT07555

$S_{12}, S_{21} = f(f)$

$I_C = 5 \text{ mA}, V_{CE} = 6 \text{ V}, Z_0 = 50 \Omega$

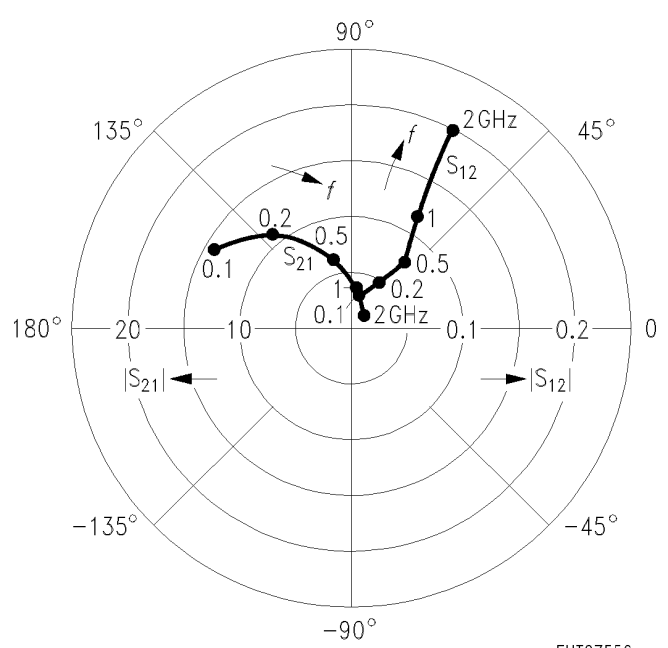

EHT07556

Common Emitter S Parameters (continued)

<i>f</i>	<i>S</i> ₁₁		<i>S</i> ₂₁		<i>S</i> ₁₂		<i>S</i> ₂₂	
	MAG	ANG	MAG	ANG	MAG	ANG	MAG	ANG
0.1	0.65	- 46	20.65	135	0.03	69	0.79	- 18
0.2	0.53	- 87	14.88	117	0.04	58	0.61	- 32
0.3	0.42	- 104	10.41	108	0.05	59	0.54	- 33
0.5	0.35	- 137	6.92	94	0.07	61	0.43	- 33
0.8	0.29	- 169	4.47	80	0.10	63	0.39	- 30
1.0	0.30	179	3.59	74	0.12	65	0.38	- 32
1.2	0.30	169	3.04	69	0.14	64	0.36	- 34
1.5	0.30	155	2.50	60	0.17	63	0.36	- 36
1.8	0.33	141	2.11	53	0.20	62	0.35	- 41
2.0	0.35	133	1.97	49	0.22	62	0.33	- 42

$I_C = 10 \text{ mA}, V_{CE} = 6 \text{ V}, Z_0 = 50 \Omega$

$S_{11}, S_{22} = f(f)$

$I_C = 10 \text{ mA}, V_{CE} = 6 \text{ V}, Z_0 = 50 \Omega$

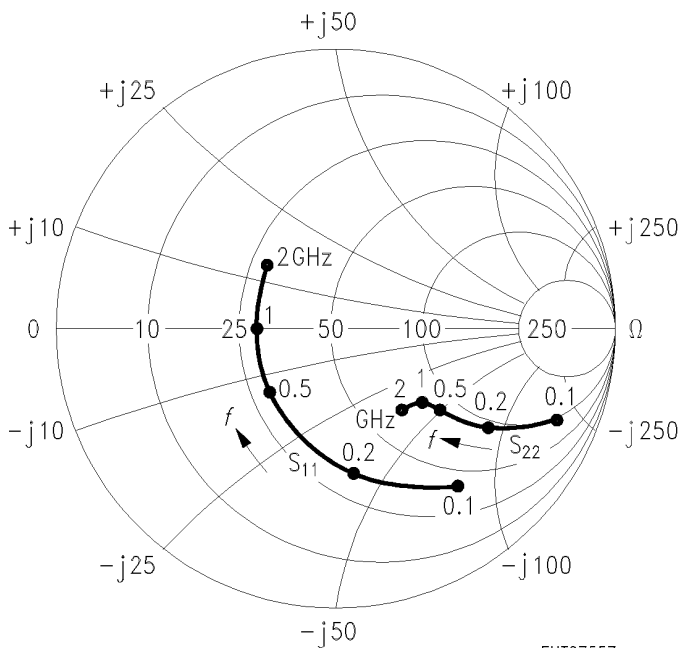

EHT07557

$S_{12}, S_{21} = f(f)$

$I_C = 10 \text{ mA}, V_{CE} = 6 \text{ V}, Z_0 = 50 \Omega$

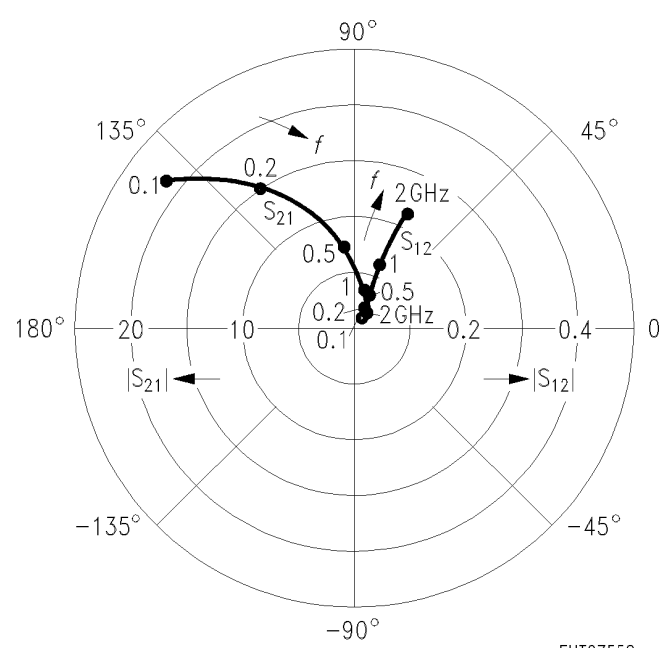

EHT07558

Common Emitter S Parameters (continued)

<i>f</i>	<i>S</i> ₁₁		<i>S</i> ₂₁		<i>S</i> ₁₂		<i>S</i> ₂₂	
	MAG	ANG	MAG	ANG	MAG	ANG	MAG	ANG
0.1	0.47	- 64	25.26	126	0.02	67	0.69	- 21
0.2	0.40	- 108	16.60	109	0.03	62	0.50	- 32
0.3	0.33	- 125	11.22	102	0.04	65	0.46	- 30
0.5	0.31	- 154	7.16	89	0.06	68	0.39	- 28
0.8	0.28	178	4.57	77	0.09	68	0.36	- 26
1.0	0.29	169	3.65	72	0.12	69	0.36	- 28
1.2	0.30	161	3.09	67	0.14	68	0.35	- 30
1.5	0.30	148	2.54	59	0.17	66	0.34	- 33
1.8	0.33	135	2.15	52	0.21	64	0.34	- 39
2.0	0.35	128	2.00	48	0.22	63	0.32	- 39

$I_C = 20 \text{ mA}, V_{CE} = 6 \text{ V}, Z_0 = 50 \Omega$

*S*₁₁, *S*₂₂ = *f* (*f*)

$I_C = 20 \text{ mA}, V_{CE} = 6 \text{ V}, Z_0 = 50 \Omega$

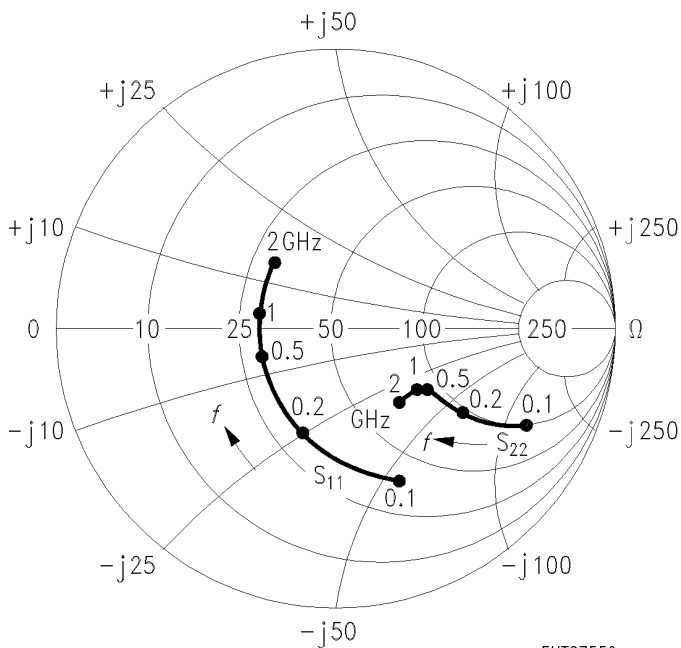

EHT07559

*S*₁₂, *S*₂₁ = *f* (*f*)

$I_C = 20 \text{ mA}, V_{CE} = 6 \text{ V}, Z_0 = 50 \Omega$

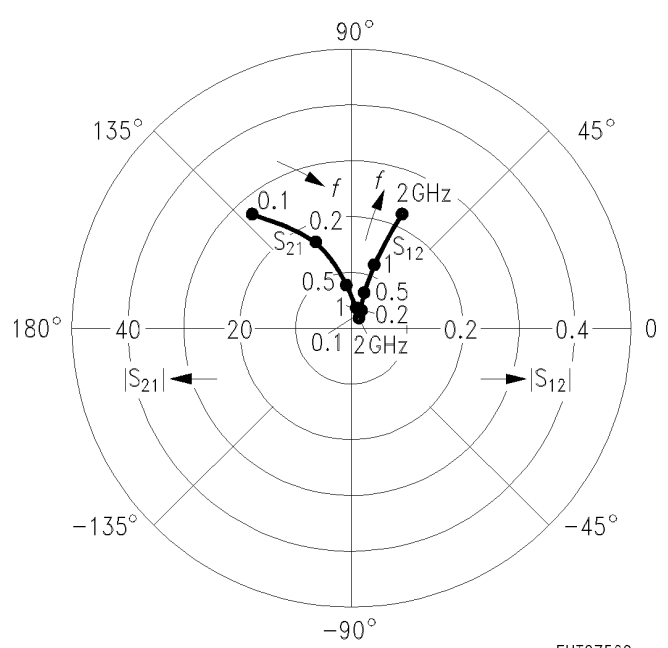

EHT07560