

DATA SHEET

BFQ221 NPN video transistor

Product specification
Supersedes data of 1996 July 18
File under Discrete Semiconductors, SC05

1996 Sep 04

NPN video transistor

BFQ221

APPLICATIONS

- Primarily intended for buffer stages in high resolution colour monitors.

DESCRIPTION

NPN silicon transistor encapsulated in a 3-lead plastic SOT54 package.

PINNING

PIN	DESCRIPTION
1	base
2	collector
3	emitter

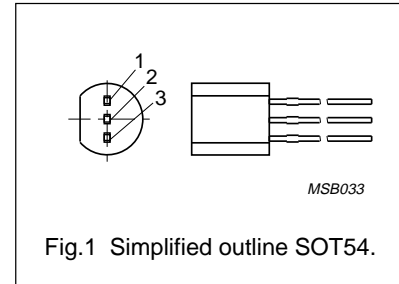

QUICK REFERENCE DATA

SYMBOL	PARAMETER	CONDITIONS	TYP	MAX	UNIT
V_{CBO}	collector-base voltage	open emitter	–	100	V
I_C	collector current (DC)		–	100	mA
P_{tot}	total power dissipation	up to $T_s = 60\text{ °C}$	–	1.15	W
f_T	transition frequency	$I_C = 25\text{ mA}$; $V_{CE} = 10\text{ V}$	1	–	GHz
C_{re}	feedback capacitance	$I_C = 0$; $V_{CB} = 10\text{ V}$	1.7	–	pF
T_j	junction temperature		–	150	°C

LIMITING VALUES

In accordance with the Absolute Maximum Rating System (IEC 134).

SYMBOL	PARAMETER	CONDITIONS	MIN	MAX	UNIT
V_{CBO}	collector-base voltage	open emitter	–	100	V
V_{CER}	collector-emitter voltage	$R_{BE} = 100\ \Omega$	–	95	V
V_{EBO}	emitter-base voltage	open collector	–	3	V
I_C	collector current (DC)	see Fig.2	–	100	mA
$I_{C(AV)}$	average collector current	see Fig.2	–	100	mA
P_{tot}	total power dissipation	up to $T_s = 60\text{ °C}$; note 1; see Fig.3	–	1.15	W
T_{stg}	storage temperature		–65	+150	°C
T_j	junction temperature		–	150	°C

Note

- T_s is the temperature at the soldering point of the collector pin.

NPN video transistor

BFQ221

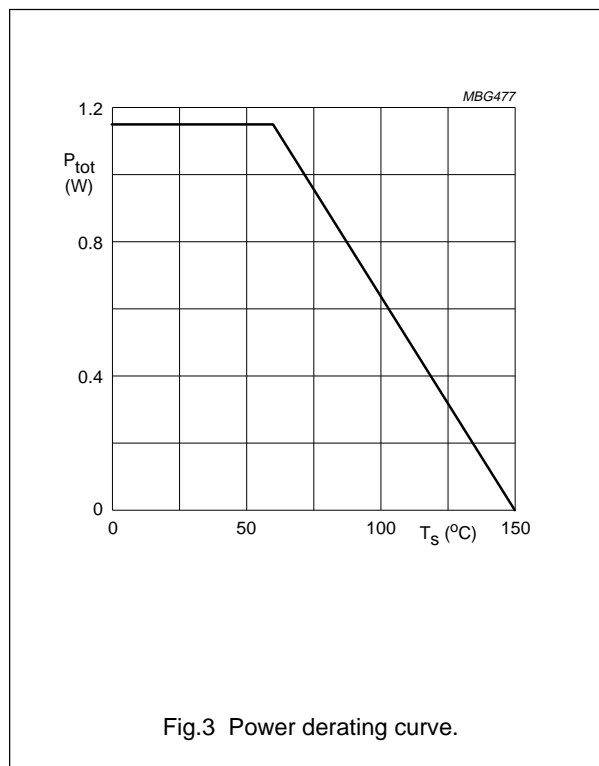
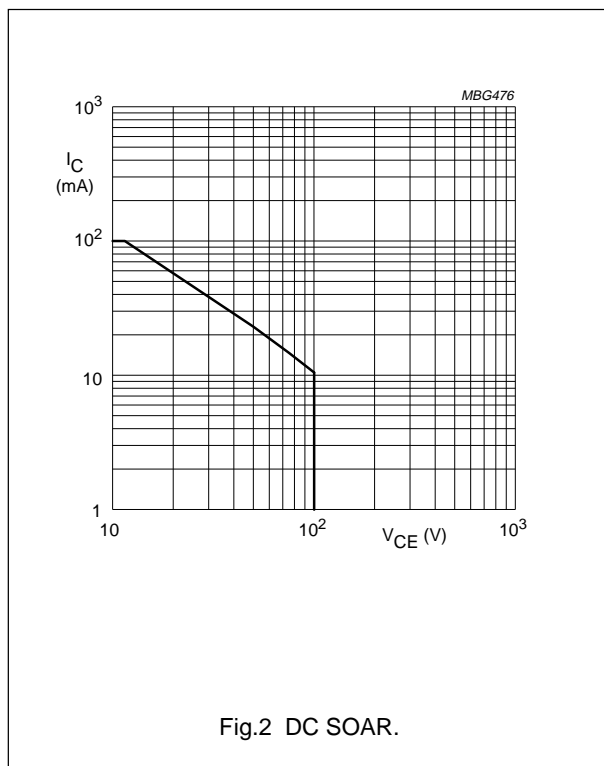

THERMAL CHARACTERISTICS

SYMBOL	PARAMETER	CONDITIONS	VALUE	UNIT
$R_{th\ j-s}$	thermal resistance from junction to soldering point	$P_{tot} = 1.15\text{ W}$; up to $T_s = 60\text{ °C}$; note 1	78	K/W

Note

- T_s is the temperature of the soldering point of the collector pin.

CHARACTERISTICS

$T_j = 25\text{ °C}$ unless otherwise specified.

SYMBOL	PARAMETER	CONDITIONS	MIN	TYP	MAX	UNIT
$V_{(BR)CBO}$	collector-base breakdown voltage	$I_C = 0.1\text{ mA}$; $I_E = 0$	100	–	–	V
$V_{(BR)CER}$	collector-emitter breakdown voltage	$I_C = 1\text{ mA}$; $R_{BE} = 100\ \Omega$	95	–	–	V
$V_{(BR)EBO}$	emitter-base breakdown voltage	$I_C = 0$; $I_E = 0.1\text{ mA}$	3	–	–	V
I_{CES}	collector-emitter leakage current	$V_{CE} = 50\text{ V}$; $V_{BE} = 0$	–	–	100	μA
h_{FE}	DC current gain	$I_C = 25\text{ mA}$; $V_{CE} = 10\text{ V}$; see Fig.4	20	–	–	
f_T	transition frequency	$I_C = 25\text{ mA}$; $V_{CE} = 10\text{ V}$; $f = 500\text{ MHz}$; see Fig.5	–	1	–	GHz
C_{re}	feedback capacitance	$I_C = 0$; $V_{CB} = 10\text{ V}$; $f = 1\text{ MHz}$; see Fig.6	–	1.7	–	pF

NPN video transistor

BFQ221

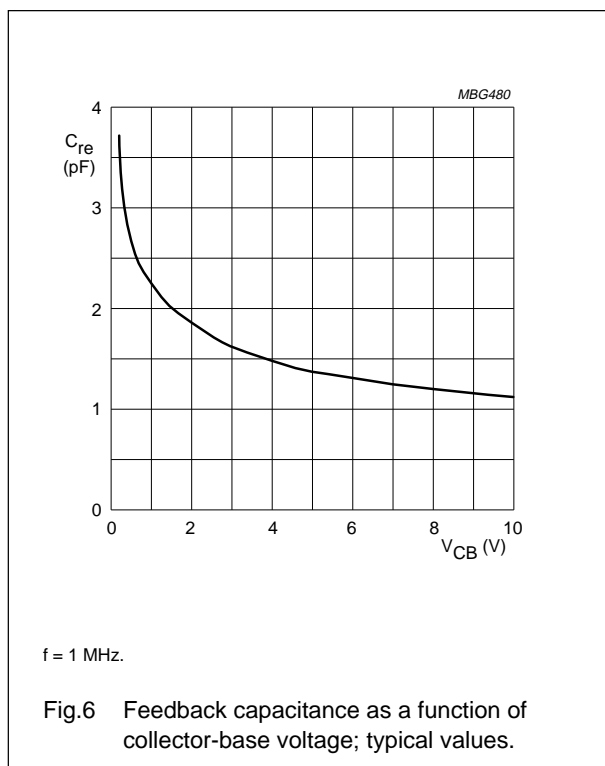
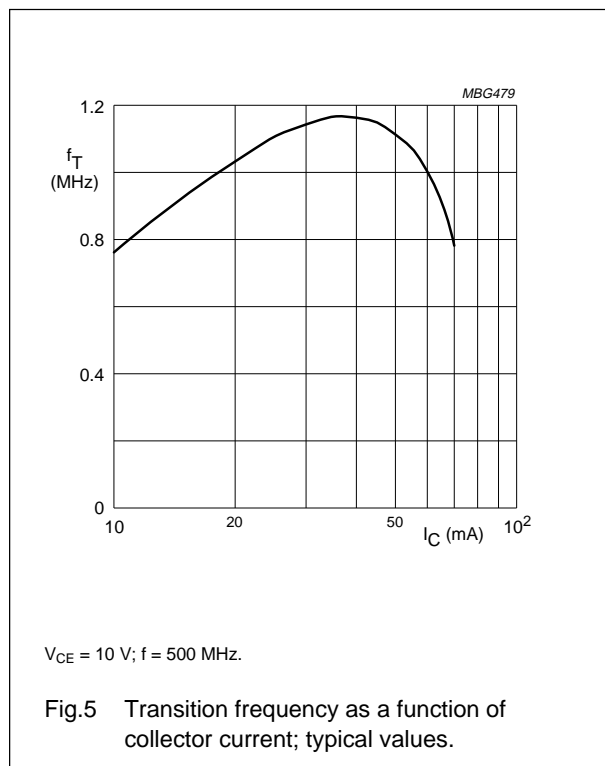
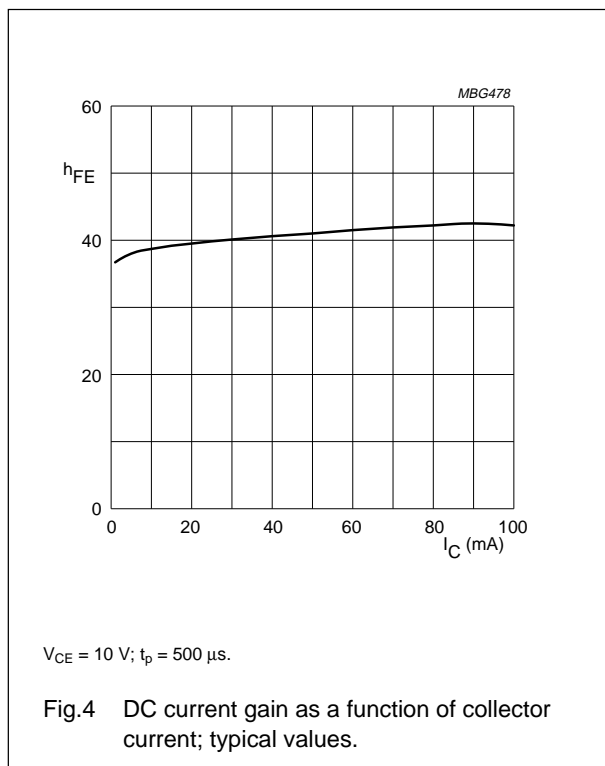

NPN video transistor

BFQ221

PACKAGE OUTLINE

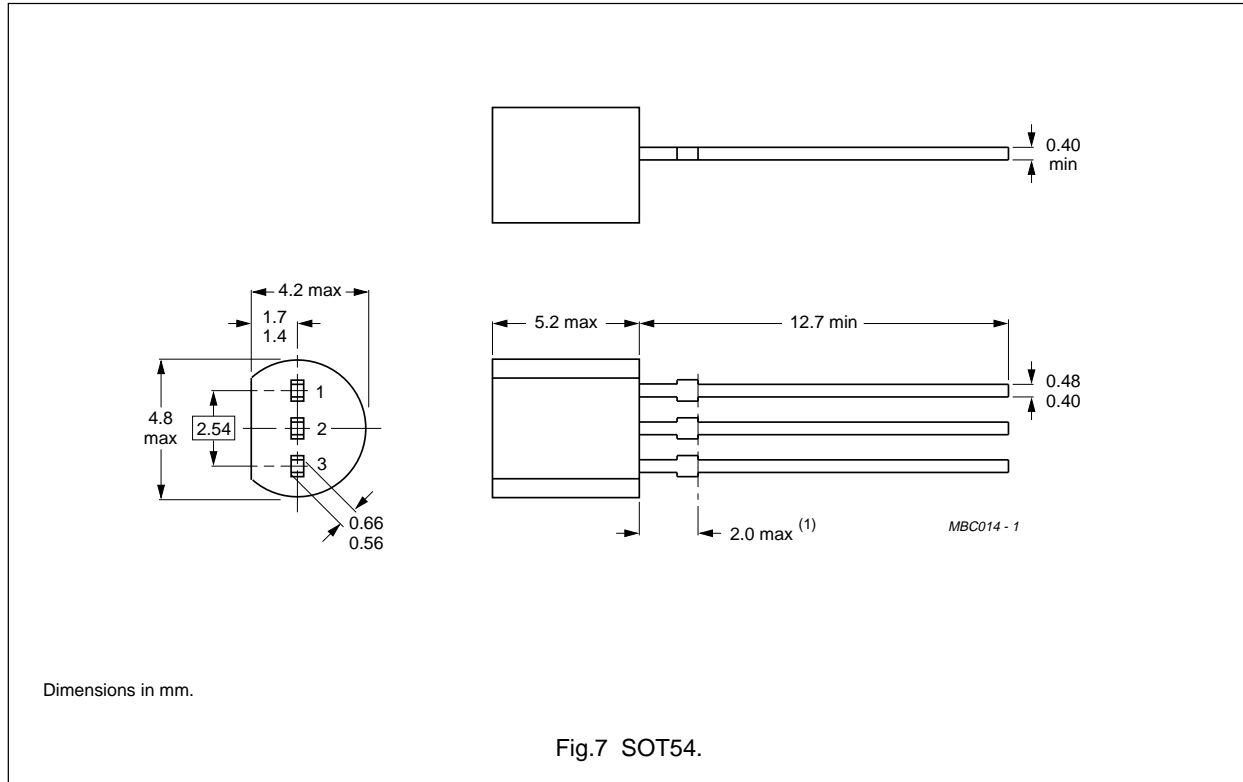

DEFINITIONS

Data Sheet Status	
Objective specification	This data sheet contains target or goal specifications for product development.
Preliminary specification	This data sheet contains preliminary data; supplementary data may be published later.
Product specification	This data sheet contains final product specifications.
Limiting values	
Limiting values given are in accordance with the Absolute Maximum Rating System (IEC 134). Stress above one or more of the limiting values may cause permanent damage to the device. These are stress ratings only and operation of the device at these or at any other conditions above those given in the Characteristics sections of the specification is not implied. Exposure to limiting values for extended periods may affect device reliability.	
Application information	
Where application information is given, it is advisory and does not form part of the specification.	

LIFE SUPPORT APPLICATIONS

These products are not designed for use in life support appliances, devices, or systems where malfunction of these products can reasonably be expected to result in personal injury. Philips customers using or selling these products for use in such applications do so at their own risk and agree to fully indemnify Philips for any damages resulting from such improper use or sale.