

Silicon PNP Power Transistors

2SA1096 2SA1096A

DESCRIPTION

- With TO-126 package
- Complement to type 2SC2497/2SC2497A

APPLICATIONS

- For low-frequency power amplification

PINNING

PIN	DESCRIPTION
1	Emitter
2	Collector;connected to mounting base
3	Base

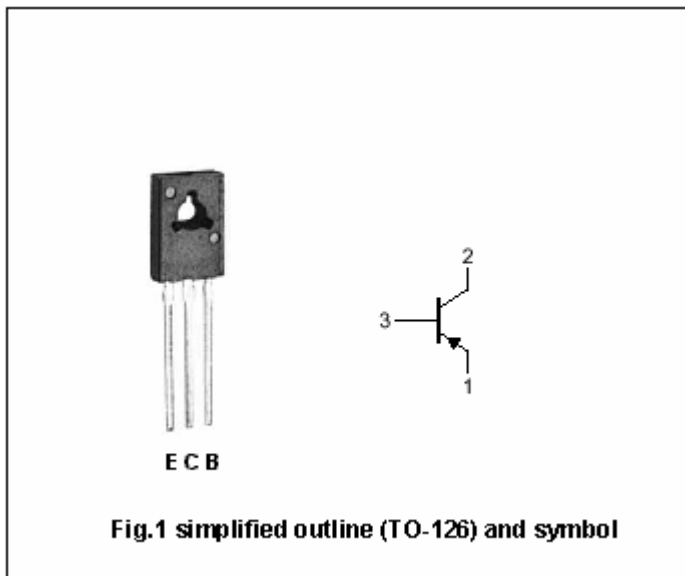

Absolute maximum ratings(Ta=25°C)

SYMBOL	PARAMETER	CONDITIONS	VALUE	UNIT
V _{CB0}	Collector-base voltage	Open emitter	-70	V
V _{CEO}	Collector- emitter voltage	2SA1096	-50	V
		2SA1096A	-60	
V _{EBO}	Emitter-base voltage	Open collector	-5	V
I _C	Collector current		-2	A
I _{CM}	Collector current-peak		-3	A
P _D	Total power dissipation	T _C =25°C	1.2 ^{*1}	W
			5 ^{*2}	
T _j	Junction temperature		150	°C
T _{stg}	Storage temperature		-55°C+150	°C

Note) *1: Without heat sink

*2: With a 100 × 100 × 2 mm A1 heat sink

Silicon PNP Power Transistors

2SA1096 2SA1096A

CHARACTERISTICS

T_j=25°C unless otherwise specified

SYMBOL	PARAMETER	CONDITIONS	MIN	TYP.	MAX	UNIT	
V _{(BR)CEO}	Collector-emitter breakdown voltage	2SA1096	I _C =-2mA ; I _B =0	-50			V
		2SA1096A		-60			
V _{(BR)CBO}	Collector-base breakdown voltage	I _C =-1mA ; I _E =0	-70			V	
V _{CEsat}	Collector-emitter saturation voltage	I _C =-1.5A ; I _B =-0.15A			-1.0	V	
V _{BEsat}	Base-emitter saturation voltage	I _C =-1.5A ; I _B =-0.15A			-1.5	V	
I _{CEO}	Collector cut-off current	V _{CE} =-10V ; I _B =0			-1	μA	
I _{CBO}	Collector cut-off current	V _{CB} =-20V ; I _E =0			-100	μA	
I _{EBO}	Emitter cut-off current	V _{EB} =-5V ; I _C =0			-10	μA	
h _{FE}	DC current gain	I _C =-1A ; V _{CE} =-5V	80		220		
C _{OB}	Output capacitance	I _E =0 ; V _{CB} =-20V, f=1MHz		55		pF	
f _T	Transition frequency	I _E =-0.5A ; V _{CB} =-5V, f=200MHz		150		MHz	

◆ h_{FE} Classifications

Q	R
80-160	120-220

Silicon PNP Power Transistors

2SA1096 2SA1096A

PACKAGE OUTLINE

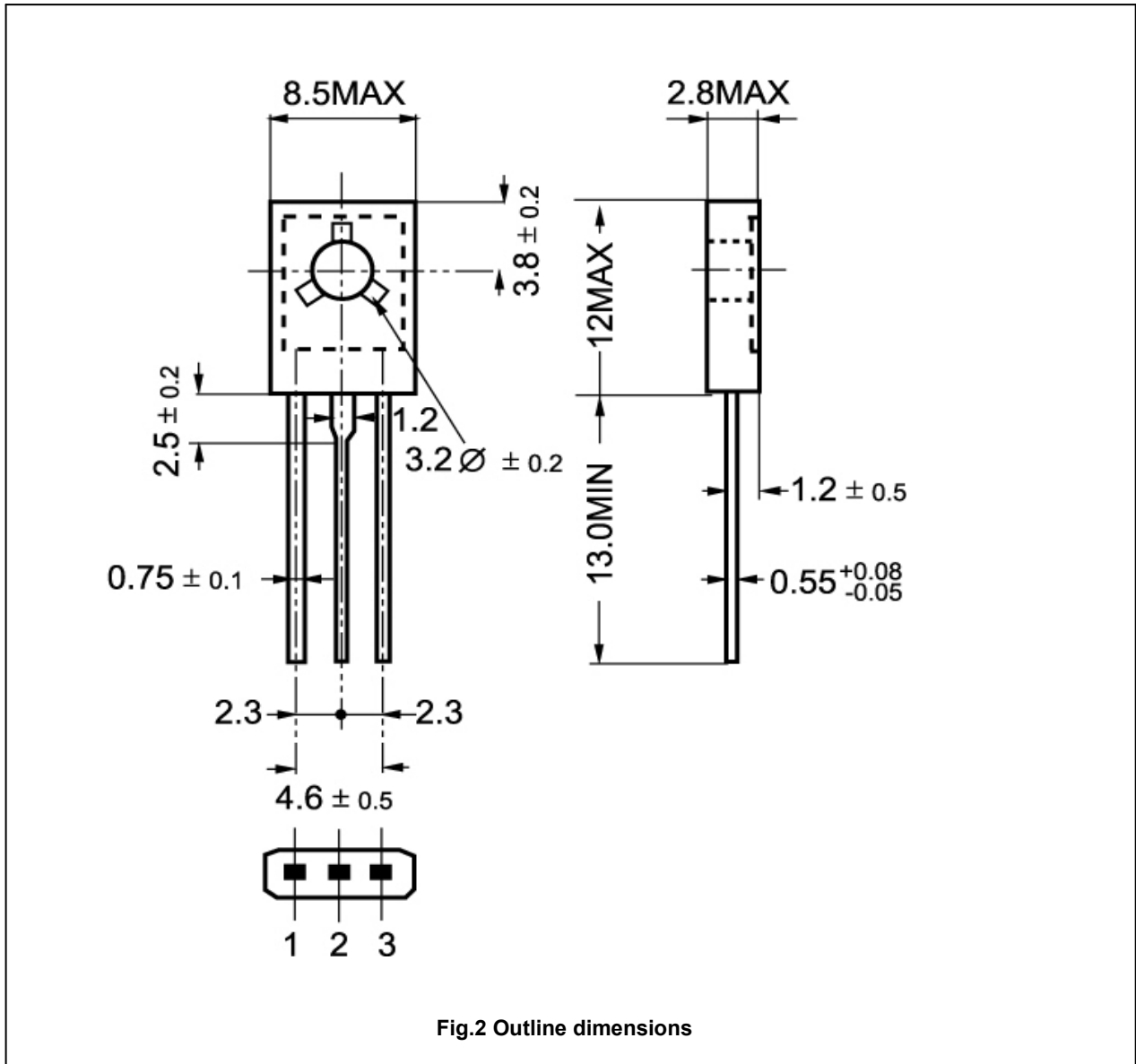
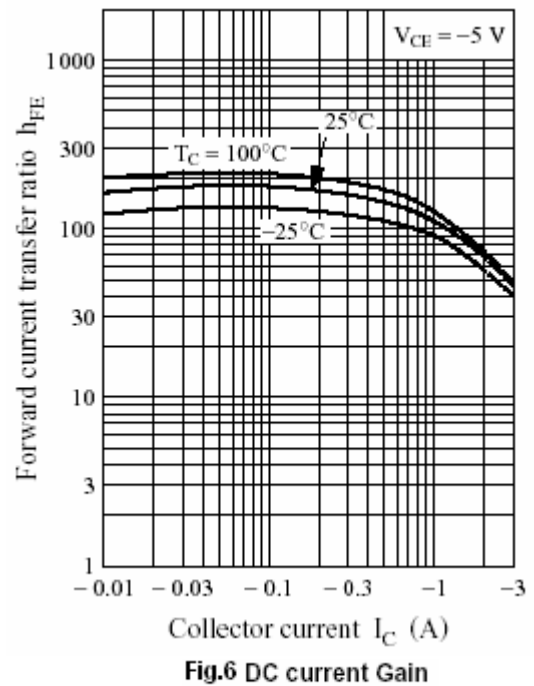
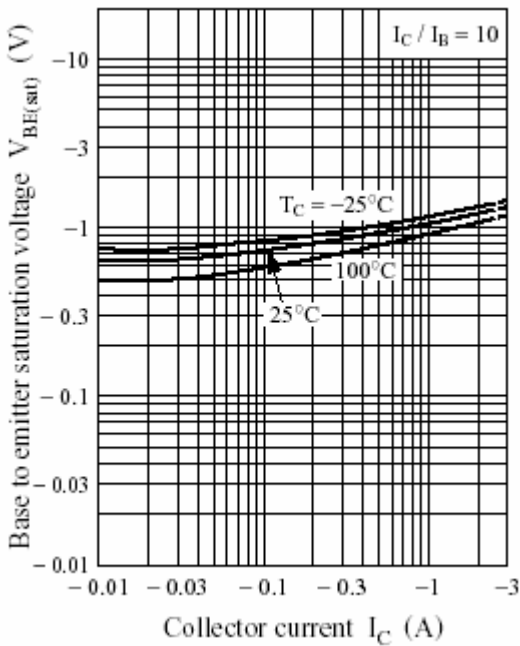
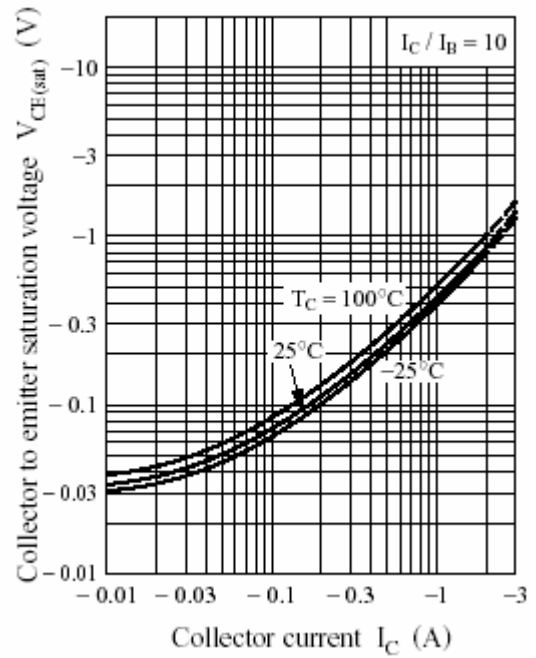
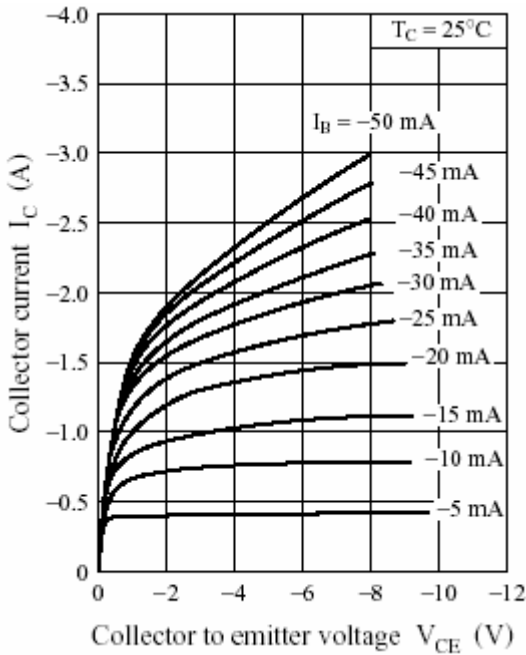

Fig.2 Outline dimensions

Silicon PNP Power Transistors

2SA1096 2SA1096A



Silicon PNP Power Transistors

2SA1096 2SA1096A

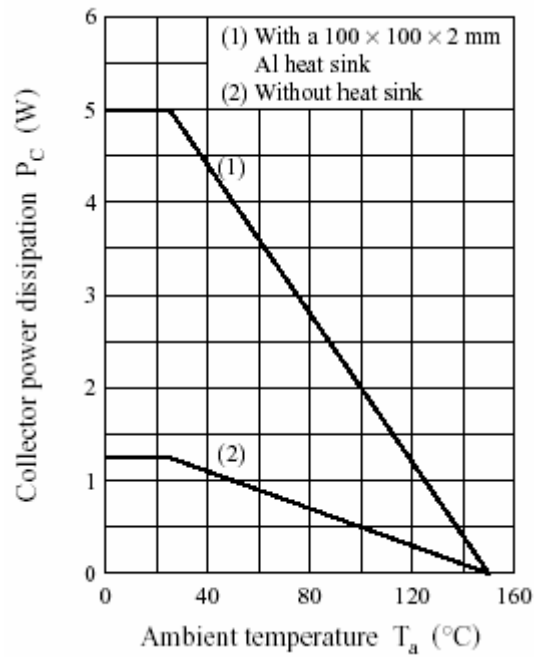

Fig.7 Power Derating

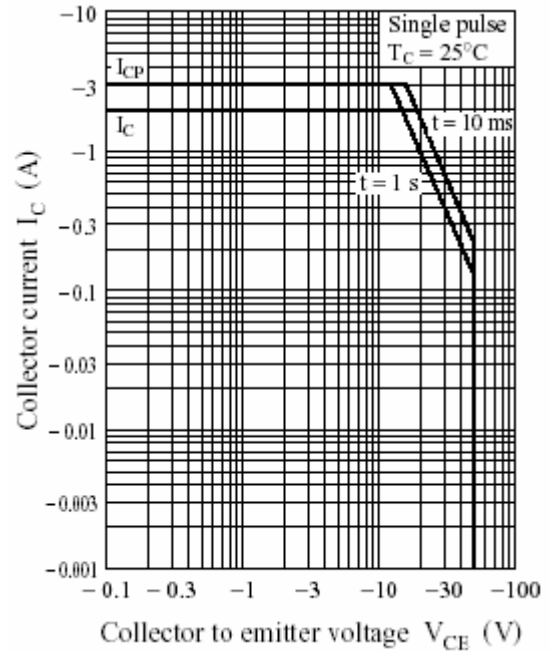

Fig.8 Safe Operating Area