

100mW High Power Laser Diode

Description

The SLD301XT allows independent thermal and electric design. This laser diode has a built-in TE (Thermo Electric) cooler.

Features

- High power
Recommended optical power output $P_o = 90\text{mW}$
- Low operating current
- Flat Package with built-in photodiode, TE cooler and thermistor

Applications

- Solid state laser excitation
- Medical use

Structure

AlGaAs double-hetero-type laser diode

Operating Lifetime

MTTF 10,000H (effective value) at $P_o = 90\text{mW}$, $T_{th} = 25^\circ\text{C}$

Absolute Maximum Ratings ($T_{th} = 25^\circ\text{C}$)

- | | | | | |
|--------------------------------------|-----------|------------|----|----|
| • Optical power output | P_o | 100 | | mW |
| • Reverse voltage | V_R | LD | 2 | V |
| | | PD | 15 | V |
| • Operating temperature (T_{th}) | T_{opr} | -10 to +50 | | °C |
| • Storage temperature | T_{stg} | -40 to +85 | | °C |

Warranty

This warranty period shall be 90 days after receipt of the product or 1,000 hours operation time whichever is shorter.

Sony Quality Assurance Department shall analyze any product that fails during said warranty period, and if the analysis results show that the product failed due to material or manufacturing defects on the part of Sony, the product shall be replaced free of charge.

Laser diodes naturally have differing lifetimes which follow a Weibull distribution.

Special warranties are also available.

Equivalent Circuit

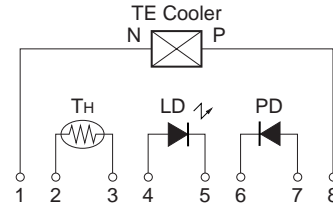

Pin Configuration (Top View)

No.	Function
1	TE cooler (negative)
2	Thermistor lead 1
3	Thermistor lead 2
4	Laser diode (anode)
5	Laser diode (cathode)
6	Photodiode (cathode)
7	Photodiode (anode)
8	TE cooler (positive)

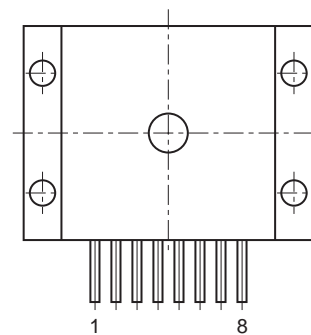

Sony reserves the right to change products and specifications without prior notice. This information does not convey any license by any implication or otherwise under any patents or other right. Application circuits shown, if any, are typical examples illustrating the operation of the devices. Sony cannot assume responsibility for any problems arising out of the use of these circuits.

Electrical and Optical Characteristics

(T_{th}: Thermistor temperature, T_{th} = 25°C)

Item	Symbol	Conditions	Min.	Typ.	Max.	Unit
Threshold current	I _{th}			150	200	mA
Operating current	I _{op}	P _O = 90mW		250	400	mA
Operating voltage	V _{op}	P _O = 90mW		1.9	3.0	V
Wavelength*	λ _p	P _O = 90mW	770		840	nm
Monitor current	I _{mon}	P _O = 90mW V _R = 10V		0.15		mA
Radiation angle	Perpendicular	θ _⊥	P _O = 90mW	28	40	degree
	Parallel	θ _{//}		12	17	degree
Positional accuracy	Position	ΔX, ΔY	P _O = 90mW		±100	μm
	Angle	Δφ _⊥			±3	degree
Differential efficiency	η _D	P _O = 90mW	0.65	0.9		mW/mA
Thermistor resistance	R _{th}	T _{th} = 25°C		10		kΩ

*** Wavelength Selection Classification**

Type	Wavelength (nm)
SLD301XT-1	785 ± 15
SLD301XT-2	810 ± 10
SLD301XT-3	830 ± 10

Type	Wavelength (nm)
SLD301XT-21	798 ± 3
SLD301XT-24	807 ± 3
SLD301XT-25	810 ± 3

Handling Precautions

Eye protection against laser beams

The optical output of laser diodes ranges from several mW to 1W. However the optical power density of the laser beam at the diode chip reaches 1mW/cm². Unlike gas lasers, since laser diode beams are divergent, uncollimated laser diode beams are fairly safe at a laser diode. For observing laser beams, ALWAYS use safety goggles that block infrared rays. Usage of IR scopes, IR cameras and fluorescent plates is also recommended for monitoring laser beams safely.

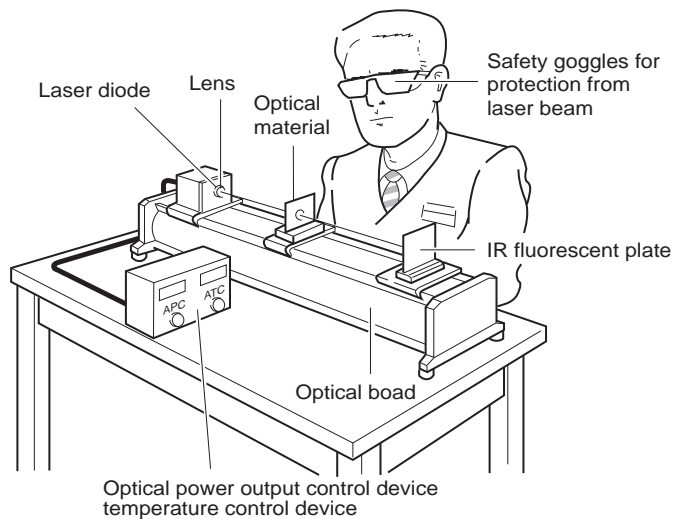

Example of Representative Characteristics

Optical power output vs. Forward current characteristics

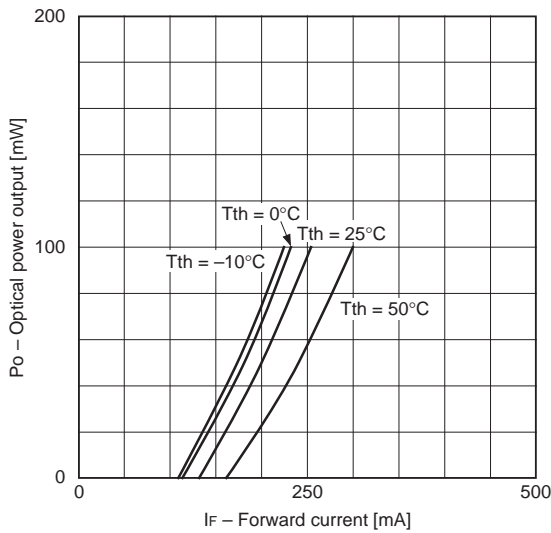

Optical power output vs. Monitor current characteristics

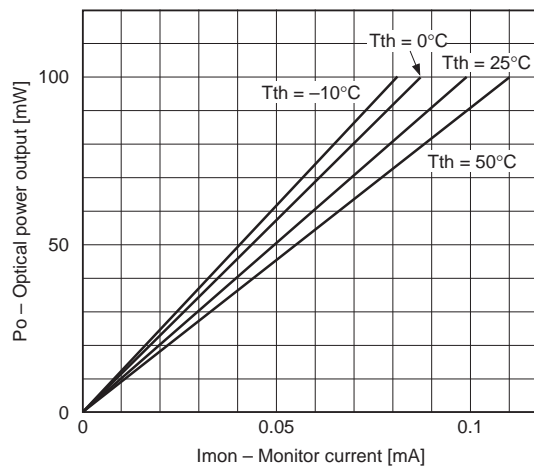

Threshold current vs. Temperature characteristics

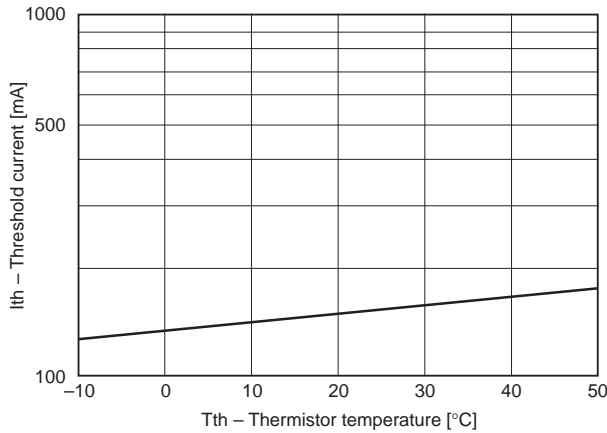

Power dependence of far field pattern (parallel to junction)

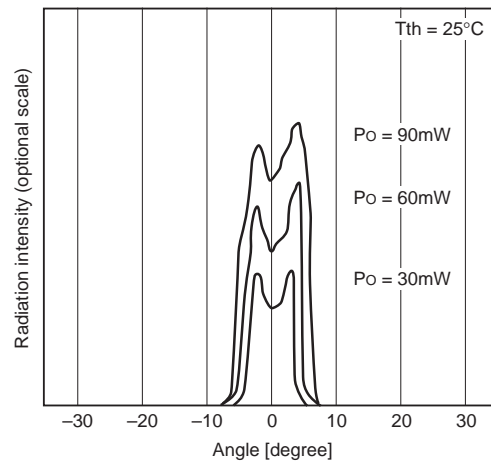

Power dependence of near field pattern

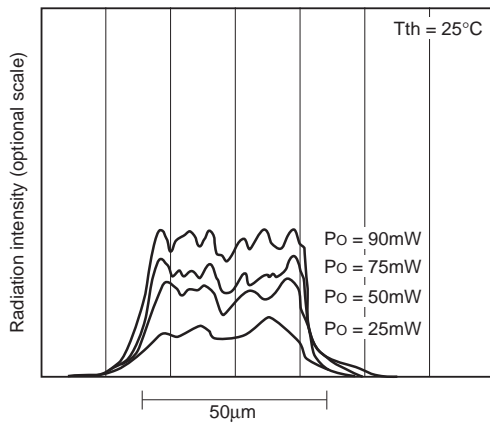

Oscillation wavelength vs. Temperature characteristics

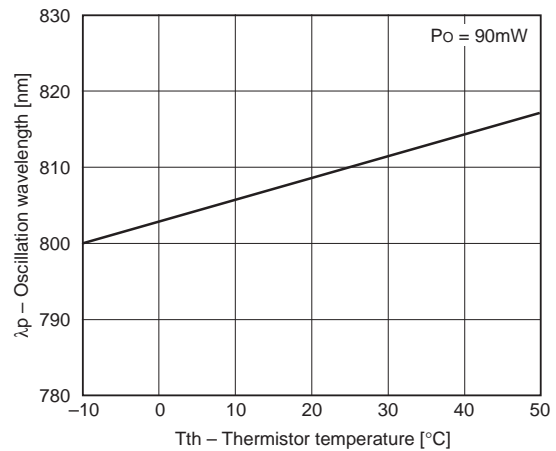

Differential efficiency vs. Temperature characteristics

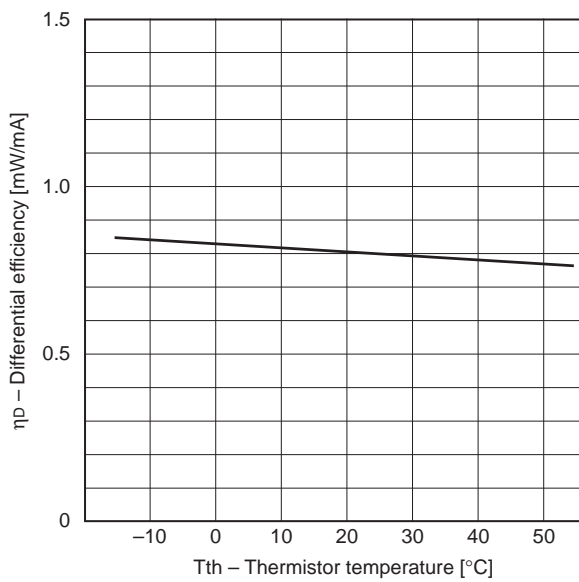

Power dependence of polarization ratio

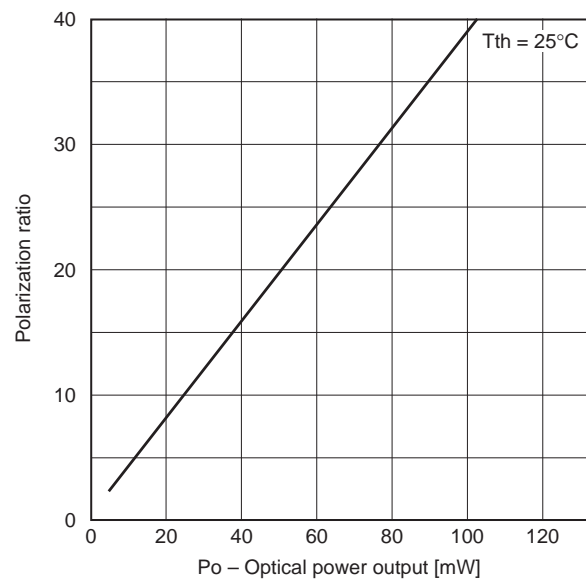

Power dependence of wavelength

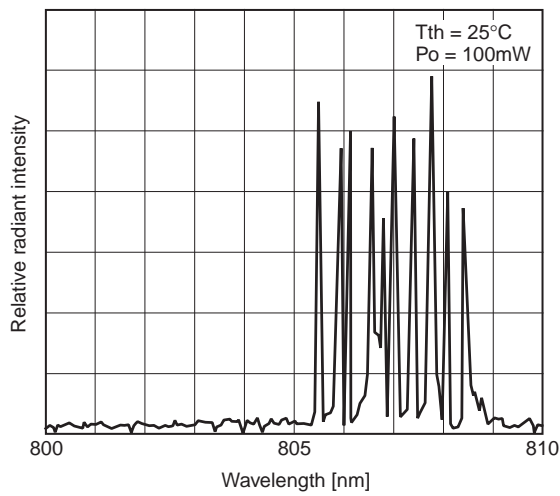
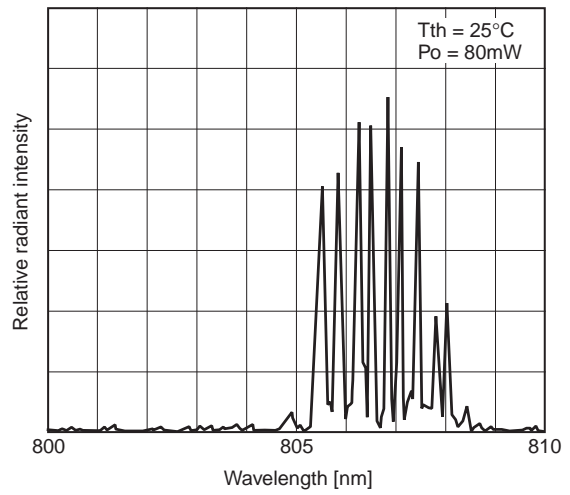
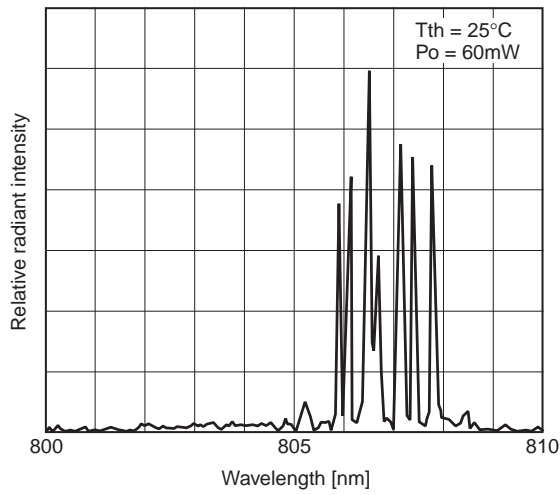
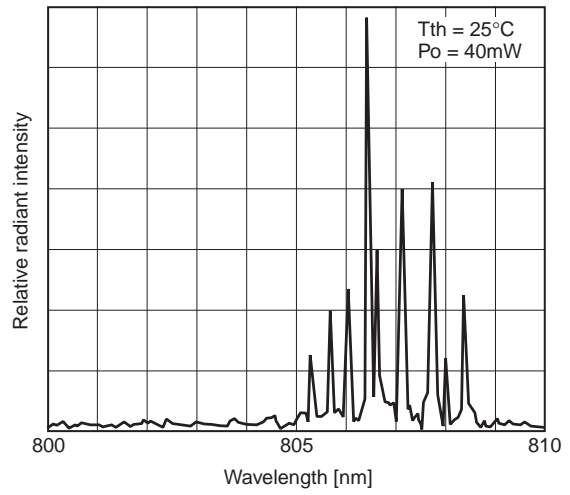
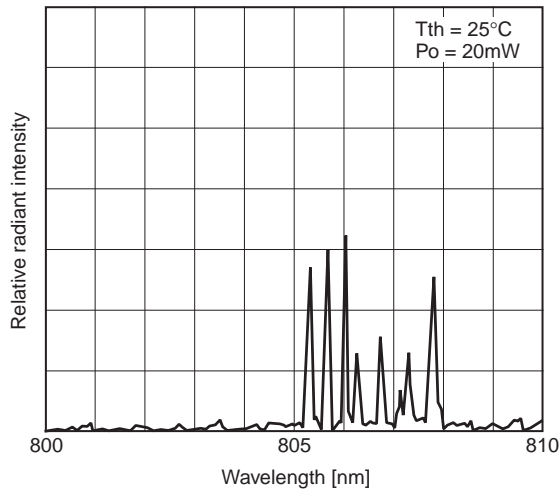

Temperature dependence of wavelength ($P_o = 90\text{mW}$)

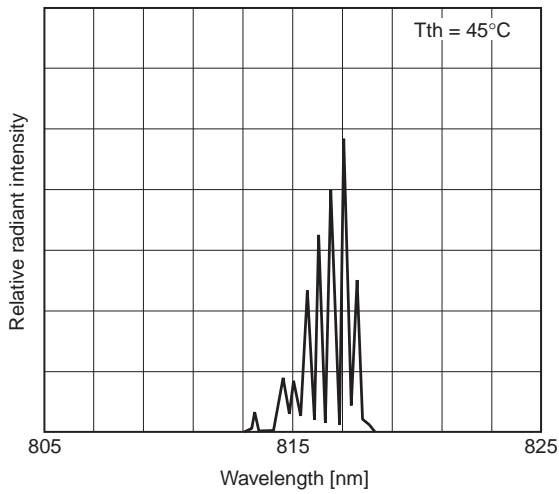
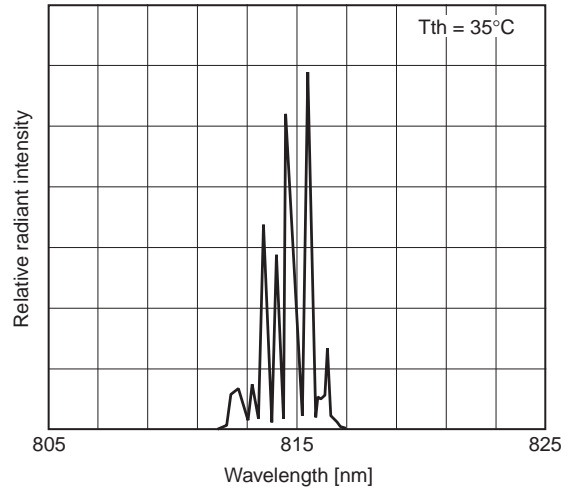
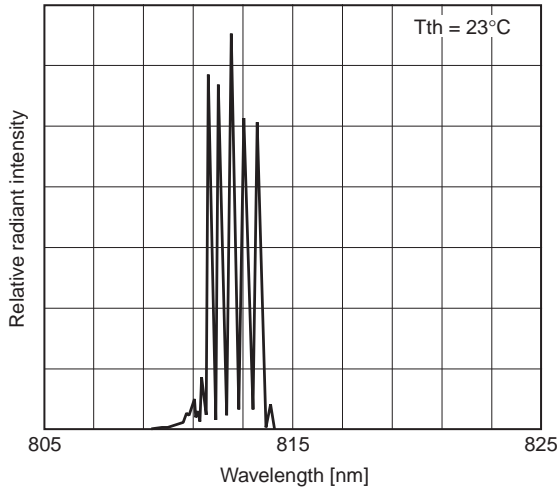
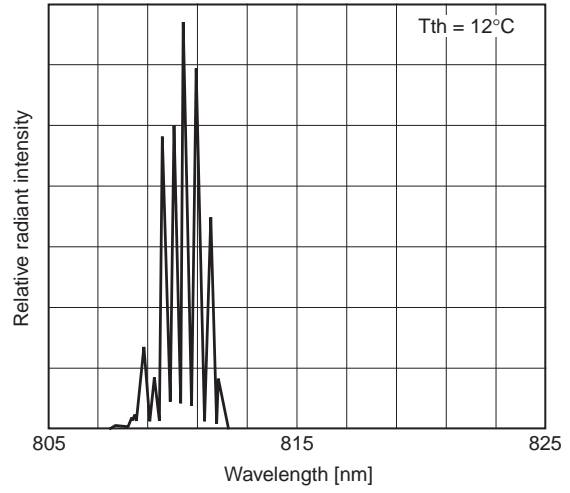
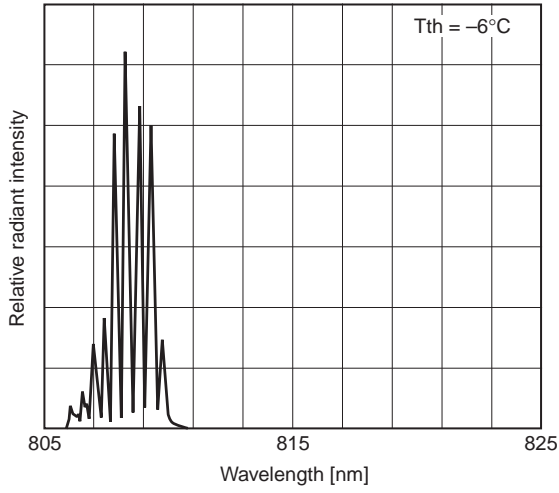

TE cooler characteristics

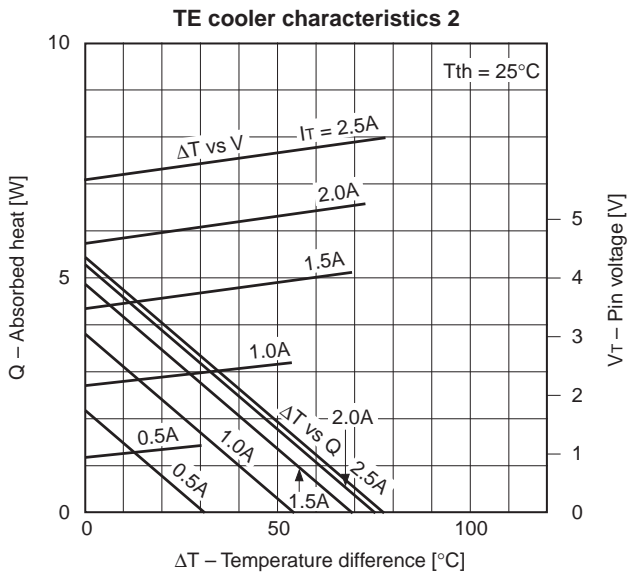
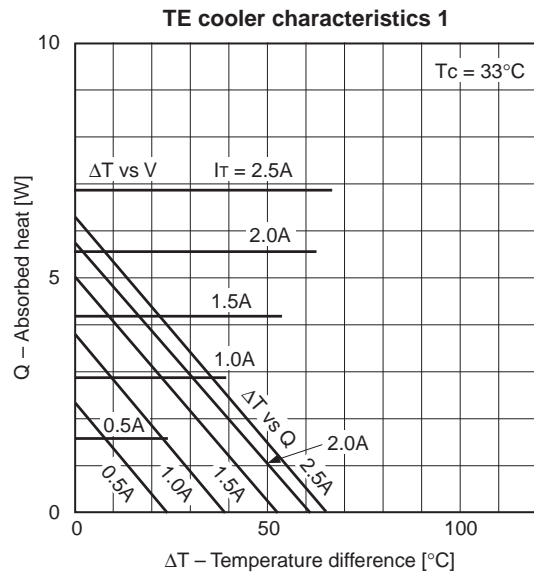

ΔT : $T_c - T_{th}$
 T_{th} : Thermistor temperature
 T_c : Case temperature

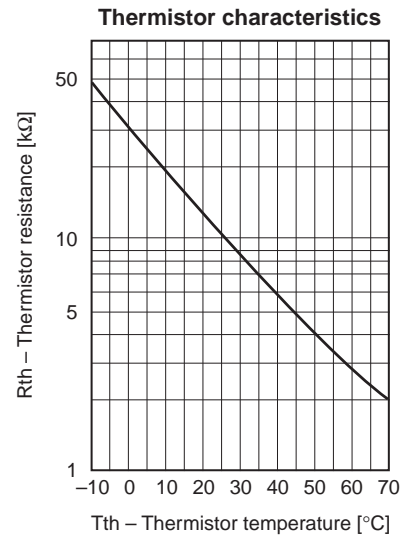

Package Outline

Unit: mm

M-273(LO-10)

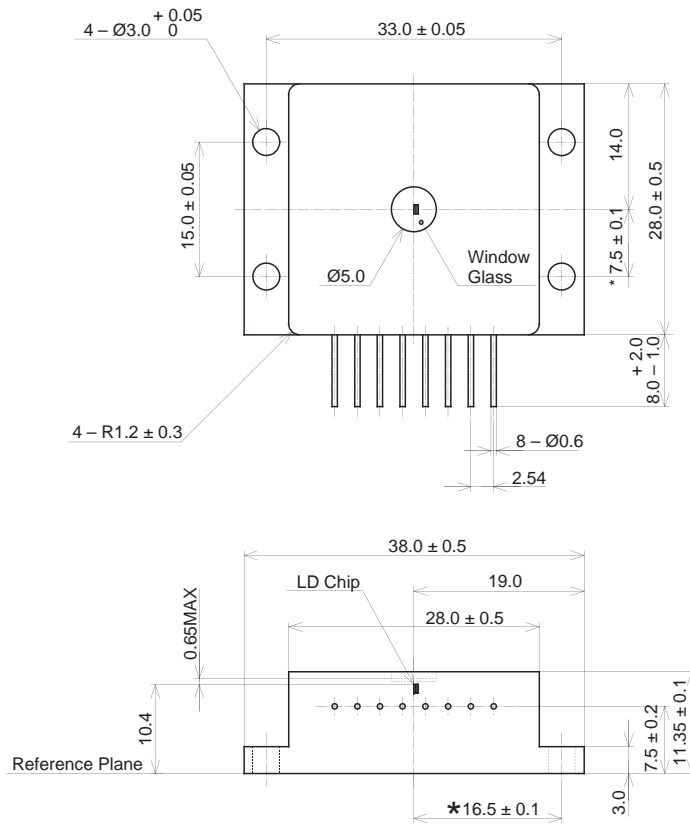

*Distance between pilot hole and emitting area

PACKAGE STRUCTURE

SONY CODE	M-273(LO-10)
EIAJ CODE	_____
JEDEC CODE	_____

PACKAGE WEIGHT	43g
----------------	-----