

PTF 10111

6 Watts, 1.5 GHz

GOLDMOS™ Field Effect Transistor

Description

The PTF 10111 is a 6 watt LDMOS FET intended for large signal amplifier applications to 1.5 GHz. It operates @ 50% efficiency and 16 dB of gain. Nitride surface passivation and full gold metallization ensure excellent device lifetime and reliability.

- **Performance at 1.5 GHz, 28 Volts**
 - Output Power = 6 Watts
 - Efficiency = 50% Typ
 - Power Gain = 16 dB Typ
- **Full Gold Metallization**
- **Silicon Nitride Passivated**
- **100% Lot Traceability**

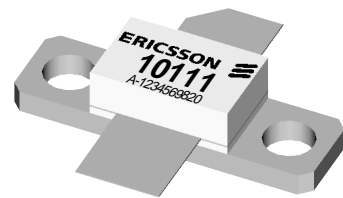
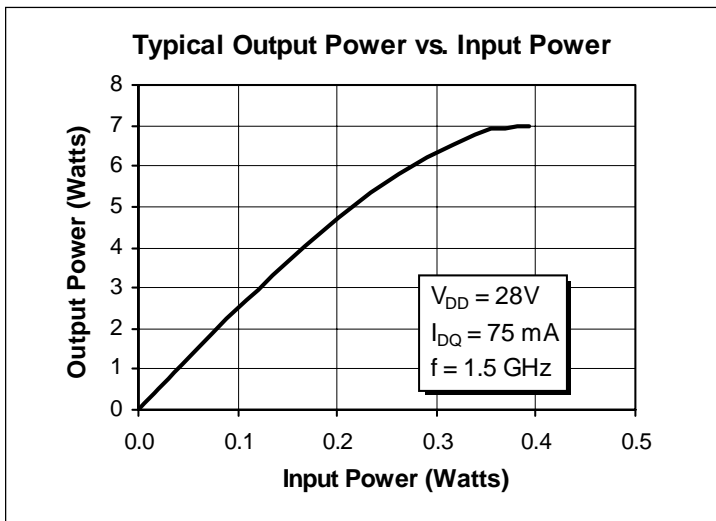

Package 20222

Maximum Ratings

Parameter	Symbol	Value	Unit
Drain-Source Voltage	V_{DSS}	65	Vdc
Gate-Source Voltage	V_{GS}	± 20	Vdc
Operating Junction Temperature	T_J	200	$^{\circ}C$
Total Device Dissipation at $T_{flange} = 25^{\circ}C$ Above $25^{\circ}C$ derate by	P_D	36 0.208	Watts $W/^{\circ}C$
Storage Temperature Range	T_{STG}	-40 to +150	$^{\circ}C$
Thermal Resistance ($T_{flange} = 70^{\circ}C$)	$R_{\theta JC}$	4.8	$^{\circ}C/W$

Electrical Characteristics (100% Tested)

Characteristic	Conditions	Symbol	Min	Typ	Max	Units
Drain-Source Breakdown Voltage	$V_{GS} = 0\text{ V}, I_D = 40\text{ mA}$	$V_{(BR)DSS}$	65	68	—	Volts
Drain-Source Leakage Current	$V_{DS} = 28\text{ V}, V_{GS} = 0\text{ V}$	I_{DSS}	—	—	1	mA
Gate Threshold Voltage	$V_{DS} = 10\text{ V}, I_D = 75\text{ mA}$	$V_{GS(th)}$	3.0	—	5.0	Volts
Forward Transconductance	$V_{DS} = 10\text{ V}, I_D = 0.5\text{ A}$	g_{fs}	—	0.2	—	Siemens

RF Specifications (100% Tested)

Characteristic	Symbol	Min	Typ	Max	Units
Common Source Power Gain ($V_{DD} = 28\text{ V}, P_{OUT} = 6\text{ W}, I_{DQ} = 75\text{ mA}, f = 1.5\text{ GHz}$)	G_{ps}	15.0	16	—	dB
Power Output at 1 dB Compressed ($V_{DD} = 28\text{ V}, I_{DQ} = 75\text{ mA}, f = 1.5\text{ GHz}$)	P-1dB	6	7	—	Watts
Drain Efficiency ($V_{DD} = 28\text{ V}, P_{OUT} = 6\text{ W}, I_{DQ} = 75\text{ mA}, f = 1.5\text{ GHz}$)	η_D	45	50	—	%
Load Mismatch Tolerance ($V_{DD} = 28\text{ V}, P_{OUT} = 6\text{ W}, I_{DQ} = 75\text{ mA}, f = 1.5\text{ GHz}$ — all phase angles at frequency of test)	Ψ	—	—	30:1	—

Typical Performance

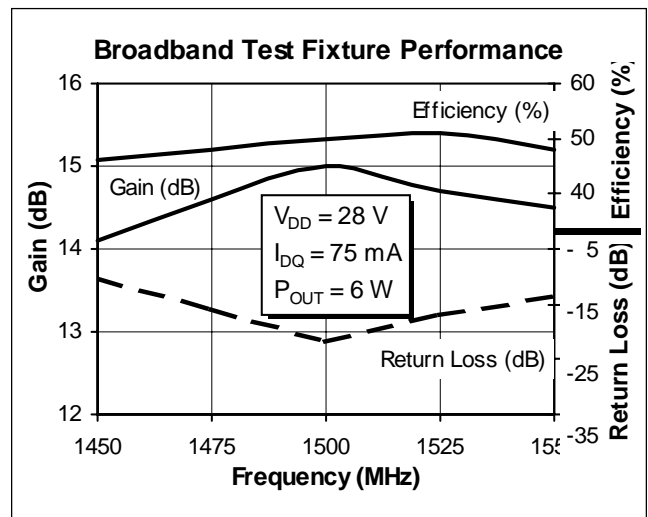
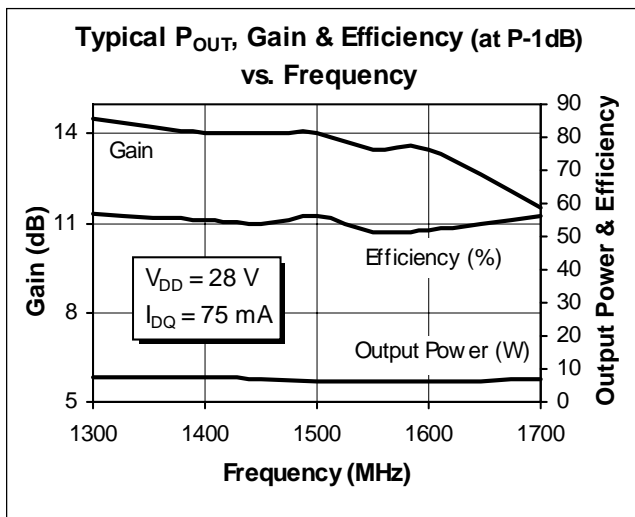

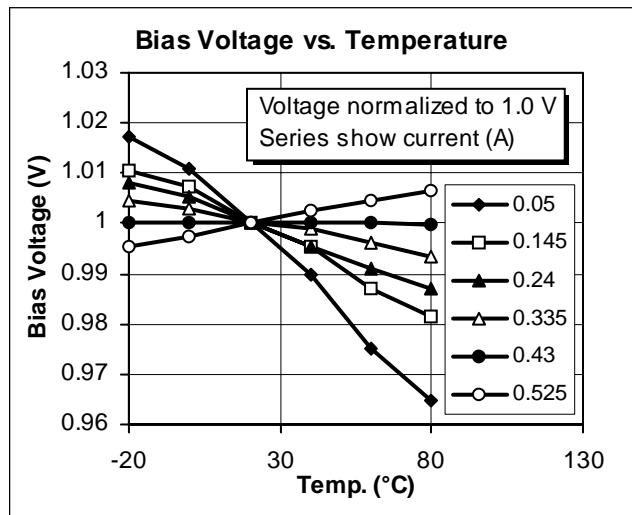
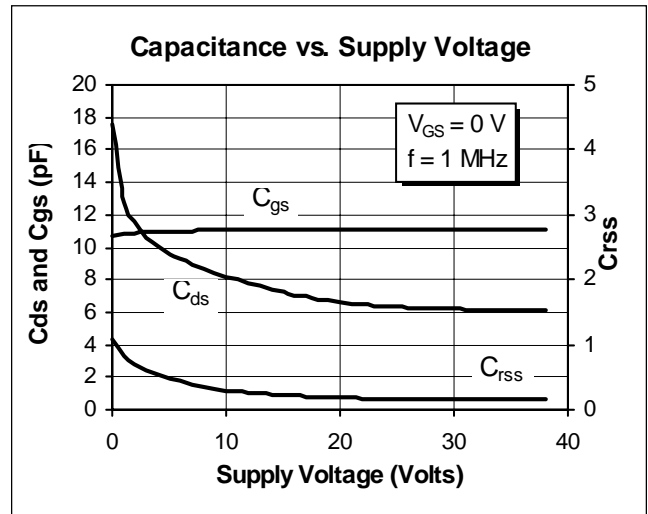
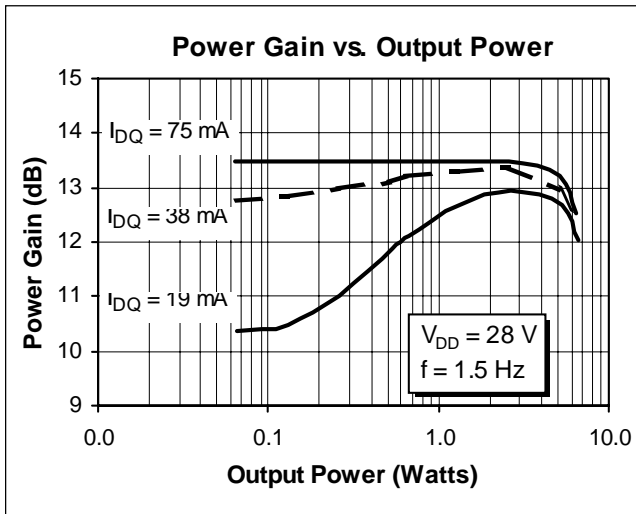
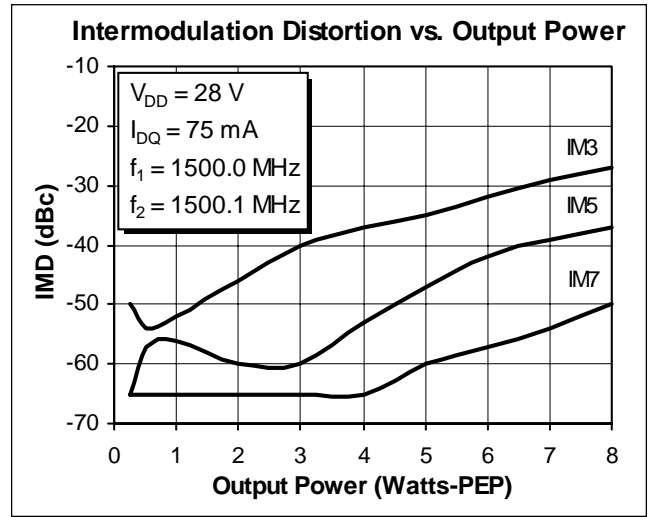
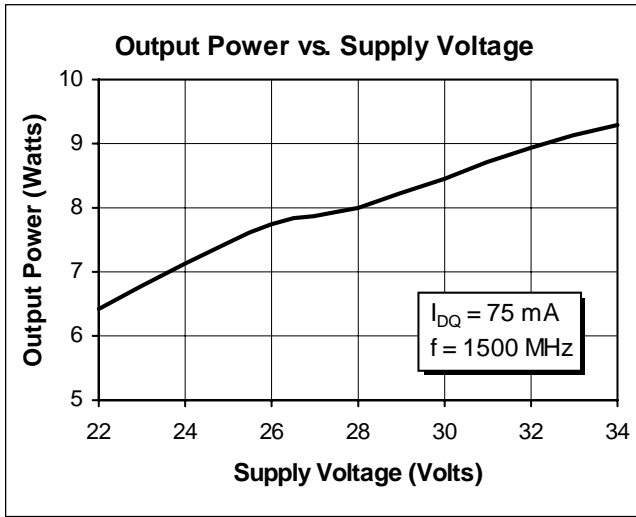

PTF 10111



Impedance Data

($V_{DD} = 28\text{ V}$, $I_{DQ} = 75\text{ mA}$, $P_{OUT} = 6\text{ W}$)

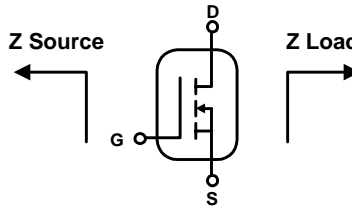

Frequency GHz	Z Source Ω		Z Load Ω	
	R	jX	R	jX
1.3	9.0	2.5	11.5	6.0
1.4	6.6	0.6	12.0	6.5
1.5	6.8	-1.0	11.5	7.3
1.5	6.9	-1.6	10.5	8.2
1.5	7.9	-0.6	9.0	5.4
1.6	8.3	0.2	9.1	4.9
1.7	8.2	0.5	10.0	4.0

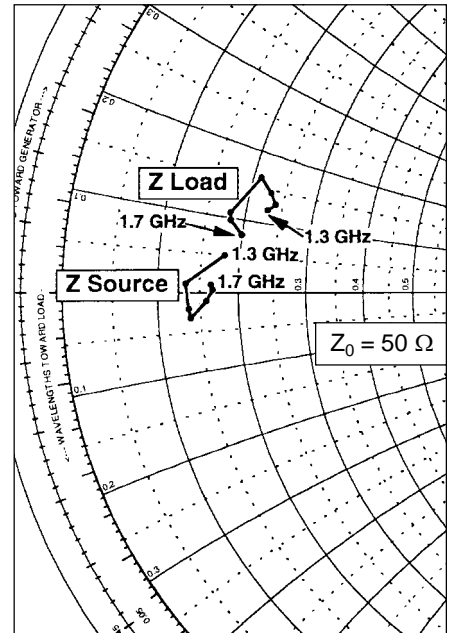

Typical Scattering Parameters

($V_{DS} = 28\text{ V}$, $I_D = 300\text{ mA}$)

f (MHz)	S11		S21		S12		S22	
	Mag	Ang	Mag	Ang	Mag	Ang	Mag	Ang
100	0.867	-65	21.8	131	0.010	42	0.801	-41
200	0.832	-77	19.2	123	0.011	34	0.765	-50
300	0.843	-106	14.4	97	0.013	18	0.740	-72
400	0.844	-123	11.0	81	0.014	4	0.744	-88
500	0.852	-133	8.71	69	0.013	-7	0.774	-98
600	0.862	-140	7.08	59	0.011	-15	0.815	-107
700	0.868	-146	5.79	50	0.009	-19	0.836	-116
800	0.874	-151	4.80	42	0.007	-19	0.851	-123
900	0.882	-155	4.05	35	0.006	-16	0.861	-129
1000	0.886	-158	3.48	29	0.004	-7	0.869	-133
1100	0.893	-161	3.04	24	0.003	20	0.885	-137
1200	0.899	-164	2.69	19	0.003	57	0.897	-141
1300	0.907	-167	2.43	14	0.005	74	0.912	-145
1400	0.905	-170	2.19	9	0.007	80	0.921	-148
1500	0.903	-173	2.00	4	0.008	83	0.928	-151
1600	0.898	-175	1.83	0	0.011	85	0.929	-154
1700	0.896	-177	1.71	-5	0.013	86	0.933	-157
1800	0.892	-179	1.60	-9	0.016	83	0.934	-159
1900	0.889	178	1.52	-13	0.020	78	0.937	-161
2000	0.885	176	1.45	-17	0.023	69	0.940	-163
2100	0.882	173	1.40	-21	0.023	59	0.944	-165
2200	0.880	171	1.37	-25	0.021	60	0.950	-168

Test Circuit

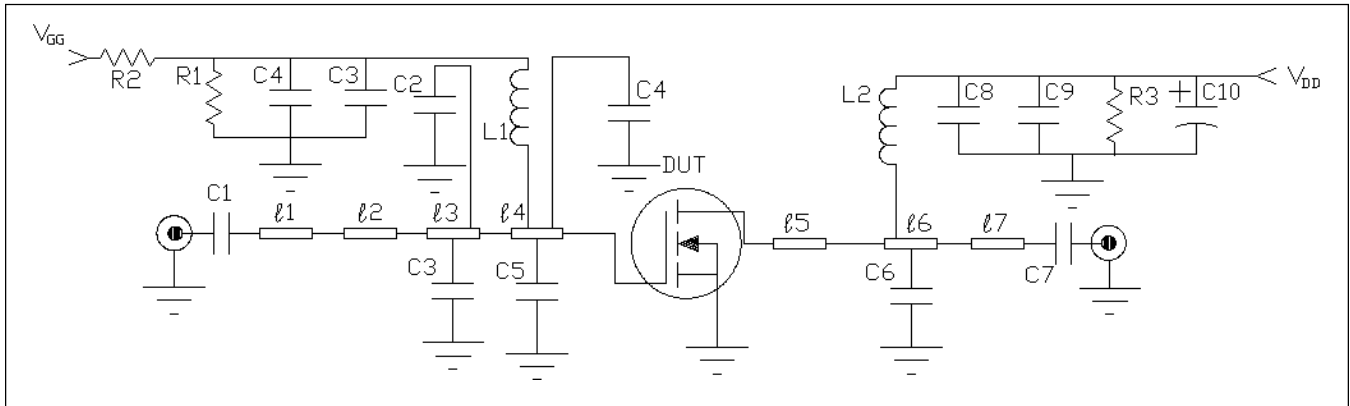

Test Circuit Block Diagram for $f = 1.5 \text{ GHz}$

DUT	PTF 10111
C1, C7-9	33 pF, Capacitor ATC 100 B
C2, C3	2.2 pF, Capacitor ATC 200 B
C10, C11	0.1 μF , 50 V, Capacitor
C4, C5	1.5 pF, Capacitor ATC 100 A
C6	2.0 pF, Capacitor ATC 100 A
C12	100 μF , 50 V, Electrolytic Capacitor
l1	0.21 λ 1.5 GHz Microstrip 50 Ω
l2	0.037 λ 1.5 GHz Microstrip 33.3 Ω

l3	0.045 λ 1.5 GHz	Microstrip 18.5 Ω
l4	0.13 λ 1.5 GHz	Microstrip 12.4 Ω
l5	0.07 λ 1.5 GHz	Microstrip 19.8 Ω
l6	0.20 λ 1.5 GHz	Microstrip 22 Ω
l7	0.18 λ 1.5 GHz	Microstrip 50 Ω
L1, L2	3 Turn, #22 AWG, 0.120" I.D.	
R1, R2, R3	10 K, 1/4 W Resistor	
Circuit Board	.028" Dielectric Thickness, $\epsilon_r = 4.0$, AlliedSignal, G200, 2 oz. copper	

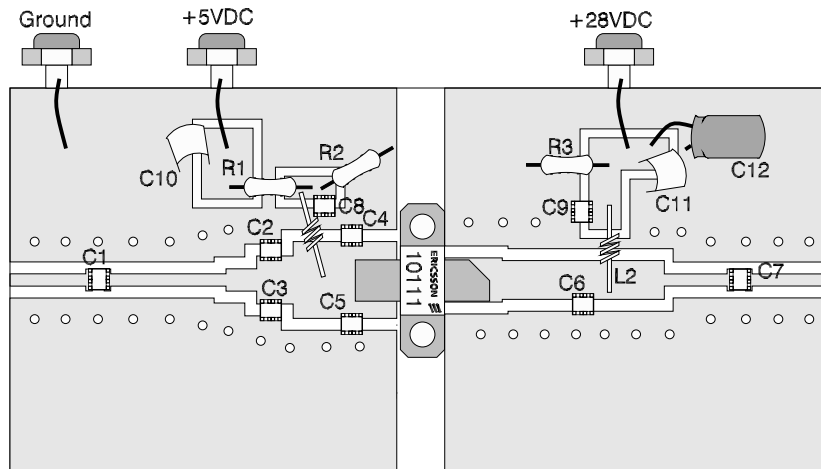

Placement Diagram (not to scale)

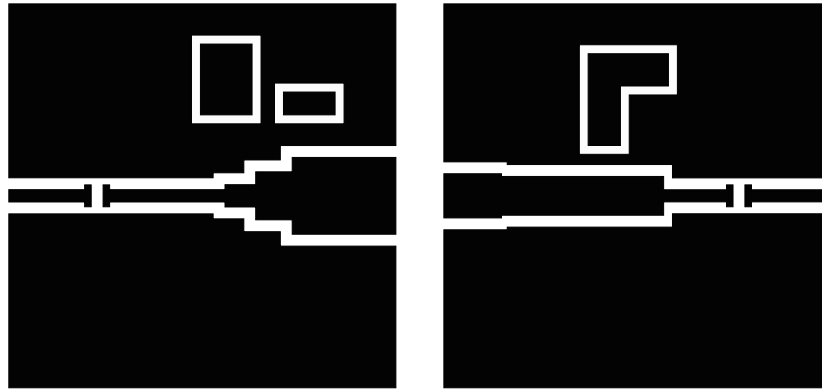

Artwork (1 inch )