

FEATURES

- **HIGH GAIN BANDWIDTH:** $f_T = 25$ GHz
- **LOW NOISE FIGURE:** $NF = 1.1$ dB at 2 GHz
- **HIGH MAXIMUM STABLE GAIN:** 20 dB at $f = 2$ GHz
- **NEW LOW PROFILE M16 PACKAGE:**
 - Flat Lead Style with a height of just 0.50mm

DESCRIPTION

The NE662M16 is fabricated using NEC's UHS0 25 GHz f_T wafer process. With a typical transition frequency of 25 GHz the NE662M16 is usable in applications from 100 MHz to over 10 GHz. The NE662M16 provides excellent low voltage/low current performance.

NEC's new low profile/flat lead style "M16" package is ideal for today's portable wireless applications. The NE662M16 is an ideal choice for LNA and oscillator requirements in all mobile communication systems.

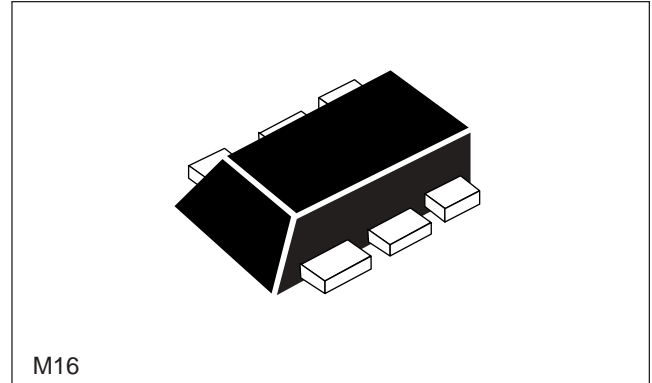

ELECTRICAL CHARACTERISTICS (T_A = 25°C)

PART NUMBER EIAJ ¹ REGISTERED NUMBER PACKAGE OUTLINE		NE662M16 2SC5704 M16				
SYMBOLS	PARAMETERS AND CONDITIONS	UNITS	MIN	TYP	MAX	
DC	ICBO	Collector Cutoff Current at V _{CB} = 5V, I _E = 0	nA		200	
	IEBO	Emitter Cutoff Current at V _{EB} = 1 V, I _C = 0	nA		200	
	h _{FE}	Forward Current Gain ² at V _{CE} = 2 V, I _C = 5 mA		50	70	100
RF	f _T	Gain Bandwidth at V _{CE} = 3 V, I _C = 30 mA, f = 2 GHz	GHz	20	25	
	MSG	Maximum Stable Gain ⁴ at V _{CE} = 2 V, I _C = 20 mA, f = 2 GHz	dB		20	
	S _{21E} ²	Insertion Power Gain at V _{CE} = 2 V, I _C = 20 mA, f = 2 GHz	dB	14	17	
	NF	Noise Figure at V _{CE} = 2 V, I _C = 5 mA, f = 2 GHz, Z _{IN} = Z _{OPT}	dB		1.1	1.5
	P _{1dB}	Output Power at 1 dB compression point at V _{CE} = 2 V, I _C = 20 mA, f = 2 GHz	dBm		11	
	IP ₃	Third Order Intercept Point at V _{CE} = 2 V, I _C = 20 mA, f = 2 GHz			22	
Cre	Feedback Capacitance ³ at V _{CB} = 2 V, I _C = 0, f = 1 MHz	pF		0.14	0.24	

Notes:

1. Electronic Industrial Association of Japan.
2. Pulsed measurement, pulse width ≤ 350 μ s, duty cycle ≤ 2 %.
3. Capacitance is measured by capacitance meter (automatic balance bridge method) when emitter pin is connected to the guard pin.

4. $MSG = \left| \frac{S_{21}}{S_{12}} \right|$

ABSOLUTE MAXIMUM RATINGS¹ (T_A = 25°C)

SYMBOLS	PARAMETERS	UNITS	RATINGS
V _{CB0}	Collector to Base Voltage	V	15
V _{CE0}	Collector to Emitter Voltage	V	3.3
V _{EB0}	Emitter to Base Voltage	V	1.5
I _C	Collector Current	mA	35
P _T	Total Power Dissipation	mW	115
T _J	Junction Temperature	°C	150
T _{STG}	Storage Temperature	°C	-65 to +150

Note:

1. Operation in excess of any one of these parameters may result in permanent damage.

ORDERING INFORMATION

PART NUMBER	QUANTITY	PACKAGING
NE662M16-T3	10 kpcs/reel	Pin 1 (Collector), Pin 6 (Emitter) face the perforation side on the tape.

OUTLINE DIMENSIONS (Units in mm)

PACKAGE OUTLINE M16

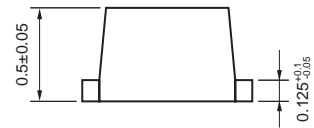
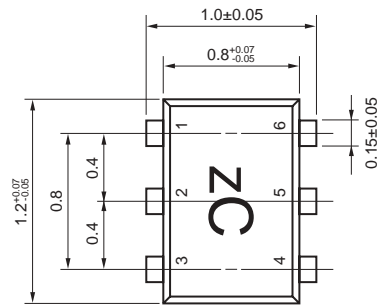

PIN CONNECTIONS

- | | |
|--------------|------------|
| 1. Collector | 4. Base |
| 2. Emitter | 5. Emitter |
| 3. Emitter | 6. Emitter |

TYPICAL PERFORMANCE CURVES (TA = 25°C)

TOTAL POWER DISSIPATION vs. AMBIENT TEMPERATURE

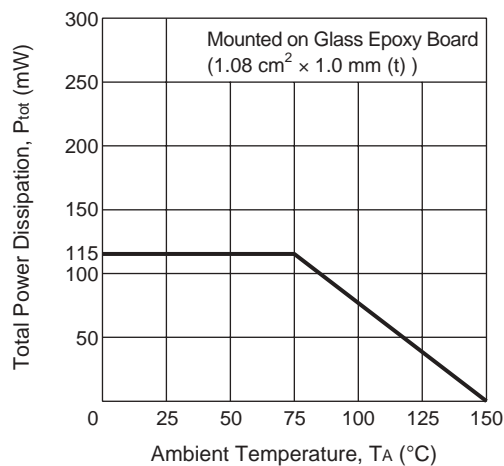

REVERSE TRANSFER CAPACITANCE vs. COLLECTOR TO BASE VOLTAGE

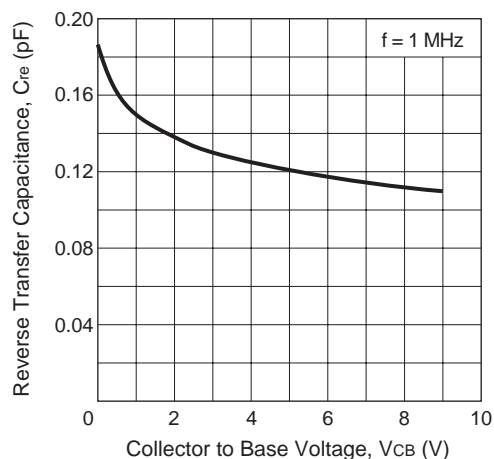

COLLECTOR CURRENT vs. BASE TO EMITTER VOLTAGE

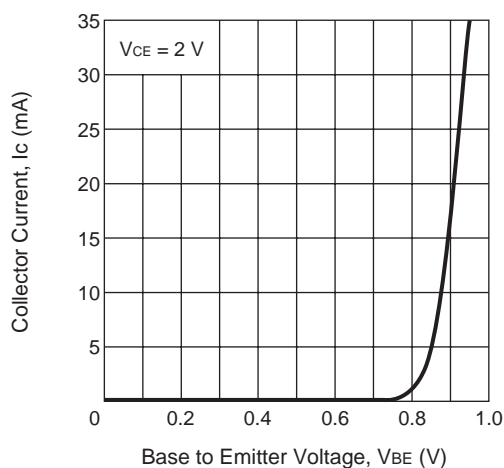

COLLECTOR CURRENT vs. COLLECTOR TO EMITTER VOLTAGE

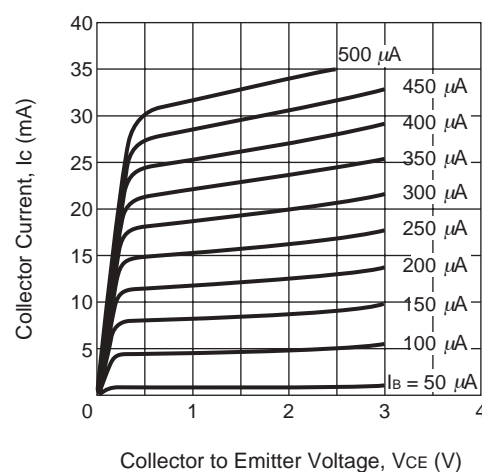

DC CURRENT GAIN vs. COLLECTOR CURRENT

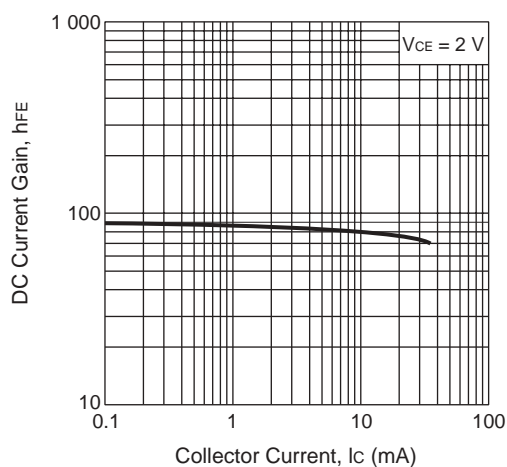

GAIN BANDWIDTH vs. COLLECTOR CURRENT

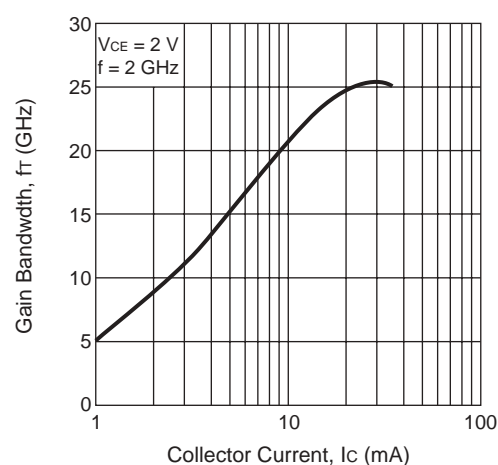

TYPICAL PERFORMANCE CURVES (TA = 25°C)

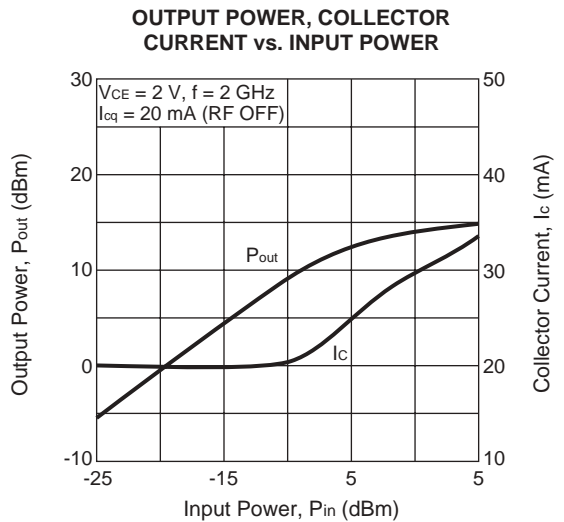
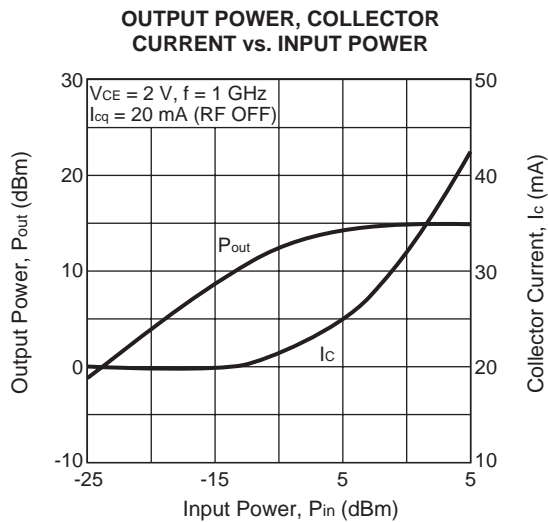
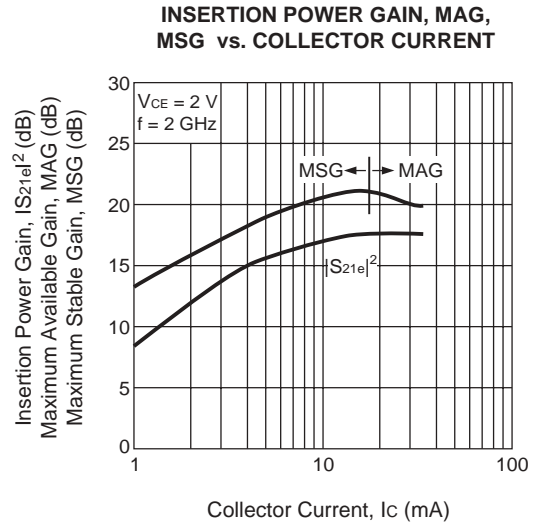
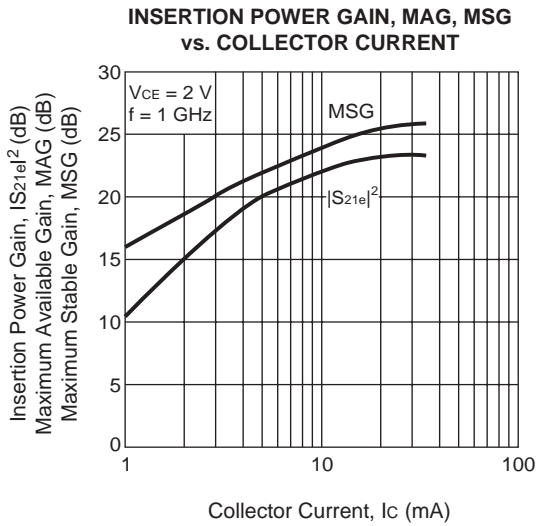
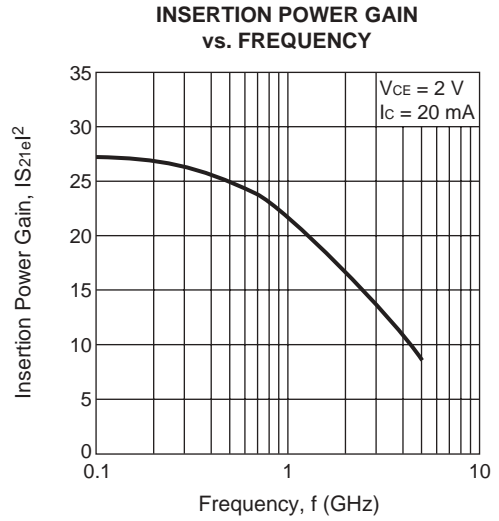
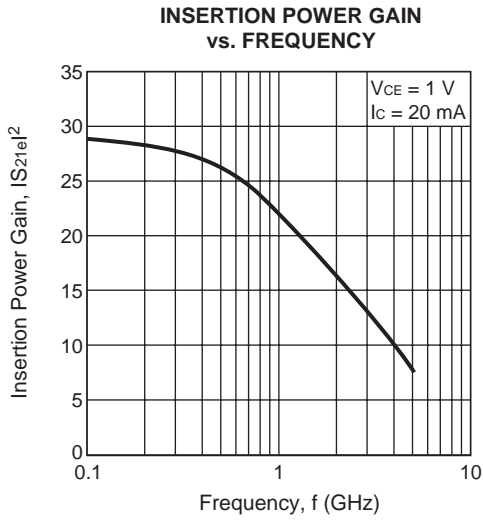

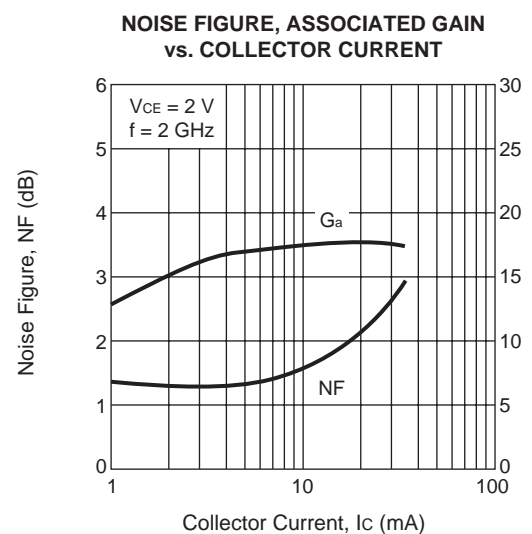
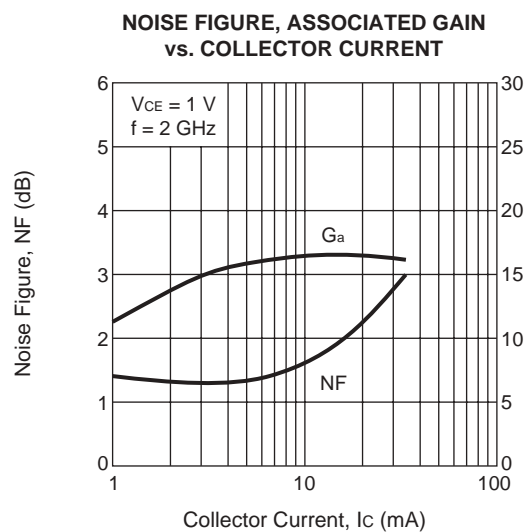
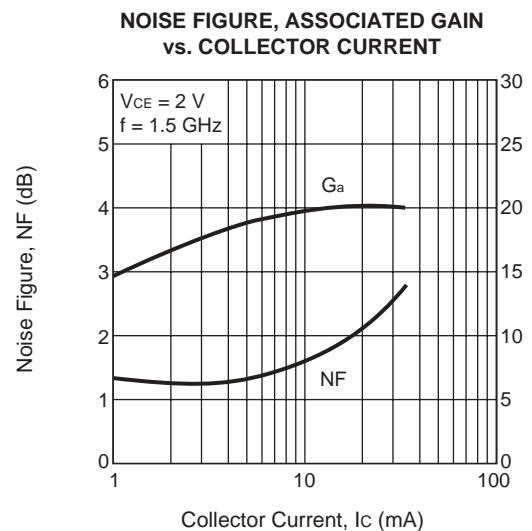
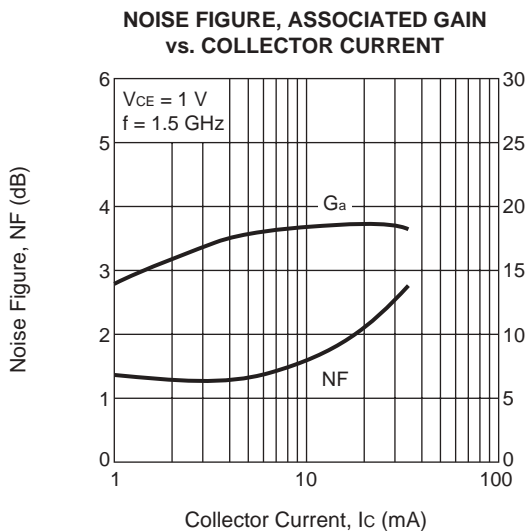
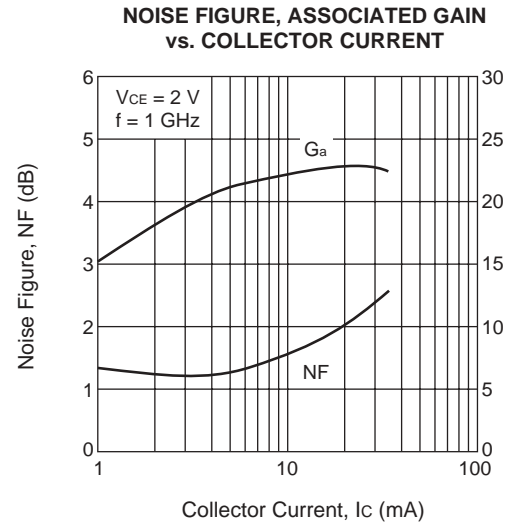
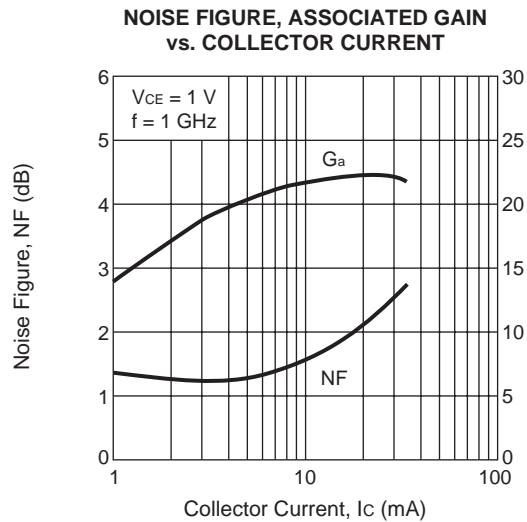
TYPICAL PERFORMANCE CURVES ($T_A = 25^\circ\text{C}$)

NE662M16

TYPICAL SCATTERING PARAMETERS (TA = 25°C)

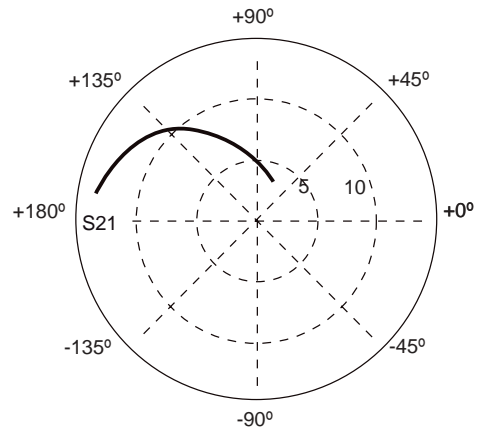
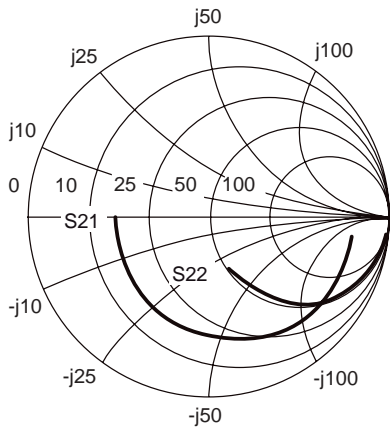

NE662M16

Vc = 2 V, Ic = 5 mA

FREQUENCY GHz	S11		S21		S12		S22		K	MAG ¹ (dB)
	MAG	ANG	MAG	ANG	MAG	ANG	MAG	ANG		
0.100	0.79	-8.34	13.52	171.32	0.01	84.69	0.98	-5.81	0.13	32.18
0.200	0.79	-20.52	13.20	165.06	0.02	78.92	0.96	-11.66	0.09	29.17
0.300	0.78	-30.77	12.77	158.29	0.02	73.38	0.93	-16.99	0.11	27.36
0.400	0.76	-39.87	12.28	152.12	0.03	68.92	0.90	-21.91	0.14	26.09
0.500	0.74	-48.66	11.75	146.29	0.04	64.34	0.87	-26.38	0.17	25.11
0.600	0.73	-56.79	11.15	140.96	0.04	60.23	0.83	-30.37	0.20	24.28
0.700	0.71	-64.12	10.59	136.12	0.05	56.71	0.79	-33.94	0.24	23.60
0.800	0.69	-71.30	10.02	131.99	0.05	53.36	0.76	-37.10	0.26	22.99
0.900	0.68	-77.50	9.48	128.20	0.05	50.48	0.72	-39.91	0.29	22.47
1.000	0.66	-83.36	8.98	124.77	0.06	47.89	0.69	-42.40	0.32	21.99
1.100	0.65	-88.67	8.55	121.61	0.06	45.67	0.66	-44.60	0.35	21.59
1.200	0.64	-93.70	8.15	118.55	0.06	43.73	0.64	-46.56	0.38	21.22
1.300	0.64	-98.23	7.79	115.75	0.06	42.02	0.61	-48.38	0.40	20.88
1.400	0.63	-102.48	7.45	113.15	0.07	40.50	0.59	-49.89	0.43	20.57
1.500	0.62	-106.53	7.14	110.70	0.07	39.06	0.57	-51.38	0.46	20.28
1.600	0.61	-110.24	6.82	108.22	0.07	37.77	0.55	-52.58	0.49	19.99
1.700	0.60	-113.97	6.57	105.79	0.07	36.69	0.53	-53.71	0.52	19.74
1.800	0.60	-117.60	6.36	103.81	0.07	35.72	0.51	-54.81	0.55	19.54
1.900	0.59	-120.80	6.11	102.01	0.07	34.87	0.50	-55.74	0.58	19.31
2.000	0.58	-124.09	5.86	99.85	0.07	34.09	0.48	-56.51	0.61	19.06
2.100	0.58	-127.67	5.69	97.73	0.07	33.33	0.47	-57.44	0.64	18.89
2.200	0.57	-130.76	5.51	95.62	0.07	32.59	0.46	-57.89	0.66	18.68
2.300	0.57	-133.98	5.37	94.20	0.08	32.26	0.44	-58.61	0.68	18.53
2.400	0.56	-136.85	5.16	92.25	0.08	31.81	0.43	-59.18	0.71	18.31
2.500	0.56	-139.86	5.03	90.06	0.08	31.21	0.42	-59.83	0.74	18.17
2.600	0.55	-142.72	4.88	88.26	0.08	30.84	0.41	-60.32	0.77	17.98
2.700	0.55	-145.66	4.75	86.62	0.08	30.55	0.40	-60.89	0.80	17.83
2.800	0.54	-148.25	4.58	84.94	0.08	30.18	0.39	-61.28	0.83	17.63
2.900	0.54	-151.04	4.46	82.99	0.08	30.00	0.38	-61.71	0.87	17.50
3.000	0.53	-153.76	4.35	81.42	0.08	29.61	0.37	-62.28	0.90	17.34
3.100	0.52	-156.67	4.21	79.85	0.08	29.45	0.36	-62.64	0.93	17.17
3.200	0.52	-159.41	4.09	78.16	0.08	29.21	0.36	-63.08	0.96	17.02
3.300	0.52	-162.03	4.00	76.53	0.08	28.97	0.35	-63.54	0.99	16.88
3.400	0.52	-164.80	3.89	75.17	0.08	28.78	0.34	-64.05	1.02	15.94
3.500	0.51	-167.55	3.78	73.64	0.08	28.67	0.33	-64.59	1.05	15.28
3.600	0.51	-170.15	3.68	71.91	0.08	28.50	0.32	-65.11	1.07	14.77
3.700	0.51	-172.65	3.61	70.42	0.08	28.28	0.32	-65.78	1.09	14.44
3.800	0.51	-174.91	3.51	69.29	0.08	28.15	0.31	-66.41	1.12	14.02
3.900	0.51	-177.27	3.40	67.93	0.09	28.08	0.30	-67.07	1.16	13.59
4.000	0.51	-179.59	3.31	66.28	0.09	27.96	0.29	-67.74	1.19	13.22

Note:

1. Gain Calculations:

$$MAG = \frac{|S_{21}|}{|S_{12}|} (K \pm \sqrt{K^2 - 1}). \text{ When } K \leq 1, \text{ MAG is undefined and MSG values are used. } MSG = \frac{|S_{21}|}{|S_{12}|}, K = \frac{1 + |\Delta|^2 - |S_{11}|^2 - |S_{22}|^2}{2 |S_{12} S_{21}|}, \Delta = S_{11} S_{22} - S_{21} S_{12}$$

MAG = Maximum Available Gain

MSG = Maximum Stable Gain

TYPICAL SCATTERING PARAMETERS (T_A = 25°C)

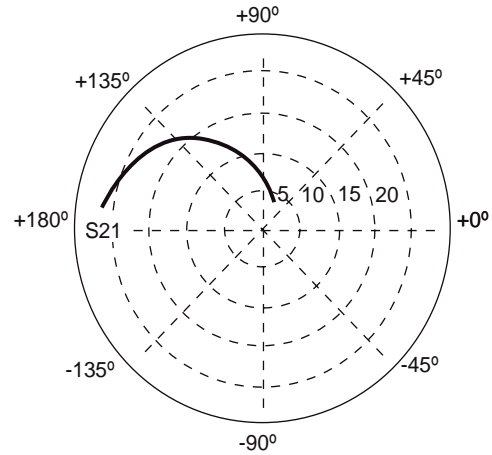
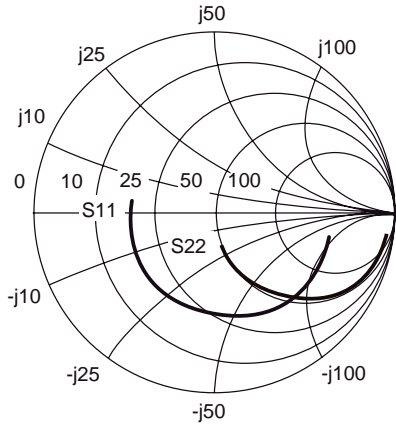

NE662M16

V_c = 2 V, I_c = 10 mA

FREQUENCY GHz	S ₁₁		S ₂₁		S ₁₂		S ₂₂		K	MAG ¹ (dB)
	MAG	ANG	MAG	ANG	MAG	ANG	MAG	ANG		
0.100	0.66	-12.81	21.08	170.08	0.01	81.45	0.96	-7.79	0.19	34.48
0.200	0.66	-28.48	20.34	161.46	0.01	76.90	0.94	-15.60	0.13	31.43
0.300	0.65	-41.93	19.32	153.18	0.02	70.56	0.90	-22.67	0.16	29.60
0.400	0.63	-53.87	18.18	145.93	0.03	65.20	0.85	-28.92	0.20	28.32
0.500	0.61	-64.70	16.97	139.38	0.03	60.63	0.80	-34.46	0.24	27.29
0.600	0.60	-74.41	15.75	133.63	0.04	56.67	0.75	-39.19	0.28	26.47
0.700	0.58	-82.86	14.65	128.64	0.04	53.54	0.70	-43.27	0.33	25.76
0.800	0.57	-90.61	13.62	124.38	0.04	50.71	0.66	-46.77	0.37	25.14
0.900	0.56	-97.18	12.70	120.59	0.04	48.39	0.62	-49.77	0.41	24.59
1.000	0.55	-103.22	11.88	117.23	0.05	46.60	0.58	-52.36	0.45	24.11
1.100	0.55	-108.53	11.17	114.18	0.05	45.17	0.55	-54.59	0.49	23.68
1.200	0.54	-113.37	10.51	111.31	0.05	43.92	0.52	-56.54	0.52	23.28
1.300	0.54	-117.69	9.95	108.65	0.05	42.92	0.50	-58.27	0.56	22.91
1.400	0.53	-121.63	9.43	106.24	0.05	42.14	0.47	-59.73	0.59	22.57
1.500	0.53	-125.35	8.96	103.96	0.05	41.39	0.45	-61.06	0.63	22.24
1.600	0.52	-128.85	8.50	101.70	0.05	40.83	0.43	-62.21	0.66	21.92
1.700	0.52	-132.25	8.13	99.47	0.06	40.51	0.42	-63.19	0.70	21.65
1.800	0.52	-135.50	7.82	97.63	0.06	40.23	0.40	-64.16	0.73	21.39
1.900	0.51	-138.46	7.48	96.05	0.06	39.88	0.38	-64.99	0.76	21.12
2.000	0.51	-141.58	7.14	94.06	0.06	39.77	0.37	-65.63	0.80	20.83
2.100	0.51	-144.72	6.89	92.12	0.06	39.58	0.36	-66.43	0.82	20.62
2.200	0.50	-147.54	6.66	90.21	0.06	39.38	0.35	-66.83	0.84	20.38
2.300	0.50	-150.41	6.44	88.94	0.06	39.49	0.34	-67.39	0.87	20.17
2.400	0.50	-153.04	6.17	87.15	0.06	39.53	0.33	-67.86	0.90	19.91
2.500	0.50	-155.65	5.98	85.19	0.06	39.40	0.32	-68.39	0.93	19.72
2.600	0.49	-158.30	5.80	83.57	0.07	39.29	0.31	-68.81	0.95	19.50
2.700	0.49	-160.91	5.61	82.16	0.07	39.33	0.30	-69.31	0.98	19.29
2.800	0.49	-163.29	5.40	80.62	0.07	39.31	0.29	-69.61	1.01	18.53
2.900	0.48	-165.82	5.24	78.93	0.07	39.52	0.28	-70.04	1.04	17.69
3.000	0.48	-168.40	5.09	77.50	0.07	39.41	0.27	-70.48	1.06	17.14
3.100	0.47	-171.02	4.93	76.12	0.07	39.56	0.27	-70.87	1.09	16.67
3.200	0.47	-173.52	4.78	74.60	0.07	39.47	0.26	-71.30	1.11	16.22
3.300	0.47	-175.90	4.66	73.12	0.07	39.46	0.25	-71.76	1.13	15.88
3.400	0.47	-178.39	4.53	71.93	0.07	39.49	0.24	-72.30	1.15	15.52
3.500	0.47	-179.16	4.39	70.55	0.07	39.50	0.24	-72.89	1.17	15.17
3.600	0.47	-176.86	4.27	69.00	0.08	39.45	0.23	-73.50	1.19	14.85
3.700	0.47	-174.73	4.18	67.66	0.08	39.36	0.22	-74.30	1.21	14.60
3.800	0.47	-172.77	4.06	66.70	0.08	39.24	0.22	-75.12	1.23	14.28
3.900	0.47	-170.80	3.93	65.49	0.08	39.22	0.21	-75.94	1.25	13.93
4.000	0.47	-168.82	3.83	63.99	0.08	39.15	0.20	-76.91	1.27	13.64

Note:

1. Gain Calculations:

$$MAG = \frac{|S_{21}|}{|S_{12}|} (K \pm \sqrt{K^2 - 1})$$

When $K \leq 1$, MAG is undefined and MSG values are used. $MSG = \frac{|S_{21}|}{|S_{12}|}$, $K = \frac{1 + |\Delta|^2 - |S_{11}|^2 - |S_{22}|^2}{2 |S_{12} S_{21}|}$, $\Delta = S_{11} S_{22} - S_{21} S_{12}$

MAG = Maximum Available Gain

MSG = Maximum Stable Gain

TYPICAL SCATTERING PARAMETERS (T_A = 25°C)

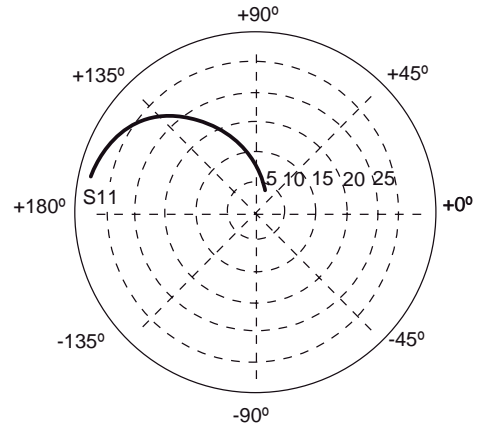
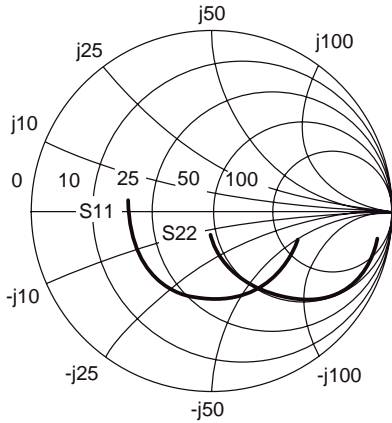

NE662M16

V_C = 2 V, I_C = 20 mA

FREQUENCY GHz	S ₁₁		S ₂₁		S ₁₂		S ₂₂		K	MAG ¹ (dB)
	MAG	ANG	MAG	ANG	MAG	ANG	MAG	ANG		
0.100	0.51	-19.24	28.64	168.38	0.01	79.10	0.94	-9.68	0.26	36.13
0.200	0.51	-39.58	27.18	157.71	0.01	74.03	0.90	-19.55	0.20	33.13
0.300	0.51	-56.67	25.27	148.17	0.02	67.79	0.85	-28.23	0.23	31.27
0.400	0.51	-71.47	23.19	140.08	0.02	62.44	0.79	-35.68	0.28	29.98
0.500	0.50	-83.85	21.13	133.18	0.03	58.17	0.72	-41.91	0.33	28.93
0.600	0.50	-94.44	19.22	127.33	0.03	54.93	0.66	-47.08	0.39	28.06
0.700	0.49	-103.20	17.57	122.40	0.03	52.50	0.61	-51.40	0.44	27.33
0.800	0.49	-110.77	16.11	118.27	0.03	50.56	0.56	-55.03	0.49	26.69
0.900	0.49	-117.07	14.85	114.65	0.04	49.13	0.52	-58.07	0.54	26.11
1.000	0.49	-122.58	13.76	111.47	0.04	48.10	0.49	-60.66	0.59	25.60
1.100	0.48	-127.34	12.83	108.63	0.04	47.35	0.46	-62.85	0.64	25.12
1.200	0.48	-131.56	11.98	105.97	0.04	46.96	0.43	-64.73	0.68	24.67
1.300	0.48	-135.30	11.27	103.49	0.04	46.65	0.41	-66.43	0.72	24.27
1.400	0.48	-138.62	10.62	101.28	0.04	46.44	0.39	-67.82	0.75	23.88
1.500	0.48	-141.83	10.04	99.19	0.04	46.48	0.37	-69.05	0.79	23.50
1.600	0.48	-144.87	9.49	97.12	0.05	46.28	0.35	-70.13	0.83	23.14
1.700	0.48	-147.80	9.04	95.06	0.05	46.44	0.33	-71.09	0.86	22.81
1.800	0.47	-150.55	8.66	93.37	0.05	46.55	0.32	-71.97	0.89	22.51
1.900	0.47	-153.08	8.25	91.95	0.05	46.81	0.31	-72.73	0.92	22.19
2.000	0.47	-155.81	7.86	90.10	0.05	46.88	0.29	-73.33	0.95	21.87
2.100	0.47	-158.52	7.56	88.29	0.05	46.96	0.28	-74.04	0.97	21.60
2.200	0.47	-161.02	7.29	86.54	0.05	47.15	0.27	-74.48	0.99	21.33
2.300	0.47	-163.41	7.03	85.38	0.05	47.44	0.26	-74.96	1.01	20.46
2.400	0.47	-165.69	6.72	83.75	0.06	47.56	0.26	-75.41	1.04	19.60
2.500	0.47	-167.97	6.50	81.93	0.06	47.55	0.25	-75.93	1.06	19.05
2.600	0.46	-170.37	6.29	80.42	0.06	47.65	0.24	-76.35	1.07	18.61
2.700	0.46	-172.58	6.07	79.19	0.06	47.79	0.23	-76.85	1.09	18.15
2.800	0.46	-174.73	5.84	77.76	0.06	47.81	0.22	-77.18	1.12	17.64
2.900	0.46	-177.01	5.65	76.22	0.06	47.96	0.21	-77.67	1.14	17.23
3.000	0.45	-179.36	5.49	74.88	0.06	47.89	0.21	-78.08	1.16	16.88
3.100	0.45	178.28	5.31	73.63	0.07	48.00	0.20	-78.62	1.17	16.51
3.200	0.45	176.08	5.14	72.22	0.07	47.97	0.19	-79.11	1.19	16.16
3.300	0.45	173.87	5.00	70.83	0.07	47.81	0.19	-79.69	1.20	15.87
3.400	0.45	171.68	4.86	69.75	0.07	47.81	0.18	-80.42	1.22	15.56
3.500	0.45	169.53	4.71	68.47	0.07	47.78	0.18	-81.20	1.23	15.26
3.600	0.46	167.47	4.58	67.03	0.07	47.68	0.17	-82.06	1.24	14.97
3.700	0.46	165.67	4.47	65.80	0.07	47.46	0.16	-83.19	1.25	14.74
3.800	0.46	163.96	4.34	64.93	0.08	47.30	0.16	-84.30	1.27	14.44
3.900	0.46	162.28	4.21	63.80	0.08	47.24	0.15	-85.66	1.29	14.12
4.000	0.46	160.56	4.09	62.37	0.08	46.96	0.15	-87.01	1.30	13.86

Note:

1. Gain Calculations:

$$MAG = \frac{|S_{21}|}{|S_{12}|} \left(K \pm \sqrt{K^2 - 1} \right). \text{ When } K \leq 1, \text{ MAG is undefined and MSG values are used. } MSG = \frac{|S_{21}|}{|S_{12}|}, K = \frac{1 + |\Delta|^2 - |S_{11}|^2 - |S_{22}|^2}{2 |S_{12} S_{21}|}, \Delta = S_{11} S_{22} - S_{21} S_{12}$$

MAG = Maximum Available Gain

MSG = Maximum Stable Gain

NE662M16 NONLINEAR MODEL

SCHEMATIC

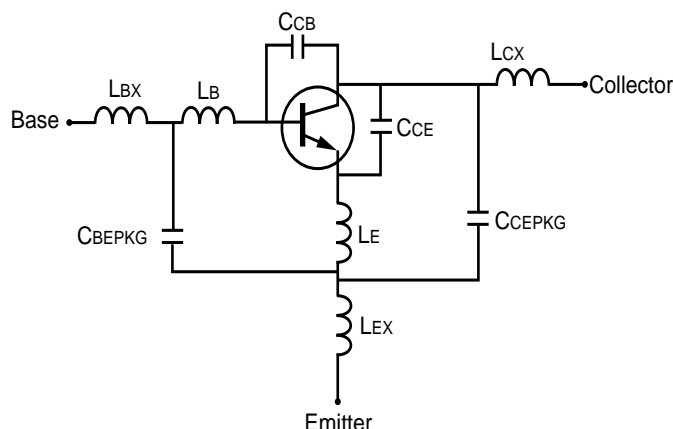
BJT NONLINEAR MODEL PARAMETERS ⁽¹⁾

Parameters	Q1	Parameters	Q1
IS	1.6e-16	MJC	0.3
BF	105	XCJC	0.1
NF	1.02	CJS	0
VAF	23	VJS	0.75
IKF	0.38	MJS	0
ISE	1e-6	FC	0.6
NE	30	TF	2e-12
BR	12	XTF	0.2
NR	1.02	VTF	0.2
VAR	2.5	ITF	0.03
IKR	0.1	PTF	0
ISC	3e-15	TR	1e-11
NC	1.28	EG	1.11
RE	1.1	XTB	0
RB	6	XTI	3
RBM	3.5	KF	0
IRB	1.3e-3	AF	1
RC	8.75		
CJE	0.4e-12		
VJE	0.6		
MJE	0.5		
CJC	0.1e-12		
VJC	0.75		

(1) Gummel-Poon Model

ADDITIONAL PARAMETERS

Parameters	NE662M16
CCB	0.07e-12
CCE	0.09e-12
LB	0.4e-9
LE	0.14e-9
CCEPKG	0.12e-12
CBEPK	0.1e-12
LBX	0.1e-9
LCX	0.6e-9
LEX	0.04e-9

MODEL RANGE

Frequency: 0.1 to 4 GHz
 Bias: $V_{CE} = 0.5 \text{ V to } 3 \text{ V}$, $I_c = 1 \text{ mA to } 30 \text{ mA}$
 Date: 01/15/2002

Life Support Applications

These NEC products are not intended for use in life support devices, appliances, or systems where the malfunction of these products can reasonably be expected to result in personal injury. The customers of CEL using or selling these products for use in such applications do so at their own risk and agree to fully indemnify CEL for all damages resulting from such improper use or sale.

EXCLUSIVE NORTH AMERICAN AGENT FOR NEC RF, MICROWAVE & OPTOELECTRONIC SEMICONDUCTORS

CEL CALIFORNIA EASTERN LABORATORIES • Headquarters • 4590 Patrick Henry Drive • Santa Clara, CA 95054-1817 • (408) 988-3500 • Telex 34-6393 • FAX (408) 988-0279
 DATA SUBJECT TO CHANGE WITHOUT NOTICE Internet: <http://WWW.CEL.COM>

01/22/2002