

RF AMPLIFIER FOR UHF TUNER
N-CHANNEL Si DUAL GATE MOS FIELD-EFFECT TRANSISTOR
4 PINS MINI MOLD

FEATURES

- Low V_{DD} Use : ($V_{DS} = 3.5$ V)
- Driving Battery
- Low Noise Figure : $NF = 1.8$ dB TYP. ($f = 900$ MHz)
- High Power Gain : $G_{PS} = 18.0$ dB TYP. ($f = 900$ MHz)
- Suitable for use as RF amplifier in UHF TV tuner.
- Automatically Mounting : Embossed Type Taping
- Package : 4 Pins Mini Mold

ABSOLUTE MAXIMUM RATINGS ($T_A = 25$ °C)

Drain to Source Voltage	V_{DSX}	18	V
Gate1 to Source Voltage	V_{G1S}	$\pm 8^{*1}$	V
Gate2 to Source Voltage	V_{G2S}	$\pm 8^{*1}$	V
Gate1 to Drain Voltage	V_{G1D}	18	V
Gate2 to Drain Voltage	V_{G2D}	18	V
Drain Current	I_D	25	mA
Total Power Dissipation	P_D	200^{*2}	mW
Channel Temperature	T_{ch}	125	°C
Storage Temperature	T_{stg}	-55 to +125	°C

*1: $R_L \geq 10$ k Ω

*2: Free air

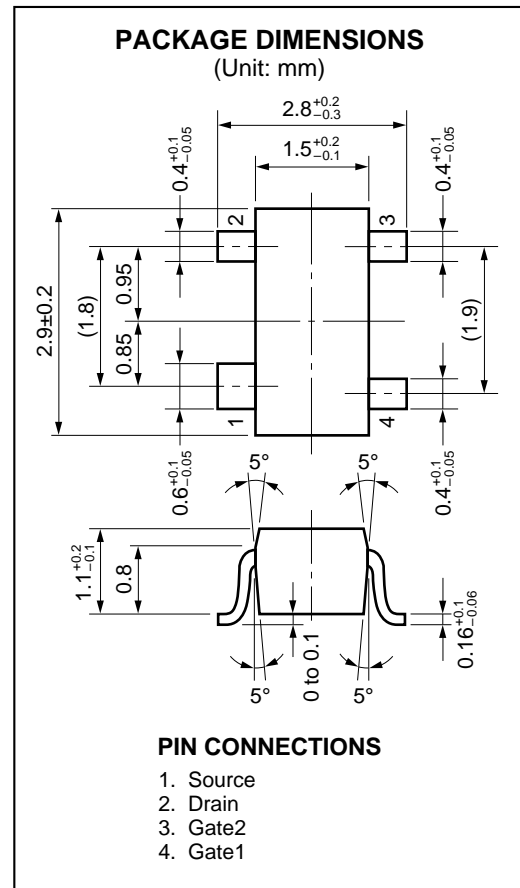
**PRECAUTION:**

Avoid high static voltages or electric fields so that this device would not suffer from any damage due to those voltage fields.

ELECTRICAL CHARACTERISTICS (T_A = 25 °C)

CHARACTERISTIC	SYMBOL	MIN.	TYP.	MAX.	UNIT	TEST CONDITIONS
Drain to Source Breakdown Voltage	BV _{DSX}	18			V	V _{G1S} = V _{G2S} = -2 V, I _D = 10 μA
Drain Current	I _{DSX}	0.5		7.0	mA	V _{DS} = 3.5 V, V _{G2S} = 3 V, V _{G1S} = 0.75 V
Gate1 to Source Cutoff Voltage	V _{G1S(off)}	-1.0	0	+1.0	V	V _{DS} = 3.5 V, V _{G2S} = 3 V, I _D = 10 μA
Gate2 to Source Cutoff Voltage	V _{G2S(off)}	0	0.5	1.0	V	V _{DS} = 3.5 V, V _{G1S} = 3 V, I _D = 10 μA
Gate1 Reverse Current	I _{G1SS}			±20	nA	V _{DS} = 0, V _{G2S} = 0, V _{G1S} = ±6 V
Gate2 Reverse Current	I _{G2SS}			±20	nA	V _{DS} = 0, V _{G1S} = 0, V _{G2S} = ±6 V
Forward Transfer Admittance	y _{fs}	14	19	24	mS	V _{DS} = 3.5 V, V _{G2S} = 3 V, I _D = 7 mA f = 1 kHz
Input Capacitance	C _{iss}	1.5	2.0	2.5	pF	V _{DS} = 3.5 V, V _{G2S} = 3 V, I _D = 7 mA f = 1 MHz
Output Capacitance	C _{oss}	0.5	1.0	1.5	pF	
Reverse Transfer Capacitance	C _{rss}		0.01	0.03	pF	
Power Gain	G _{ps}	15	18	21	dB	V _{DS} = 3.5 V, V _{G2S} = 3 V, I _D = 7 mA
Noise Figure	NF		1.8	3.0	dB	f = 900 MHz

I_{DSX} Classification

Rank	U1G/UAG*
Marking	U1G
I _{DSX} (mA)	0.5 to 7.0

* Old specification / New specification

TYPICAL CHARACTERISTICS (TA = 25 °C)

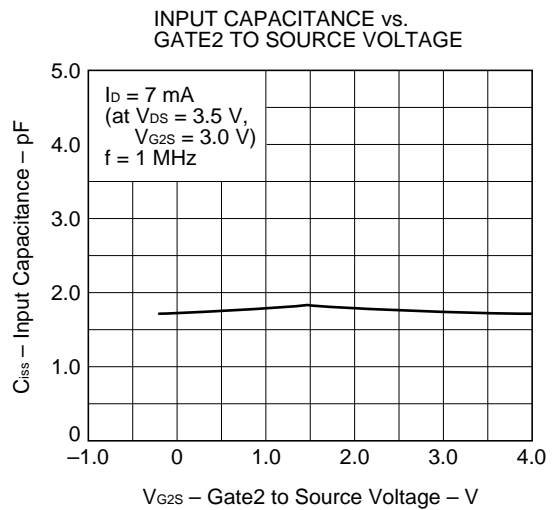
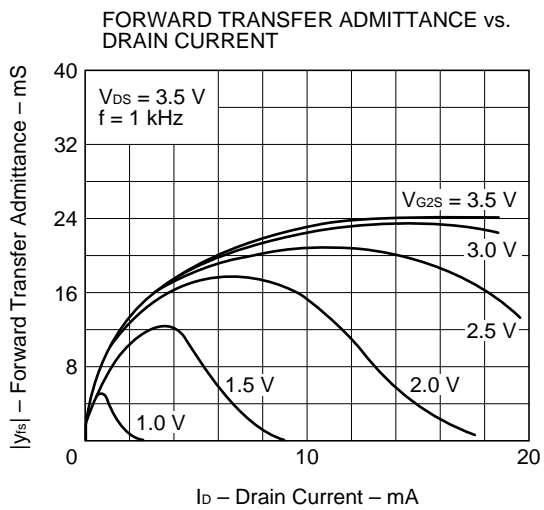
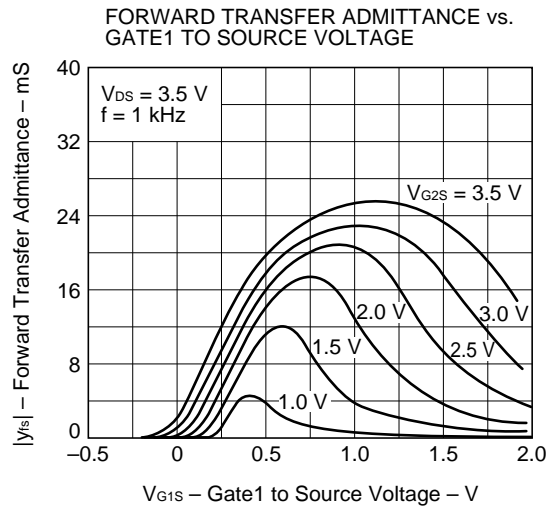
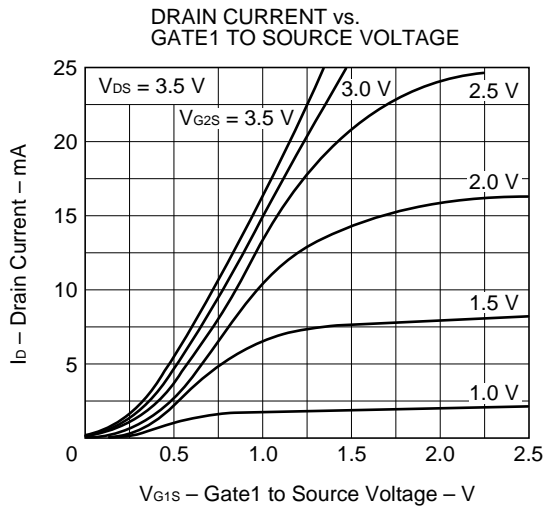
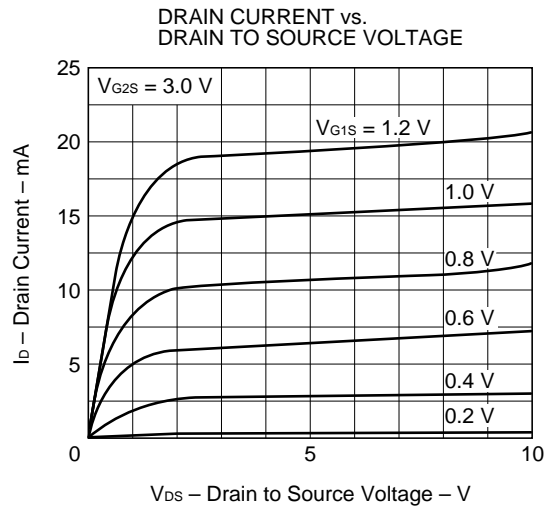
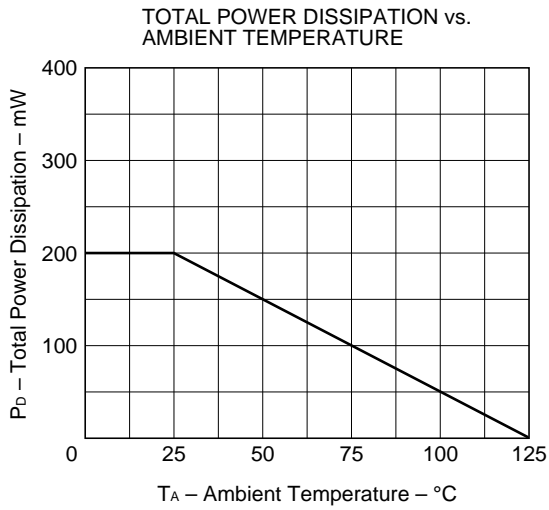

OUTPUT CAPACITANCE vs. GATE2 TO SOURCE VOLTAGE

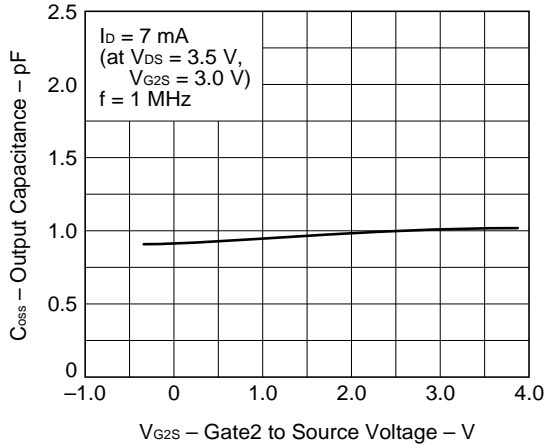

POWER GAIN AND NOISE FIGURE vs. GATE2 TO SOURCE VOLTAGE

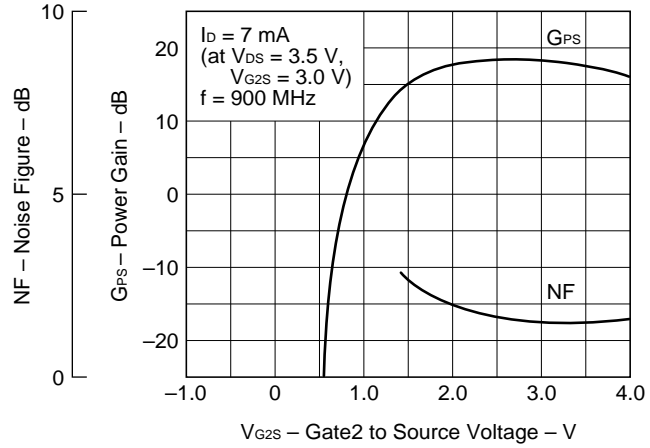

G_{PS} AND NF TEST CIRCUIT AT f = 900 MHz

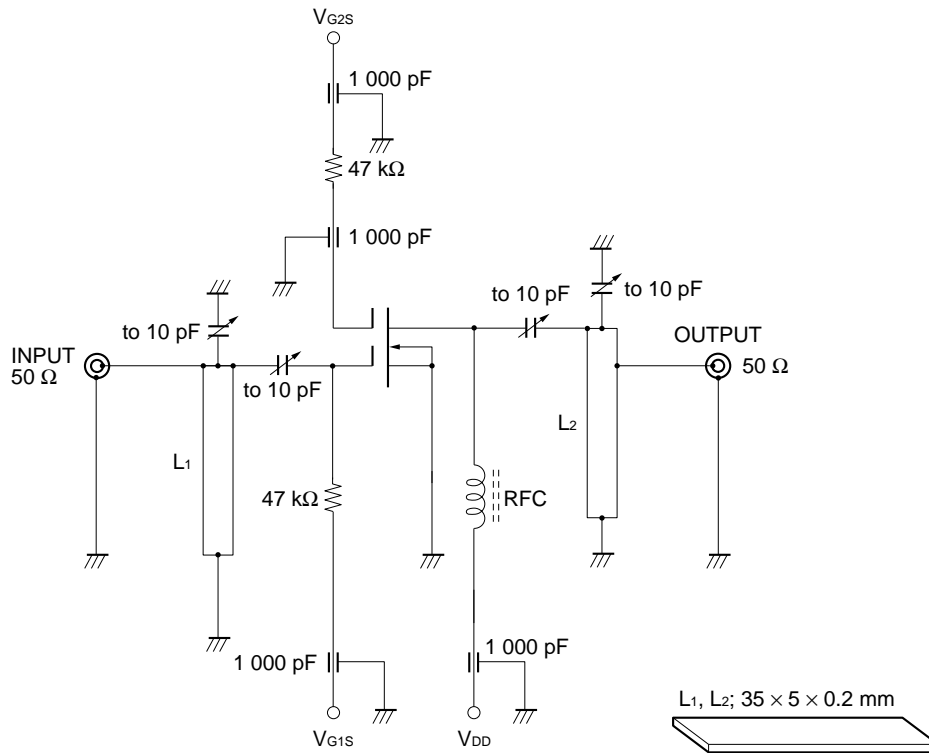

[MEMO]

No part of this document may be copied or reproduced in any form or by any means without the prior written consent of NEC Corporation. NEC Corporation assumes no responsibility for any errors which may appear in this document.

NEC Corporation does not assume any liability for infringement of patents, copyrights or other intellectual property rights of third parties by or arising from use of a device described herein or any other liability arising from use of such device. No license, either express, implied or otherwise, is granted under any patents, copyrights or other intellectual property rights of NEC Corporation or others.

While NEC Corporation has been making continuous effort to enhance the reliability of its semiconductor devices, the possibility of defects cannot be eliminated entirely. To minimize risks of damage or injury to persons or property arising from a defect in an NEC semiconductor device, customer must incorporate sufficient safety measures in its design, such as redundancy, fire-containment, and anti-failure features.

NEC devices are classified into the following three quality grades:

"Standard", "Special", and "Specific". The Specific quality grade applies only to devices developed based on a customer designated "quality assurance program" for a specific application. The recommended applications of a device depend on its quality grade, as indicated below. Customers must check the quality grade of each device before using it in a particular application.

Standard: Computers, office equipment, communications equipment, test and measurement equipment, audio and visual equipment, home electronic appliances, machine tools, personal electronic equipment and industrial robots

Special: Transportation equipment (automobiles, trains, ships, etc.), traffic control systems, anti-disaster systems, anti-crime systems, safety equipment and medical equipment (not specifically designed for life support)

Specific: Aircrafts, aerospace equipment, submersible repeaters, nuclear reactor control systems, life support systems or medical equipment for life support, etc.

The quality grade of NEC devices in "Standard" unless otherwise specified in NEC's Data Sheets or Data Books. If customers intend to use NEC devices for applications other than those specified for Standard quality grade, they should contact NEC Sales Representative in advance.

Anti-radioactive design is not implemented in this product.