

GaAs N-channel Dual Gate MES FET

Description

The 3SK166A is an N-channel dual gate GaAs MES FET for UHF band low-noise amplification. The circuit matching is easier to be made for all UHF band, resulting in the excellent performance, due to the optimal design of input impedance.

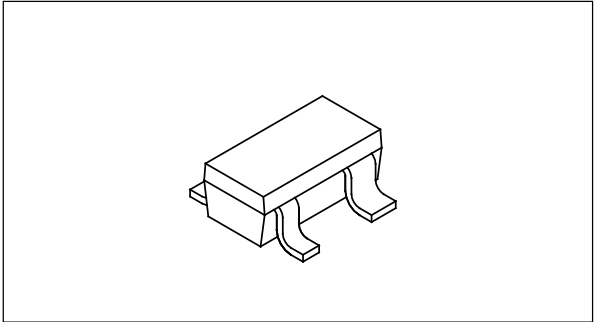

Features

- Low voltage operation
- Low noise: NF = 1.2dB (typ.) at 800MHz
- High gain: Ga = 20dB (typ) at 800MHz
- High stability

Application

UHF band amplifier, oscillator

Structure

GaAs N-channel dual-gate metal semiconductor field-effect transistor

Absolute Maximum Ratings (Ta = 25°C)

• Drain to source voltage	V_{DSX}	8	V
• Gate 1 to source voltage	V_{G1S}	-6	V
• Gate 2 to source voltage	V_{G2S}	-6	V
• Drain current	I_D	80	mA
• Allowable power dissipation	P_D	150	mW
• Channel temperature	T_{ch}	150	°C
• Storage temperature	T_{stg}	-55 to +150	°C

Sony reserves the right to change products and specifications without prior notice. This information does not convey any license by any implication or otherwise under any patents or other right. Application circuits shown, if any, are typical examples illustrating the operation of the devices. Sony cannot assume responsibility for any problems arising out of the use of these circuits.

Electrical Characteristics

(Ta = 25°C)

Item	Symbol	Condition	Min.	Typ.	Max.	Unit
Drain cut-off current	I _{DSX}	V _{DS} = 8V V _{G1S} = -4V V _{G2S} = 0V			100	μA
Gate 1 to source current	I _{G1SS}	V _{G1S} = -5V V _{G2S} = 0V V _{DS} = 0V			-20	μA
Gate 2 to source current	I _{G2SS}	V _{G2S} = -5V V _{G1S} = 0V V _{DS} = 0V			-20	μA
Drain saturation current	I _{DSS}	V _{DS} = 5V V _{G1S} = 0V V _{G2S} = 0V	20		80	mA
Gate 1 to source cut-off voltage	V _{G1S} (OFF)	V _{DS} = 5V I _D = 100μA V _{G2S} = 0V	-1		-4	V
Gate 2 to source cut-off voltage	V _{G2S} (OFF)	V _{DS} = 5V I _D = 100μA V _{G1S} = 0V	-1		-4	V
Forward transfer admittance	g _m	V _{DS} = 5V I _D = 10mA V _{G2S} = 1.5V f = 1kHz	25	40		ms
Input capacitance	C _{iSS}	V _{DS} = 5V I _D = 10mA V _{G2S} = 1.5V f = 1MHz		1.3	2.0	pF
Feedback capacitance	C _{rSS}			25	40	fF
Noise figure	NF	V _{DS} = 5V I _D = 10mA V _{G2S} = 1.5V f = 800MHz		1.2	2.5	dB
Associated gain	G _a		18	20		dB

* I_{DSS} classification

Product name classification	I _{DSS} RANK
3SK166A-0	20 to 80mA
3SK166A-2	45 to 80mA

Typical Characteristics (Ta = 25°C)

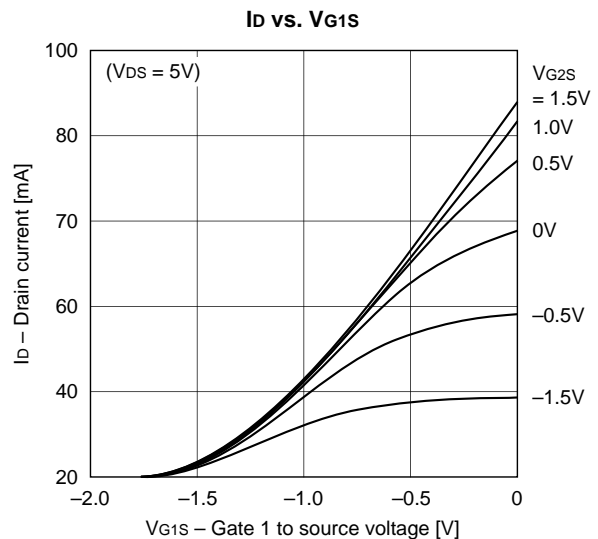
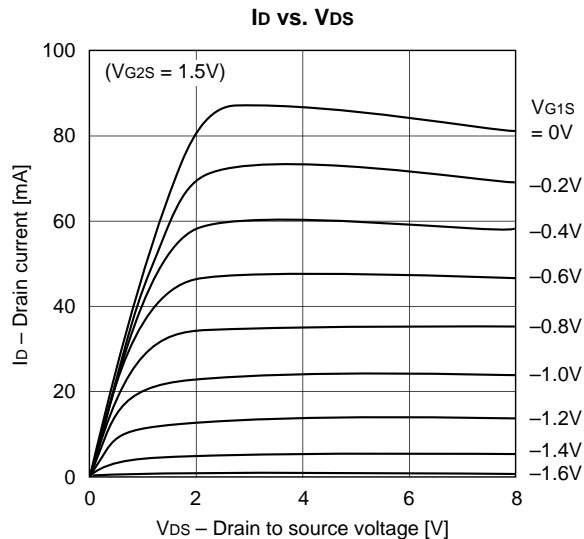

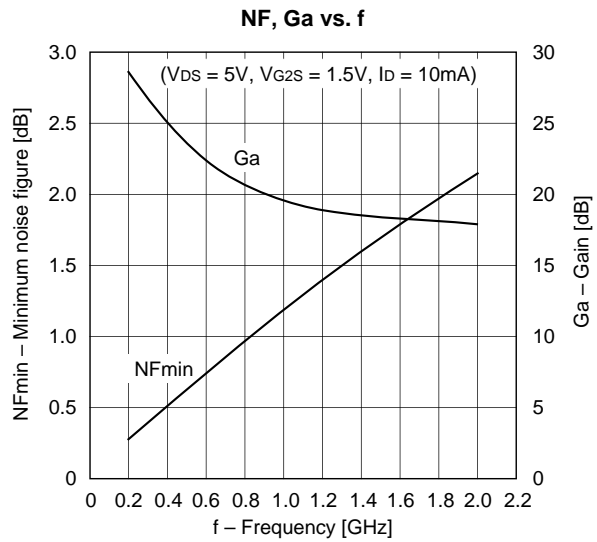
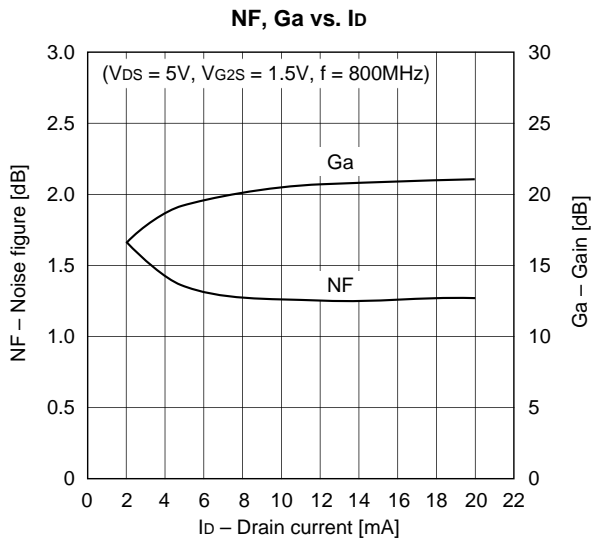
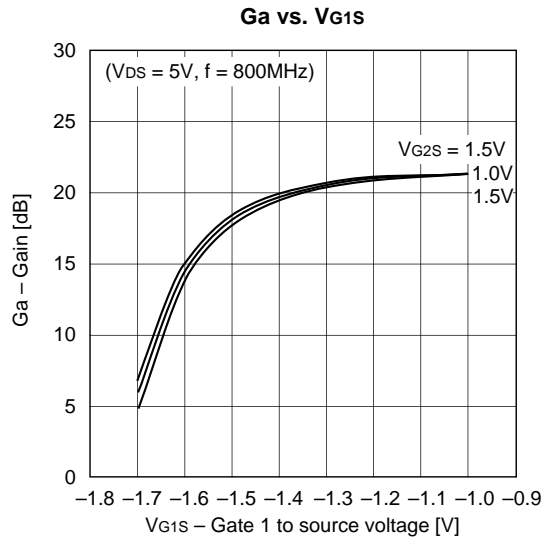
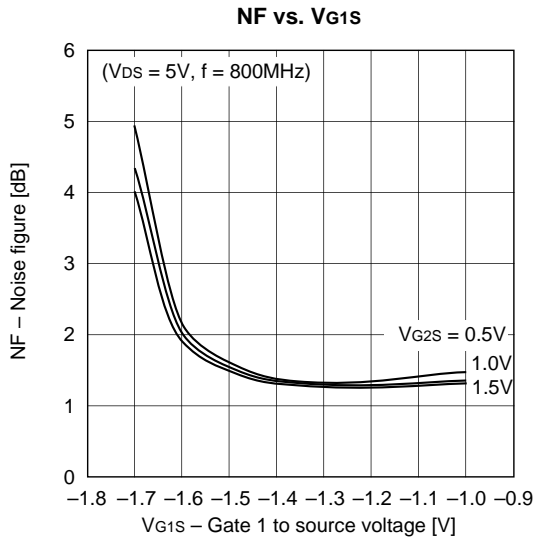
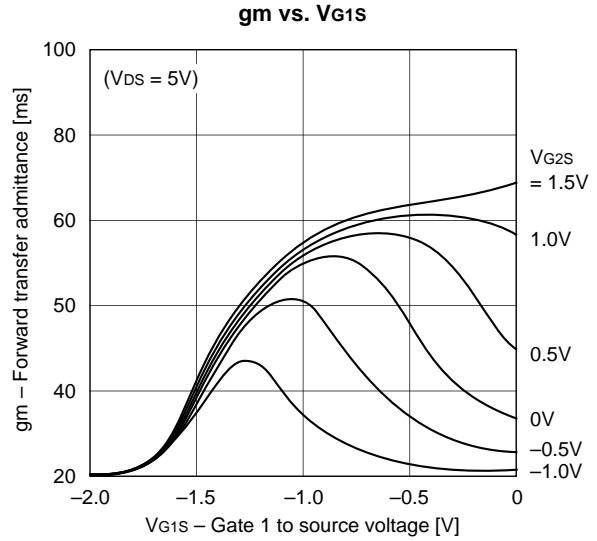
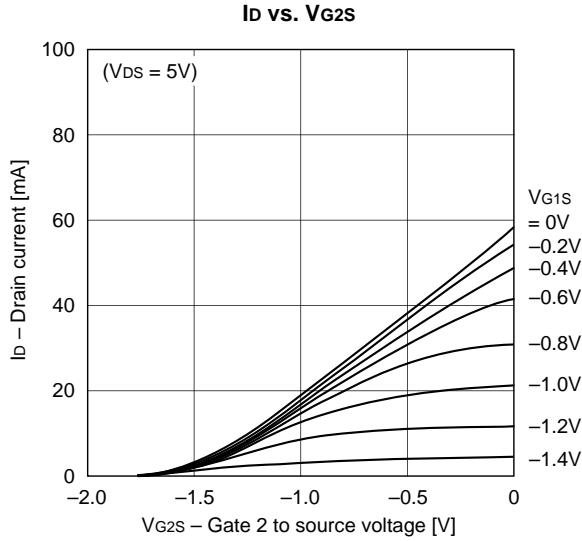

S-parameter vs. Frequency Characteristics ($V_{DS} = 5V$, $V_{G2S} = 1.5V$, $I_D = 10mA$) $(Z_0 = 50\Omega)$

f (MHz)	S11		S21		S12		S22	
	MAG	ANG	MAG	ANG	MAG	ANG	MAG	ANG
100	0.996	-5.0	3.807	172.8	0.002	86.5	0.936	-1.9
200	0.988	-9.8	3.783	165.5	0.005	87.7	0.933	-4.0
300	0.969	-14.8	3.726	158.4	0.007	87.3	0.930	-6.1
400	0.948	-19.8	3.670	151.5	0.009	85.6	0.927	-8.2
500	0.927	-24.6	3.602	144.5	0.010	81.9	0.925	-10.2
600	0.899	-29.3	3.507	137.9	0.011	84.3	0.922	-12.1
700	0.873	-33.5	3.414	131.4	0.013	83.5	0.923	-14.2
800	0.845	-37.5	3.333	125.2	0.013	82.3	0.921	-16.3
900	0.816	-41.2	3.244	118.9	0.015	86.3	0.926	-18.2
1000	0.785	-44.5	3.146	112.8	0.016	86.8	0.924	-20.3
1100	0.754	-47.6	3.061	106.9	0.016	88.0	0.920	-22.3
1200	0.723	-50.3	2.965	101.2	0.016	92.4	0.921	-24.4
1300	0.694	-53.2	2.874	95.4	0.017	95.8	0.921	-26.5
1400	0.669	-55.6	2.800	90.0	0.017	97.9	0.924	-28.9
1500	0.643	-58.1	2.709	84.2	0.018	103.3	0.925	-31.4
1600	0.621	-60.4	2.636	78.5	0.018	111.5	0.926	-33.9
1700	0.601	-62.3	2.545	72.8	0.020	119.2	0.927	-36.9
1800	0.583	-64.5	2.464	67.0	0.022	129.3	0.924	-39.5
1900	0.565	-66.6	2.364	61.3	0.026	132.1	0.915	-42.4
2000	0.545	-68.1	2.283	55.8	0.028	136.6	0.912	-45.0

Noise Figure Characteristics ($V_{DS} = 5V$, $V_{G2S} = 1.5V$, $I_D = 10mA$)

f (MHz)	NFmin (dB)	Gamma Optimum		Rn (Ω)
		ANG	MAG	
200	0.29	0.89	7.3	30.3
300	0.41	0.85	10.6	29.7
400	0.52	0.81	13.7	29.2
500	0.64	0.77	16.7	28.7
600	0.75	0.73	19.5	28.3
700	0.86	0.70	22.3	27.8
800	0.97	0.67	24.9	27.4
900	1.07	0.64	27.5	27.0
1000	1.18	0.61	30.1	26.7
1100	1.28	0.59	32.6	26.3
1200	1.39	0.57	35.2	26.0
1300	1.49	0.54	37.8	25.8
1400	1.59	0.52	40.5	25.5
1500	1.68	0.50	43.3	25.3
1600	1.78	0.48	46.3	25.1
1700	1.88	0.45	49.3	25.0
1800	1.97	0.43	52.6	24.9
1900	2.06	0.40	56.0	24.8
2000	2.15	0.38	59.7	24.7

Package Outline

Unit: mm

M-254

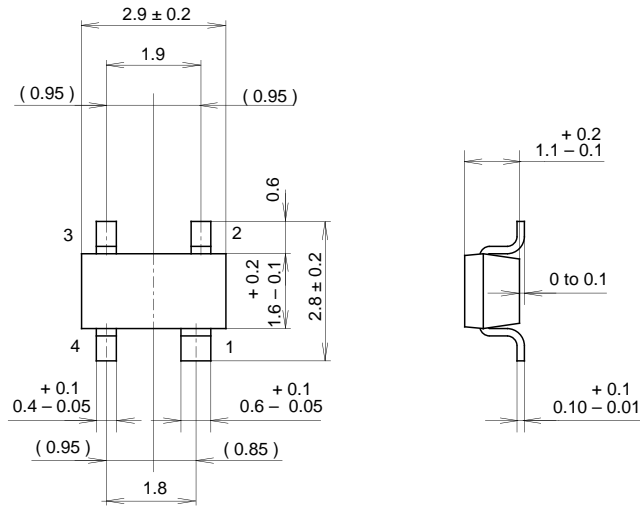

- 1. Source
- 2. Gate1
- 3. Gate2
- 4. Drain

SONY CODE	M-254
EIAJ CODE	_____
JEDEC CODE	_____

PACKAGE MASS	0.01g
--------------	-------